

the spoken
qualität quality
über die man spricht

www.akko.com.tr

€ **Price List**
Preis Liste
01.09.2018









 **AKKO®**





We as AKKO Oto. Mak. Hird. San. Tic. Ltd. Şti, which has been founded by Abdullah KARAKUŞ in 1986, produce Turning Tool Holders, Threading and Grooving Tool Holders, U-Drills, Milling Tool Holders and Precision Tool Holders (OEM Tool Holders). We produce standard 7000 kinds of tool holders with production capacity of 300.000 pieces per annum in an area about 8000 square meter. We are going on exporting 70 countries including European, Asian, African, Asian, South American Countries and Middle East Countries. We keep ready about 200.000 pieces produced products in our stock. Steel Raw materials that we make produced especially for us are delivered our factory and all production process are made in our factory. All kind of process from machining of steel to heat treatment and coating on our tools are made in our integrated factory AKKO.





Die Fa.Akko, die 1986 von Abdullah Karakus gegründet wurde, produziert Drehhalter für ISO-Wendeplatten, Gewindedrehhalter, Stechwerkzeuge, Wendeplattenbohrer, Fräswerkzeuge und Präzisionswendeplattenwerkzeuge (OEM). Auf 8000 m² fertigen wir 7000 verschiedene Artikel mit einer Gesamtkapazität von 300.000 Stück pro Jahr. Wir exportieren unsere Produkte weltweit in 70 verschiedene Länder und beliefern unsere Kunden in Europa, Asien, Afrika, Südamerika und Mittlerer Osten. Unser Lagerbestand beträgt ca.200.000 Stück. Das von uns verarbeitete Rohmaterial wird speziell für uns gefertigt und alle Fertigungsschritte werden in unserer eigenen Produktion durchgeführt. Dazu zählen die mechanische Bearbeitung, die Wärmebehandlung und die Beschichtung.

T - SYSTEM EXTERNAL TURNING TOOLHOLDERS / AUBEN - DREHHALTER			PRICE / PREIS
 <p>TCBNR / L CNM. 1606..</p> <p>75°</p>	2525 M16	61,00 €	
 <p>TCKNR / L CNM. 1204.. CNM. 1606..</p> <p>75°</p>	2020 K12	58,00 €	
	2525 M12	59,00 €	
	2525 M16	61,00 €	
	3232 P12	67,00 €	
	3232 P16	70,00 €	
 <p>TCLNR / L CNM. 1204.. CNM. 1606..</p> <p>95°</p>	2020 K12	58,00 €	
	2525 M12	59,00 €	
	3232 P12	67,00 €	
	4040 S12	112,00 €	
	5050 S12	158,00 €	
	2525 M16	61,00 €	
	3232 P16	70,00 €	
 <p>TCMNN CNM. 1204.. CNM. 1606..</p> <p>50°</p>	1616 H12	57,00 €	
	2020 K12	58,00 €	
	2525 M12	59,00 €	
	3232 P12	67,00 €	
	2525 M16	61,00 €	
	3232 P16	70,00 €	
 <p>TCZNN CNM. 1204.. CNM. 1606..</p> <p>40°</p>	2020 K12	58,00 €	
	2525 M12	59,00 €	
	3232 P12	67,00 €	
	2525 M16	61,00 €	
	3232 P16	70,00 €	
 <p>TDHNR / L DNM. 1104.. DNM. 1506..</p> <p>107.5°</p>	^{NEW} 2525 M11	59,00 €	
	2020 K15	58,00 €	
	2525 M15	59,00 €	
	3232 P15	67,00 €	

T - SYSTEM EXTERNAL TURNING TOOLHOLDERS / AUBEN - DREHHALTER			PRICE / PREIS
 <p>TDJNR / L DNM. 1104.. DNM. 1504.. DNM. 1506..</p> <p>93°</p>	1616 H11	57,00 €	
	2020 K11	58,00 €	
	2525 M11	59,00 €	
	2020 K15	58,00 €	
	2525 M15	59,00 €	
	3232 P15	67,00 €	
	4040 S15	112,00 €	
	2020 K1504	58,00 €	
	2525 M1504	59,00 €	
	3232 P1504	67,00 €	
	4040 S1504	112,00 €	
 <p>TDNNN DNM. 1104.. DNM. 1506..</p> <p>62.5°</p>	1616 H11	57,00 €	
	2020 K11	58,00 €	
	2525 M11	59,00 €	
	2020 K15	58,00 €	
	2525 M15	59,00 €	
	3232 P15	67,00 €	
 <p>TSDNN SNM. 1204.. SNM. 1506..</p> <p>45°</p>	1616 H12	57,00 €	
	2020 K12	58,00 €	
	2525 M12	59,00 €	
	3232 P12	67,00 €	
	NEW 3232 P15	70,00 €	
 <p>TSKNR / L SNM. 1204.. SNM. 1506..</p> <p>75°</p>	2020 K12	58,00 €	
	2525 M12	59,00 €	
	3232 P12	67,00 €	
	3232 P15	70,00 €	
 <p>TSSNR / L SNM. 1204.. SNM. 1506..</p> <p>45°</p>	2020 K12	58,00 €	
	2525 M12	59,00 €	
	3232 P12	67,00 €	
	2525 M15	61,00 €	
	3232 P15	70,00 €	

T - SYSTEM EXTERNAL TURNING TOOLHOLDERS / AUBEN - DREHHALTER			PRICE / PREIS
 <p>TTENN</p> <p>TNM. 1604.. TNM. 2204..</p> <p>60°</p>	2020 K16	58,00 €	
	2525 M16	59,00 €	
	3232 P16	67,00 €	
	2525 M22	59,00 €	
	3232 P22	67,00 €	
 <p>TTGNR / L</p> <p>TNM. 1604.. TNM. 2204..</p> <p>90°</p>	2020 K16	58,00 €	
	2525 M16	59,00 €	
	3232 P16	67,00 €	
	2525 M22	59,00 €	
	3232 P22	67,00 €	
 <p>TTJNR / L</p> <p>TNM. 1604.. TNM. 2204..</p> <p>93°</p>	2020 K16	58,00 €	
	2525 M16	59,00 €	
	3232 P16	67,00 €	
	2525 M22	59,00 €	
	3232 P22	67,00 €	
 <p>TVHNR / L</p> <p>VNM. 1604..</p> <p>107.5°</p>	2020 K16	58,00 €	
	2525 M16	59,00 €	
	3232 P16	67,00 €	
 <p>TVJNR / L</p> <p>VNM. 1604..</p> <p>93°</p>	2020 K16	58,00 €	
	2525 M16	59,00 €	
	3232 P16	67,00 €	
 <p>TVVNN</p> <p>VNM. 1604..</p> <p>72.5°</p>	2020 K16	58,00 €	
	2525 M16	59,00 €	
	3232 P16	67,00 €	

T - SYSTEM EXTERNAL TURNING TOOLHOLDERS / AUBEN - DREHHALTER		PRICE / PREIS
 <p>TWLNR / L WNM. 0604.. WNM. 0804..</p> <p>95°</p>	1616 H06	57,00 €
	2020 K06	58,00 €
	2525 M06	59,00 €
	2020 K08	58,00 €
	2525 M08	59,00 €
	3232 P08	67,00 €
	4040 S08	112,00 €





M - SYSTEM EXTERNAL TURNING TOOLHOLDERS / AUBEN - DREHHALTER		PRICE / PREIS
 <p>MTENN TNM. 1604.. TNM. 2204..</p> <p>60°</p>	2020 K16	58,00 €
	2525 M16	59,00 €
	3232 P16	67,00 €
	2525 M22	59,00 €
	3232 P22	67,00 €
	4040 S22	112,00 €

 <p>MTJNR / L TNM. 1604.. TNM. 2204..</p> <p>93°</p>	2020 K16	58,00 €
	2525 M16	59,00 €
	3232 P16	67,00 €
	2525 M22	59,00 €
	3232 P22	67,00 €
	4040 S22	112,00 €

 <p>MWLNR / L WNM. 0604.. WNM. 0804..</p> <p>95°</p>	1616 H06	57,00 €
	2020 K06	58,00 €
	2525 M06	59,00 €
	2020 K08	58,00 €
	2525 M08	59,00 €
	3232 P08	67,00 €

 <p>MWMNN WNM. 0604.. WNM. 0804..</p> <p>50°</p>	1616 H06	57,00 €
	2020 K06	58,00 €
	2525 M06	59,00 €
	2020 K08	58,00 €
	2525 M08	59,00 €
	3232 P08	67,00 €

P - SYSTEM EXTERNAL TURNING TOOLHOLDERS / AUßEN - DREHHALTER			PRICE / PREIS
 <p>PCBNR / L</p> <p>CNM. 1204.. CNM. 1606.. CNM. 1906.. CNM. 2509..</p> <p>75°</p>		2020 K12C	58,00 €
		2525 M12C	59,00 €
		3232 P12C	67,00 €
		2525 M16C	61,00 €
		3232 P16C	70,00 €
		3232 P19C	88,00 €
		4040 S19C	118,00 €
	4040 S25C	129,00 €	
 <p>PCLNR / L</p> <p>CNM. 0903.. CNM. 1204.. CNM. 1606.. CNM. 1906.. CNM. 2509..</p> <p>95°</p>		1616 H09	57,00 €
		2020 K09	58,00 €
		2525 M09	59,00 €
		1616 H12	57,00 €
		2020 K12C	58,00 €
		2525 M12C	59,00 €
		3232 P12C	67,00 €
		2525 M16C	61,00 €
		3232 P16C	70,00 €
		2525 M19C	79,00 €
		3232 P19C	88,00 €
		4040 S19C	118,00 €
		4040 S25C	129,00 €
		5050 S25C	171,00 €
 <p>PCMNN</p> <p>CNM. 1204.. CNM. 1906.. CNM. 2509..</p> <p>50°</p>		2020 K12C	58,00 €
		2525 M12C	59,00 €
		3232 P19C	88,00 €
		NEW 4040 S19C	118,00 €
		4040 S25C	129,00 €
 <p>PDJNR / L</p> <p>DNM. 1104.. DNM. 1506..</p> <p>93°</p>		1616 H11	57,00 €
		2020 K11	58,00 €
		2525 M11	59,00 €
		2020 K15C	58,00 €
		2525 M15C	59,00 €
		3232 P15C	67,00 €
		4040 S15C	112,00 €
 <p>PDNNN</p> <p>DNM. 1104.. DNM. 1506..</p> <p>62.5°</p>		1616 H11	57,00 €
		2020 K11	58,00 €
		2525 M11	59,00 €
		2020 K15C	58,00 €
		2525 M15C	59,00 €
		3232 P15C	67,00 €

P - SYSTEM EXTERNAL TURNING TOOLHOLDERS / AUßEN - DREHHALTER		PRICE / PREIS
 <p>PSBNR / L</p> <p>SNM. 0903.. SNM. 1204.. SNM. 1506.. SNM. 1906.. SNM. 2509..</p> <p>75°</p>	1616 H09	57,00 €
	2020 K12	58,00 €
	2525 M12C	59,00 €
	3232 P12C	67,00 €
	2525 M15C	61,00 €
	3232 P15C	70,00 €
	3232 P19C	88,00 €
	4040 S19C	118,00 €
	4040 S25C	129,00 €
	5050 S25C	171,00 €
 <p>PSDNN</p> <p>SNM. 0903.. SNM. 1204.. SNM. 1506.. SNM. 1906.. SNM. 2509..</p> <p>45°</p>	1616 H09	57,00 €
	2020 K12C	58,00 €
	2525 M12C	59,00 €
	3232 P12C	67,00 €
	2525 M15C	61,00 €
	3232 P19C	88,00 €
	4040 S25C	129,00 €
 <p>PSKNR / L</p> <p>SNM. 0903.. SNM. 1204.. SNM. 1506.. SNM. 1906.. SNM. 2509..</p> <p>75°</p>	2020 K09	58,00 €
	2020 K12C	58,00 €
	2525 M12C	59,00 €
	3232 P12C	67,00 €
	2525 M15C	61,00 €
	3232 P15C	70,00 €
	3232 P19C	88,00 €
	4040 S19C	118,00 €
	4040 S25C	129,00 €
	5050 S25C	171,00 €
 <p>PSSNR / L</p> <p>SNM. 0903.. SNM. 1204.. SNM. 1906.. SNM. 2509..</p> <p>45°</p>	1616 H09	57,00 €
	2020 K09	58,00 €
	2020 K12C	58,00 €
	2525 M12C	59,00 €
	3232 P12C	67,00 €
	3232 P19C	88,00 €
	4040 S19C	118,00 €
	4040 S25C	129,00 €
 <p>PTFNR / L</p> <p>TNM. 1604.. TNM. 2204..</p> <p>90°</p>	1616 H16	57,00 €
	2020 K16	58,00 €
	2525 M16	59,00 €
	3232 P16	67,00 €
	2525 M22C	59,00 €
	3232 P22C	67,00 €

P - SYSTEM EXTERNAL TURNING TOOLHOLDERS / AUßEN - DREHHALTER			PRICE / PREIS
 <p style="text-align: right;">90°</p>	PTGNR / L TNM. 1604.. TNM. 2204..	1616 H16	57,00 €
		2020 K16	58,00 €
		2525 M16	59,00 €
		2525 M22C	59,00 €
		3232 P22C	67,00 €
 <p style="text-align: right;">93°</p>	PTJNR / L TNM. 1604.. TNM. 2204..	1616 H16	57,00 €
		2020 K16	58,00 €
		2525 M16	59,00 €
		3232 P16	67,00 €
		2525 M22C	59,00 €
		3232 P22C	67,00 €
 <p style="text-align: right;">60°</p>	PTTNR / L TNM. 1604.. TNM. 2204..	1616 H16	57,00 €
		2020 K16	58,00 €
		2525 M16	59,00 €
		3232 P16	67,00 €
		2525 M22C	59,00 €
		3232 P22C	67,00 €
 <p style="text-align: right;">95°</p>	PWLNR / L WNM. 0604.. WNM. 0804..	1616 H06	57,00 €
		2020 K06	58,00 €
		2525 M06	59,00 €
		1616 H08	57,00 €
		2020 K08C	58,00 €
		2525 M08C	59,00 €
		3232 P08C	67,00 €
 <p style="text-align: right;">93°</p>	CKJNR / L KNUX 1604..	2020 K16	58,00 €
		2525 M16	59,00 €
		3232 P16	67,00 €
		4040 S16	129,00 €

C - SYSTEM EXTERNAL TURNING TOOLHOLDERS FOR CERAMIC INSERTS / AUBEN - DREHHALTER - FÜR KERAMIK WENDESCHNEIDPLATTEN			PRICE / PREIS
 <p>CCLNR / L CN.N 1207.. CN.N 1607..</p> <p>95°</p>	2525 M1207C	80,00 €	
	3232 P1207C	90,00 €	
	2525 M1607C	89,00 €	
 <p>CDJNR / L DN.N 1107.. DN.N 1507..</p> <p>93°</p>	2525 M1107C	80,00 €	
	2525 M1507C	80,00 €	
	3232 P1507C	90,00 €	
 <p>CDNNN DN.N 1107..</p> <p>62.5°</p>	2525 M1107C	80,00 €	
 <p>CRDCN RCGX 060600 RCGX 090700 RCGX 120700</p> <p>R</p>	2525 M06CV	117,00 €	
	3225 P06CV	128,00 €	
	4040 S06CV	163,00 €	
	2525 M09CV	117,00 €	
	3225 P09CV	128,00 €	
	4040 S09CV	163,00 €	
	2525 M12CV	117,00 €	
	3225 P12CV	128,00 €	
4040 S12CV	163,00 €		
 <p>CSDNN SN.N 1207..</p> <p>45°</p>	2525 M1207C	80,00 €	
	3232 P1207C	90,00 €	
 <p>CSKNR / L SN.N 1207..</p> <p>75°</p>	2525 M1207C	80,00 €	
	3232 P1207C	90,00 €	

C - SYSTEM EXTERNAL TURNING TOOLHOLDERS FOR CERAMIC INSERTS / AUßEN - DREHHALTER - FÜR KERAMIK WENDESCHNEIDPLATTEN			PRICE / PREIS
 <p>CSRNR / L SN.N 1207..</p> <p>45°</p>	2525 M1207C	80,00 €	
	3232 P1207C	90,00 €	
 <p>CSSNR / L SN.N 1207..</p> <p>45°</p>	2525 M1207C	80,00 €	
	3232 P1207C	90,00 €	
 <p>CTJNR / L TN.N 1607..</p> <p>93°</p>	2525 M1607C	80,00 €	
	3232 P1607C	90,00 €	
S - SYSTEM EXTERNAL TURNING TOOLHOLDERS / AUßEN - DREHHALTER			PRICE / PREIS
 <p>SCACR / L CC.T 0602.. CC.T 09T3.. CC.T 1204..</p> <p>90°</p>	0808 E06	35,00 €	
	1010 E06	35,00 €	
	1212 F09	35,00 €	
	1616 H09	39,00 €	
	2020 K09	41,00 €	
	2020 K12	41,00 €	
	2525 M12-Z	41,00 €	
	2525 M12	43,00 €	
 <p>SCLCR / L CC.T 0602.. CC.T 09T3.. CC.T 1204..</p> <p>95°</p>	0808 E06	35,00 €	
	1010 E06	35,00 €	
	<small>NEW</small> 1010 E09	35,00 €	
	1212 F09	35,00 €	
	1616 H09	39,00 €	
	2020 K09	41,00 €	
	2525 M09	43,00 €	
	<small>NEW</small> 1616 H12	39,00 €	
	2020 K12-Z	39,00 €	
	2020 K12	41,00 €	
	2525 M12-Z	41,00 €	
2525 M12	43,00 €		
 <p>SCMCN CC.T 0602.. CC.T 09T3.. CC.T 1204..</p> <p>50°</p>	0808 E06	35,00 €	
	1010 E06	35,00 €	
	1212 F06	35,00 €	
	1212 F09	35,00 €	
	1616 H09	39,00 €	
	2020 K12	41,00 €	
	2525 M12	43,00 €	



S - SYSTEM EXTERNAL TURNING TOOLHOLDERS / AUßEN - DREHHALTER			PRICE / PREIS
 <p>107.5°</p>	SDHCR / L DC.T 0702.. DC.T 11T3..	0808 E07	35,00 €
		1010 E07	35,00 €
		1212 F07	35,00 €
		1616 H07	35,00 €
		1616 H11	39,00 €
		2020 K11	41,00 €
		2525 M11	43,00 €
		3232 P11	49,00 €
 <p>93°</p>	SDJCR / L DC.T 0702.. DC.T 11T3..	0808 E07	35,00 €
		1010 E07	35,00 €
		1212 F07	35,00 €
		1616 H07	35,00 €
		1616 H11	39,00 €
		2020 K11	41,00 €
		2525 M11	43,00 €
		3232 P11	49,00 €
 <p>62.5°</p>	SDNCN DC.T 0702.. DC.T 11T3..	0808 E07	35,00 €
		1010 E07	35,00 €
		1212 F07	35,00 €
		1616 H07	35,00 €
		1616 H11	39,00 €
		2020 K11	41,00 €
		2525 M11	43,00 €
		3232 P11	49,00 €
 <p>R</p>	SRDCN RC.T 0602.. RC.T 0803.. RC.T 10T3.. RC.T 1204.. RC.T 1605.. RC.T 2006.. RC.T 2507.. RC.T 3209..	1616 H06	39,00 €
		2020 K06	41,00 €
		2525 M06	43,00 €
		1616 H08C	39,00 €
		2020 K08C	41,00 €
		2525 M08C	43,00 €
		1616 H10C	39,00 €
		2020 K10C	41,00 €
		2525 M10C	43,00 €
		3232 P10C	49,00 €
		2020 K12C	41,00 €
		2525 M12C	43,00 €
		3232 P12C	49,00 €
		2525 M16C	46,00 €
		3232 P16C	52,00 €
		2525 M20C	90,00 €
		3232 P20C	106,00 €
		3232 P25C	106,00 €
		3232 P32C	106,00 €



S - SYSTEM EXTERNAL TURNING TOOLHOLDERS / AUßEN - DREHHALTER			PRICE / PREIS
 <p style="text-align: right;">R</p>	SRDCR / L RC.T 1204..	3232 P12C	49,00 €
 <p style="text-align: right;">R</p>	SRGCR / L RC.T 0602.. RC.T 0803.. RC.T 10T3.. RC.T 1204..	1616 H06 2020 K06 1616 H08C 2020 K08C 2525 M08C 1616 H10C 2020 K10C 2525 M10C 3232 P10C 2020 K12C 2525 M12C 3232 P12C	39,00 € 41,00 € 39,00 € 41,00 € 43,00 € 39,00 € 41,00 € 43,00 € 49,00 € 41,00 € 43,00 € 49,00 €
 <p style="text-align: right;">R</p>	SRHCR / L RC.T 0602.. RC.T 0803.. RC.T 10T3.. RC.T 1204.. RC.T 1606..	<small>NEW</small> 2525 K06 2525 K08 2525 K10 2525 K12 2525 K16	112,00 € 112,00 € 112,00 € 112,00 € 112,00 €
 <p style="text-align: right;">R</p>	SRXCR / L RC.T 0803.. RC.T 10T3.. RC.T 1204..	3232 X08C 3232 X10C 3232 X12C	109,00 € 109,00 € 109,00 €
 <p style="text-align: right;">45°</p>	SSDCN SC.T 09T3.. SC.T 1204.. SC.T 1605..	1212 F09 1616 H09-Z 1616 H09 2020 K09-Z 2020 K09 1616 H12-Z 1616 H12 2020 K12 2525 M12 2020 K16-Z	35,00 € 35,00 € 39,00 € 39,00 € 41,00 € 35,00 € 39,00 € 41,00 € 43,00 € 39,00 €







S - SYSTEM EXTERNAL TURNING TOOLHOLDERS / AUßEN - DREHHALTER			PRICE / PREIS
 <p>SSSCR / L</p> <p>SC.T 09T3.. SC.T 1204..</p> <p>45°</p>	1212 F09	35,00 €	
	1616 H09-Z	35,00 €	
	1616 H09	39,00 €	
	2020 K09-Z	39,00 €	
	2020 K09	41,00 €	
	1616 H12	39,00 €	
	2020 K12-Z	39,00 €	
	2020 K12	41,00 €	
	2525 M12-Z	41,00 €	
	2525 M12	43,00 €	
 <p>STFCR / L</p> <p>TC.T 0902.. TC.T 1102.. TC.T 16T3..</p> <p>90°</p>	0808 E09	35,00 €	
	1010 E09	35,00 €	
	1212 F11	35,00 €	
	1616 H11	35,00 €	
	1616 H16	39,00 €	
	2020 K16	41,00 €	
	2525 M16	43,00 €	
	3232 P16	49,00 €	
	 <p>STGCR / L</p> <p>TC.T 0902.. TC.T 1102.. TC.T 16T3..</p> <p>90°</p>	0808 E09	35,00 €
1010 E09		35,00 €	
1212 F11		35,00 €	
1616 H11		35,00 €	
1616 H16		39,00 €	
2020 K16		41,00 €	
2525 M16		43,00 €	
3232 P16		49,00 €	
 <p>STJCR / L</p> <p>TC.T 0902.. TC.T 1102.. TC.T 16T3..</p> <p>93°</p>		0808 E09	35,00 €
	1010 E09	35,00 €	
	1212 F11	35,00 €	
	1616 H11	35,00 €	
	1616 H16	39,00 €	
	2020 K16	41,00 €	
	2525 M16	43,00 €	
	3232 P16	49,00 €	
	 <p>STCCN</p> <p>TC.T 1102.. TC.T 16T3.. TC.T 2204..</p> <p>90°</p>	2020 L11	66,00 €
1616 K16		61,00 €	
2020 M16		66,00 €	
2525 P16		71,00 €	
3232 R16		80,00 €	
2525 P22		71,00 €	
 <p>STUCR / L</p> <p>TC.T 0902.. TC.T 1102.. TC.T 16T3..</p> <p>93°</p>	0808 E09	35,00 €	
	1010 E09	35,00 €	
	1212 F11	35,00 €	
	1616 H11	35,00 €	
	2020 K16	41,00 €	
	2525 M16	43,00 €	
	3232 P16	49,00 €	

S - SYSTEM EXTERNAL TURNING TOOLHOLDERS / AUßEN - DREHHALTER			PRICE / PREIS
 <p>SVHBR / L VBM. 1103.. VBM. 1604..</p> <p>107.5°</p>	1212 F11	35,00 €	
	1616 H11	35,00 €	
	2020 K11	39,00 €	
	2020 K16	41,00 €	
	2525 M16	43,00 €	
	3232 P16	49,00 €	
 <p>SVHCR / L VC.T 1103.. VC.T 1604..</p> <p>107.5°</p>	1212 F11	35,00 €	
	1616 H11	35,00 €	
	2020 K11	39,00 €	
	2020 K16	41,00 €	
	2525 M16	43,00 €	
	3232 P16	49,00 €	
 <p>SVJBR / L VBM. 1103.. VBM. 1604..</p> <p>93°</p>	1212 F11	35,00 €	
	1616 H11	35,00 €	
	2020 K11	39,00 €	
	1616 H16	39,00 €	
	2020 K16	41,00 €	
	2525 M16	43,00 €	
 <p>SVJCR / L VC.T 1103.. VC.T 1604..</p> <p>93°</p>	1212 F11	35,00 €	
	1616 H11	35,00 €	
	2020 K11	39,00 €	
	1212 F16	35,00 €	
	2020 K16	41,00 €	
	2525 M16	43,00 €	
 <p>SVVBN VBM. 1103.. VBM. 1604..</p> <p>72.5°</p>	1212 F11	35,00 €	
	1616 H11	35,00 €	
	2020 K11	39,00 €	
	2020 K16	41,00 €	
	2525 M16	43,00 €	
	3232 P16	49,00 €	
 <p>SVVCN VC.T 1103.. VC.T 1604..</p> <p>72.5°</p>	1212 F11	35,00 €	
	1616 H11	35,00 €	
	2020 K11	39,00 €	
	2020 K16	41,00 €	
	2525 M16	43,00 €	
	3232 P16	49,00 €	
TOOLS FOR SWISS TYPE SLIDING AUTOMATIC LATHES / WERKZEUGE FÜR LANGDREHAUTOMATEN			PRICE / PREIS
 <p>SCACR / L CC.T 0602.. CC.T 09T3..</p> <p>90°</p>	0808 X06-S	43,00 €	
	1010 K06-S	45,00 €	
	1212 G06-S	45,00 €	
	1212 K06-S	47,00 €	
	1212 K09-S	47,00 €	
	1616 K09-S	49,00 €	
	2020 K09-S	51,00 €	

TOOLS FOR SWISS TYPE SLIDING AUTOMATIC LATHES / WERKZEUGE FÜR LANGDREHAUTOMATEN		PRICE / PREIS
 <p>SCLCR / L CC.T 0602.. CC.T 09T3..</p> <p>95°</p>	0808 X06-S	43,00 €
	1010 X06-S	43,00 €
	1212 G06-S	45,00 €
	1212 X06-S	45,00 €
	NEW 1212 K06-S	47,00 €
	1616 F06-S	47,00 €
	1616 X06-S	47,00 €
	1212 G09-S	45,00 €
	1212 X09-S	45,00 €
	1616 F09-S	47,00 €
	1616 G09-S	47,00 €
	1616 X09-S	47,00 €
	2020 X09-S	49,00 €
	 <p>SDACR / L DC.T 0702.. DC.T 11T3..</p> <p>90°</p>	0808 X07-S
1010 K07-S		45,00 €
1212 K07-S		47,00 €
NEW 1616 F07-S		47,00 €
1616 K07-S		49,00 €
1212 K11-S		47,00 €
1616 F11-S		47,00 €
1616 K11-S		49,00 €
2020 K11-S		51,00 €
 <p>SDJCR / L DC.T 0702.. DC.T 11T3..</p> <p>93°</p>		0808 X07-S
	1010 X07-S	43,00 €
	1212 G07-S	45,00 €
	1212 X07-S	45,00 €
	1616 F07-S	47,00 €
	1616 X07-S	47,00 €
	2020 X07-S	49,00 €
	1212 G11-S	45,00 €
	1212 X11-S	45,00 €
	1212 K11-S	47,00 €
	1616 F11-S	47,00 €
	1616 X11-S	47,00 €
	1616 K11-S	49,00 €
	2020 X11-S	49,00 €
 <p>STGCR / L TC.T 1102.. TC.T 16T3..</p> <p>91°</p>	1216 K11-S	49,00 €
	1616 K11-S	49,00 €
	1216 K16-S	49,00 €
	1616 K16-S	49,00 €
 <p>SVACR / L VC.T 1103.. VC.T 1604..</p> <p>90°</p>	1010 K11-S	45,00 €
	1212 K11-S	47,00 €
	1616 K11-S	49,00 €
	2020 K11-S	51,00 €
	1212 K16-S	47,00 €
	1616 K16-S	49,00 €

TOOLS FOR SWISS TYPE SLIDING AUTOMATIC LATHES / WERKZEUGE FÜR LANGDREHAUTOMATEN		PRICE / PREIS
 <p>SVJBR / L VBM. 1103..</p> <p>93°</p>	1616 K11-S	49,00 €
 <p>SVJCR / L VC.T 1103..</p> <p>93°</p>	0808 X11-S	43,00 €
	1212 K11-S	47,00 €



T - SYSTEM BORING BARS / BOHRSTANGE T-SYSTEM		PRICE / PREIS
 <p>TCLNR / L CNM. 0903.. CNM. 1204.. CNM. 1606..</p> <p>95°</p>	S25S TCLNR / L 09-Z	66,00 €
	S25S TCLNR / L 09	69,00 €
	S25S TCLNR / L 12-Z	66,00 €
	S25S TCLNR / L 12	69,00 €
	S32T TCLNR / L 12	85,00 €
	S40U TCLNR / L 12	112,00 €
	S50V TCLNR / L 12	135,00 €
	S32T TCLNR / L 16	88,00 €
	S40U TCLNR / L 16	118,00 €
	S50V TCLNR / L 16	142,00 €
 <p>TD-NR / L DNM. 1506..</p> <p>62.5°</p>	S32T TD-NR / L 15	85,00 €
	S40U TD-NR / L 15	112,00 €
	S50V TD-NR / L 15	135,00 €
 <p>TDQNR / L DNM. 1104.. DNM. 1506..</p> <p>107.5°</p>	S25S TDQNR / L 11-Z	66,00 €
	S25S TDQNR / L 11	69,00 €
	S32T TDQNR / L 11	85,00 €
	S25S TDQNR / L 15	69,00 €
	S32T TDQNR / L 15	85,00 €
	S40U TDQNR / L 15	112,00 €
	S50V TDQNR / L 15	135,00 €

T - SYSTEM BORING BARS / BOHRSTANGE T-SYSTEM			PRICE / PREIS
 <p>TDUNR / L DNM. 1104.. DNM. 1506..</p> <p>93°</p>	S25S TDUNR / L 11-Z	66,00 €	
	S25S TDUNR / L 11	69,00 €	
	S32T TDUNR / L 11	85,00 €	
	S25S TDUNR / L 15	69,00 €	
	S32T TDUNR / L 15	85,00 €	
	S40U TDUNR / L 15	112,00 €	
	S50V TDUNR / L 15	135,00 €	
 <p>TSKNR / L SNM. 1204..</p> <p>75°</p>	S25S TSKNR / L 12-Z	66,00 €	
	S25S TSKNR / L 12	69,00 €	
	S32T TSKNR / L 12	85,00 €	
	S40U TSKNR / L 12	112,00 €	
 <p>TT-NR / L TNM. 1604..</p> <p>60°</p>	S25S TT-NR / L 16-Z	66,00 €	
	S25S TT-NR / L 16	69,00 €	
	S32T TT-NR / L 16	85,00 €	
 <p>TTUNR / L TNM. 1604.. TNM. 2204..</p> <p>93°</p>	S25S TTUNR / L 16-Z	66,00 €	
	S25S TTUNR / L 16	69,00 €	
	S32T TTUNR / L 16	85,00 €	
	S25S TTUNR / L 22	69,00 €	
	S32T TTUNR / L 22	85,00 €	
	S40U TTUNR / L 22	112,00 €	
	S50V TTUNR / L 22	135,00 €	
 <p>TVUNR / L VNM. 1604..</p> <p>93°</p>	S25S TVUNR / L 16	69,00 €	
	S32T TVUNR / L 16	85,00 €	
	S40U TVUNR / L 16	112,00 €	
 <p>TWLNR / L WNM. 0604.. WNM. 0804..</p> <p>95°</p>	S25S TWLNR / L 06-Z	66,00 €	
	S25S TWLNR / L 06	69,00 €	
	S32T TWLNR / L 06	85,00 €	
	S25S TWLNR / L 08-Z	66,00 €	
	S25S TWLNR / L 08	69,00 €	
	S32T TWLNR / L 08	85,00 €	
	S40U TWLNR / L 08	112,00 €	
	S50V TWLNR / L 08	135,00 €	

S25S TT-NR 16, "S": Steel Shank / Ohne Innenkühlung
S25S TT-NR 16-Z, "-Z": Without Shim / Ohne Unterlegplatte

Ordering Example/Beispiel Bestellformular: 1pcs. S25S TDUNR 11-Z





C - SYSTEM BORING BARS / BOHRSTANGE C-SYSTEM			PRICE / PREIS
 <p>CKUNR / L KNUX 1604..</p> <p>93°</p>	S25S CKUNR / L 16	69,00 €	
	S32T CKUNR / L 16	85,00 €	
	S40U CKUNR / L 16	112,00 €	
	S50V CKUNR / L 16	135,00 €	
M - SYSTEM BORING BARS / BOHRSTANGE M-SYSTEM			PRICE / PREIS
 <p>MCLNR / L CNM. 1204..</p> <p>95°</p>	S20R MCLNR / L 12	59,00 €	
	S25S MCLNR / L 12-Z	66,00 €	
	S25S MCLNR / L 12	69,00 €	
	S32T MCLNR / L 12	85,00 €	
 <p>MDUNR / L DNM. 1104.. DNM. 1506..</p> <p>93°</p>	S20R MDUNR / L 11	59,00 €	
	S25S MDUNR / L 11	66,00 €	
	S25S MDUNR / L 15-Z	66,00 €	
	S25S MDUNR / L 15	69,00 €	
	S32T MDUNR / L 15	85,00 €	
	S40U MDUNR / L 15	112,00 €	
	S50V MDUNR / L 15	135,00 €	
 <p>MTFNR / L TNM. 1604.. TNM. 2204..</p> <p>90°</p>	S20R MTFNR / L 16	59,00 €	
	S25S MTFNR / L 16	69,00 €	
	S32T MTFNR / L 16	85,00 €	
	S40U MTFNR / L 16	112,00 €	
	S32T MTFNR / L 22	85,00 €	
	S40U MTFNR / L 22	112,00 €	
	S50V MTFNR / L 22	135,00 €	
 <p>MT-NR / L TNM. 1604.. TNM. 2204..</p> <p>60°</p>	S20R MT-NR / L 16	59,00 €	
	S25S MT-NR / L 16-Z	66,00 €	
	S25S MT-NR / L 16	69,00 €	
	S32T MT-NR / L 16	85,00 €	
	S40U MT-NR / L 16	85,00 €	
	S32T MT-NR / L 22	112,00 €	
	S40U MT-NR / L 22	112,00 €	
	S50U MT-NR / L 22	135,00 €	
 <p>MTQNR / L TNM. 1604.. TNM. 2204..</p> <p>107.5°</p>	S20R MTQNR / L 16	59,00 €	
	S25S MTQNR / L 16-Z	66,00 €	
	S25S MTQNR / L 16	69,00 €	
	S32T MTQNR / L 16	85,00 €	
	S40U MTQNR / L 16	112,00 €	
	S32T MTQNR / L 22	85,00 €	
	S40U MTQNR / L 22	112,00 €	
	S50V MTQNR / L 22	135,00 €	

M - SYSTEM BORING BARS / BOHRSTANGE M-SYSTEM		PRICE / PREIS
 <p>MTUNR / L TNM. 1604.. TNM. 2204..</p> <p>93°</p>	S20R MTUNR / L 16	59,00 €
	S25S MTUNR / L 16-Z	66,00 €
	S25S MTUNR / L 16	69,00 €
	S32T MTUNR / L 16	85,00 €
	S40U MTUNR / L 16	112,00 €
	S50V MTUNR / L 16	112,00 €
	S32T MTUNR / L 22	135,00 €
	S40U MTUNR / L 22	85,00 €
	S50V MTUNR / L 22	135,00 €
 <p>MWLNR / L WNM. 0604.. WNM. 0804..</p> <p>95°</p>	S16P MWLNR / L 06	57,00 €
	S20R MWLNR / L 06	59,00 €
	S25S MWLNR / L 06	66,00 €
	S25S MWLNR / L 08-Z	66,00 €
	S25S MWLNR / L 08	69,00 €
	S32T MWLNR / L 08	85,00 €
	S40U MWLNR / L 08	112,00 €

P - SYSTEM BORING BARS / BOHRSTANGE P-SYSTEM		PRICE / PREIS
 <p>PCLNR / L CNM. 0903.. CNM. 1204.. CNM. 1606.. CNM. 1906..</p> <p>95°</p>	S16P PCLNR / L 09	57,00 €
	S20R PCLNR / L 09	59,00 €
	^{NEW} S25S PCLNR / L 09	69,00 €
	S25S PCLNR / L 12C	69,00 €
	S32T PCLNR / L 12C	85,00 €
	S40U PCLNR / L 12C	112,00 €
	S50V PCLNR / L 12C	135,00 €
	S32T PCLNR / L 16C	88,00 €
	S40U PCLNR / L 16C	118,00 €
	S50V PCLNR / L 16C	142,00 €
	S40U PCLNR / L 19C	147,00 €
	S50V PCLNR / L 19C	171,00 €
	A25R PCLNR / L 12C	85,00 €
	A32S PCLNR / L 12C	102,00 €
	A40T PCLNR / L 12C	135,00 €
	A50U PCLNR / L 12C	163,00 €
	A32S PCLNR / L 16C	106,00 €
	A40T PCLNR / L 16C	142,00 €
	A50U PCLNR / L 16C	171,00 €
	A40T PCLNR / L 19C	184,00 €
	A50U PCLNR / L 19C	204,00 €

S25S MTUNR 16-Z, "-Z": Without Shim / Ohne Unterlegplatte
 S25S PCLNR 12, "S": Steel Shank / Ohne Innenkühlung
 A25R PCLNR 12, "A": Solid Steel With Coolant Hole / Mit Innenkühlung

Ordering Example/Beispiel Bestellformular: 1pcs. S20R MTUNR 16



P - SYSTEM BORING BARS / BOHRSTANGE P-SYSTEM			PRICE / PREIS
 <p>PDQNR / L DNM. 1104.. DNM. 1504.. DNM. 1506..</p> <p>107.5°</p>	S25S PDQNR / L 11	69,00 €	
	S32T PDQNR / L 15	85,00 €	
	S40U PDQNR / L 15	112,00 €	
	S50V PDQNR / L 15	135,00 €	
	S32T PDQNR / L 1504	85,00 €	
	S40U PDQNR / L 1504	112,00 €	
	S50V PDQNR / L 1504	135,00 €	
	A20P PDQNR / L 11	70,00 €	
	A25R PDQNR / L 11	85,00 €	
	A32S PDQNR / L 15	102,00 €	
	A40T PDQNR / L 15	135,00 €	
	A50U PDQNR / L 15	163,00 €	
	A32S PDQNR / L 1504	102,00 €	
	A40T PDQNR / L 1504	135,00 €	
 <p>PDUNR / L DNM. 1104.. DNM. 1506..</p> <p>93°</p>	S20R PDUNR / L 11	59,00 €	
	S25S PDUNR / L 11	69,00 €	
	S25S PDUNR / L 15	69,00 €	
	S32T PDUNR / L 15	85,00 €	
	S40U PDUNR / L 15	112,00 €	
	S50V PDUNR / L 15	135,00 €	
	A20P PDUNR / L 11	70,00 €	
	A25R PDUNR / L 11	85,00 €	
	A32S PDUNR / L 11	102,00 €	
	A32S PDUNR / L 15	102,00 €	
	A40T PDUNR / L 15	135,00 €	
A50U PDUNR / L 15	163,00 €		
 <p>PDXNR / L DNM. 1506..</p> <p>93°</p>	S32T PDXNR / L 15	85,00 €	
	S40U PDXNR / L 15	112,00 €	
	S50V PDXNR / L 15	135,00 €	
 <p>PSKNR / L SNM. 1204.. SNM. 1506..</p> <p>75°</p>	S25S PSKNR / L 12C	69,00 €	
	S32T PSKNR / L 12C	85,00 €	
	S40U PSKNR / L 12C	112,00 €	
	S50V PSKNR / L 12C	135,00 €	
	NEW S40U PSKNR / L 15	118,00 €	
 <p>PTUNR / L TNM. 1604.. TNM. 2204..</p> <p>93°</p>	S16P PTUNR / L 16	57,00 €	
	S20R PTUNR / L 16	59,00 €	
	S25S PTUNR / L 16C	69,00 €	
	S32T PTUNR / L 16C	85,00 €	
	S40U PTUNR / L 16C	112,00 €	
	S32T PTUNR / L 22C	85,00 €	
	S40U PTUNR / L 22C	112,00 €	
	S50V PTUNR / L 22C	135,00 €	



P - SYSTEM BORING BARS / BOHRSTANGE P-SYSTEM		PRICE / PREIS
 <p>PWLNR / L WNM. 0604.. WNM. 0804..</p> <p>95°</p>	S20R PWLNR / L 06	59,00 €
	S25S PWLNR / L 06	69,00 €
	S32T PWLNR / L 06	85,00 €
	S25S PWLNR / L 08C	69,00 €
	S32T PWLNR / L 08C	85,00 €
	S40U PWLNR / L 08C	112,00 €
	S50V PWLNR / L 08C	135,00 €
	A20P PWLNR / L 06	70,00 €
	A25R PWLNR / L 06	85,00 €
	A32S PWLNR / L 06	102,00 €
	A25R PWLNR / L 08C	85,00 €
	A32S PWLNR / L 08C	102,00 €
	A40T PWLNR / L 08C	135,00 €
	A50U PWLNR / L 08C	163,00 €

S25S PWLNR 08, "S": Steel Shank / Ohne Innenkühlung
 A25R PWLNR 08, "A": Solid Steel With Coolant Hole / Mit Innenkühlung

Ordering Example/Beispiel Bestellformular: 1pcs. S20R PWLNR 06





S - SYSTEM BORING BARS / BOHRSTANGE S-SYSTEM			PRICE / PREIS
 <p>SCFCR / L</p> <p>CC.T 0602.. CC.T 09T3..</p> <p>90°</p>	S08H SCFCR / L 06	24,00 €	
	S10K SCFCR / L 06	27,00 €	
	S12K SCFCR / L 06	29,00 €	
	S12K SCFCR / L 09	29,00 €	
	S16P SCFCR / L 09	34,00 €	
	S20R SCFCR / L 09	35,00 €	
	S25S SCFCR / L 09-Z	45,00 €	
	S25S SCFCR / L 09	47,00 €	
 <p>SCLCR / L</p> <p>CC.T 0301.. CC.T 0602.. CC.T 09T3.. CC.T 1204..</p> <p>95°</p>	S0608H SCLCR / L 03	44,00 €	
	S0608H SCLCR / L 06	24,00 €	
	S08H SCLCR / L 06	24,00 €	
	S10K SCLCR / L 06	27,00 €	
	S12K SCLCR / L 06	29,00 €	
	S1216P SCLCR / L 06	34,00 €	
	S16P SCLCR / L 06	34,00 €	
	S12K SCLCR / L 09	29,00 €	
	S1416P SCLCR / L 09	34,00 €	
	S16P SCLCR / L 09	34,00 €	
	S1620R SCLCR / L 09	35,00 €	
	S20R SCLCR / L 09	35,00 €	
	S25S SCLCR / L 09-Z	45,00 €	
	S25S SCLCR / L 09	47,00 €	
	S32T SCLCR / L 09	72,00 €	
	S25S SCLCR / L 12-Z	45,00 €	
	S25S SCLCR / L 12	47,00 €	
	S32T SCLCR / L 12	72,00 €	
	S40U SCLCR / L 12	107,00 €	
	A08H SCLCR / L 06	29,00 €	
	A10H SCLCR / L 06	33,00 €	
	A12H SCLCR / L 06	35,00 €	
	A16M SCLCR / L 09	42,00 €	
	A20P SCLCR / L 09	43,00 €	
A25R SCLCR / L 09	60,00 €		
A32S SCLCR / L 09	92,00 €		
A25R SCLCR / L 12	60,00 €		
 <p>SD-CR / L</p> <p>DC.T 0702.. DC.T 11T3..</p> <p>62.5°</p>	S10K SD-CR / L 07	27,00 €	
	S12K SD-CR / L 07	29,00 €	
	S16P SD-CR / L 07	34,00 €	
	S16P SD-CR / L 11	34,00 €	
	S20R SD-CR / L 07	35,00 €	
	S20R SD-CR / L 11	35,00 €	
	S25S SD-CR / L 11-Z	45,00 €	
	S25S SD-CR / L 11	47,00 €	
	S32T SD-CR / L 11	72,00 €	
	S40U SD-CR / L 11	107,00 €	

S - SYSTEM BORING BARS / BOHRSTANGE S-SYSTEM			PRICE / PREIS
 <p>SDPCR / L DC.T 0702.. DC.T 11T3.. 117.5°</p>	S10K SDPCR / L 07	27,00 €	
	S12K SDPCR / L 07	29,00 €	
	S16P SDPCR / L 11	34,00 €	
	S20R SDPCR / L 11	35,00 €	
	S25S SDPCR / L 11	47,00 €	
 <p>SDQCR / L DC.T 0702.. DC.T 11T3.. 107.5°</p>	S10K SDQCR / L 07	27,00 €	
	S12K SDQCR / L 07	29,00 €	
	S16P SDQCR / L 07	34,00 €	
	S20R SDQCR / L 07	35,00 €	
	S16P SDQCR / L 11	34,00 €	
	S20R SDQCR / L 11	35,00 €	
	S25S SDQCR / L 11-Z	45,00 €	
	S25S SDQCR / L 11	47,00 €	
	S32T SDQCR / L 11	72,00 €	
	S40U SDQCR / L 11	107,00 €	
	A10H SDQCR / L 07	33,00 €	
	A12H SDQCR / L 07	35,00 €	
	A16M SDQCR / L 07	42,00 €	
	A20P SDQCR / L 07	43,00 €	
	A16M SDQCR / L 11	42,00 €	
	A20P SDQCR / L 11	43,00 €	
	A25R SDQCR / L 11	60,00 €	
	A32S SDQCR / L 11	92,00 €	
 <p>SDUCR / L DC.T 0702.. DC.T 11T3.. 93°</p>	S0810K SDUCR / L 07	28,00 €	
	S10K SDUCR / L 07	27,00 €	
	S12K SDUCR / L 07	29,00 €	
	S1216P SDUCR / L 07	34,00 €	
	S1416P SDUCR / L 07	34,00 €	
	S16P SDUCR / L 07	34,00 €	
	S20R SDUCR / L 07	35,00 €	
	S1416P SDUCR / L 11	34,00 €	
	S16P SDUCR / L 11	34,00 €	
	S1620R SDUCR / L 11	35,00 €	
	S20R SDUCR / L 11	35,00 €	
	S25S SDUCR / L 11-Z	45,00 €	
	S25S SDUCR / L 11	47,00 €	
	S32T SDUCR / L 11	72,00 €	
	S40U SDUCR / L 11	107,00 €	
	S50V SDUCR / L 11	129,00 €	
	A0810H SDUCR / L 07	33,00 €	
	A10H SDUCR / L 07	33,00 €	
	A12H SDUCR / L 07	35,00 €	
	A16M SDUCR / L 07	42,00 €	
	A20P SDUCR / L 07	43,00 €	
A16M SDUCR / L 11	42,00 €		
A20P SDUCR / L 11	43,00 €		
A25R SDUCR / L 11	60,00 €		
A32S SDUCR / L 11	92,00 €		







S - SYSTEM BORING BARS / BOHRSTANGE S-SYSTEM			PRICE / PREIS
 <p>SDXCR / L DC.T 0702.. DC.T 11T3..</p> <p>93°</p>	S12K SDXCR / L 07	29,00 €	
	S16P SDXCR / L 07	34,00 €	
	<small>NEW</small> S20R SDXCR / L 07	35,00 €	
	<small>NEW</small> S16P SDXCR / L 11	34,00 €	
	S20R SDXCR / L 11	35,00 €	
	S25S SDXCR / L 11-Z	45,00 €	
	S25S SDXCR / L 11	47,00 €	
	S32T SDXCR / L 11	72,00 €	
S40U SDXCR / L 11	107,00 €		
 <p>SRGCR / L RC.T 0803..</p> <p>0°</p>	S16P SRGCR / L 08	68,00 €	
	S20R SRGCR / L 08	72,00 €	
	S25S SRGCR / L 08C	98,00 €	
	S32T SRGCR / L 08C	141,00 €	
	S40U SRGCR / L 08C	206,00 €	
 <p>SSSCR / L SC.T 09T3.. SC.T 1204..</p> <p>45°</p>	S16P SSSCR / L 09	34,00 €	
	S20R SSSCR / L 09	35,00 €	
	S25S SSSCR / L 09	47,00 €	
	S25S SSSCR / L 09-Z	45,00 €	
	S25S SSSCR / L 12	47,00 €	
	S32T SSSCR / L 12	72,00 €	
	S40U SSSCR / L 12	107,00 €	
 <p>ST-CR / L TC.T 1102.. TC.T 16T3..</p> <p>60°</p>	S12K ST-CR / L 11	29,00 €	
	S16P ST-CR / L 11	34,00 €	
	S20R ST-CR / L 11	35,00 €	
	S16P ST-CR / L 16	34,00 €	
	S20R ST-CR / L 16	35,00 €	
	S25S ST-CR / L 16-Z	45,00 €	
	S25S ST-CR / L 16	47,00 €	
	S32T ST-CR / L 16	72,00 €	
	S40U ST-CR / L 16	107,00 €	
 <p>STFCR / L TC.T 06T1.. TC.T 0902.. TC.T 1102.. TC.T 16T3..</p> <p>90°</p>	S0610F STFCR / L 06	35,00 €	
	S08H STFCR / L 06	24,00 €	
	S10K STFCR / L 09	27,00 €	
	S12K STFCR / L 09	29,00 €	
	S12K STFCR / L 11	29,00 €	
	S16P STFCR / L 11	34,00 €	
	S20R STFCR / L 11	35,00 €	
	S16P STFCR / L 16	34,00 €	
	S20R STFCR / L 16	35,00 €	
	S25S STFCR / L 16-Z	45,00 €	
	S25S STFCR / L 16	47,00 €	
	S32T STFCR / L 16	72,00 €	

S - SYSTEM BORING BARS / BOHRSTANGE S-SYSTEM			PRICE / PREIS
 <p>STUCR / L</p> <p>TC.T 0902.. TC.T 1102.. TC.T 16T3..</p> <p>93°</p>	S10K STUCR / L 09	27,00 €	
	S12K STUCR / L 09	29,00 €	
	S12K STUCR / L 11	29,00 €	
	S16P STUCR / L 11	34,00 €	
	S20R STUCR / L 11	35,00 €	
	S16P STUCR / L 16	34,00 €	
	S20R STUCR / L 16	35,00 €	
	S25S STUCR / L 16-Z	45,00 €	
	S25S STUCR / L 16	47,00 €	
	S32T STUCR / L 16	72,00 €	
	S40U STUCR / L 16	107,00 €	
 <p>STUPR / L</p> <p>TP.. 0802.. TP.. 1103..</p> <p>93°</p>	S08H STUPR / L 0802	31,00 €	
	S10K STUPR / L 1103	33,00 €	
	S12K STUPR / L 1103	35,00 €	
	S12M STUPR / L 1103	40,00 €	
	S16P STUPR / L 1103	41,00 €	
	S16R STUPR / L 1103	49,00 €	
 <p>SVJBR / L</p> <p>VBM. 1604..</p> <p>93°</p>	S25S SVJBR / L 16	57,00 €	
	S32T SVJBR / L 16	72,00 €	
	S40U SVJBR / L 16	107,00 €	
 <p>SVQBR / L</p> <p>VBM. 1103.. VBM. 1604..</p> <p>107.5°</p>	S16P SVQBR / L 11	34,00 €	
	S20R SVQBR / L 11	35,00 €	
	S25S SVQBR / L 16-Z	54,00 €	
	S25S SVQBR / L 16	57,00 €	
	S32T SVQBR / L 16	72,00 €	
	S40U SVQBR / L 16	107,00 €	
	NEW A20Q SVQBR / L 11	43,00 €	
	NEW A20Q SVQBR / L 16	43,00 €	
NEW A25S SVQBR / L 16	57,00 €		
NEW A32S SVQBR / L 16	62,00 €		
 <p>SVQCR / L</p> <p>VC.T 1103.. VC.T 1604..</p> <p>107.5°</p>	S16P SVQCR / L 11	34,00 €	
	S20R SVQCR / L 11	35,00 €	
	S25S SVQCR / L 16-Z	54,00 €	
	S25S SVQCR / L 16	57,00 €	
	S32T SVQCR / L 16	72,00 €	
	S40U SVQCR / L 16	107,00 €	

S - SYSTEM BORING BARS / BOHRSTANGE S-SYSTEM			PRICE / PREIS
 <p>SVUBR / L VBM. 1103.. VBM. 1604..</p> <p>93°</p>	S16P SVUBR / L 11	34,00 €	
	S20R SVUBR / L 11	35,00 €	
	S25S SVUBR / L 16-Z	54,00 €	
	S25S SVUBR / L 16	57,00 €	
	S32T SVUBR / L 16	72,00 €	
	S40U SVUBR / L 16	107,00 €	
	NEW A20Q SVUBR / L 16	43,00 €	
	NEW A32S SVUBR / L 16	62,00 €	
 <p>SVUCR / L VC.T 1103.. VC.T 1604..</p> <p>93°</p>	S16P SVUCR / L 11	34,00 €	
	S20R SVUCR / L 11	35,00 €	
	S25S SVUCR / L 16-Z	54,00 €	
	S25S SVUCR / L 16	57,00 €	
	S32T SVUCR / L 16	72,00 €	
	S40U SVUCR / L 16	107,00 €	
 <p>SVXBR / L VBM. 1102.. VBM. 1103.. VBM. 1604..</p> <p>93°</p>	S16P SVXBR / L 1102	52,00 €	
	S20R SVXBR / L 1102	54,00 €	
	S16P SVXBR / L 11	34,00 €	
	S20R SVXBR / L 11	35,00 €	
	S25S SVXBR / L 16	57,00 €	
	S32T SVXBR / L 16	72,00 €	
	S40U SVXBR / L 16	107,00 €	
 <p>SVJCR / L VC.T 1103..</p> <p>93°</p>	S12K SVJCR / L 11	35,00 €	
	S16P SVJCR / L 11	41,00 €	
	S20R SVJCR / L 11	42,00 €	
 <p>SWLCR WC.. 0302..</p> <p>95°</p>	S0608H SWLCR 03	24,00 €	
	S0810K SWLCR 03	27,00 €	
 <p>SWUBR WBGT 060102-L</p> <p>93°</p>	S08H SWUBR 06-5.5	32,00 €	
	S08H SWUBR 06-7	32,00 €	
	S0610H SWUBR 06	40,00 €	
S-SYSTEM BORING BARS WITH CARBIDE SHANK / BOHRSTANGE MIT VOLLHARTMETALLSCHAFT			PRICE / PREIS
 <p>SCLCR / L CC.T 0602.. CC.T 09T3..</p> <p>95°</p>	E08K SCLCR / L 06	161,00 €	
	E10M SCLCR / L 06	216,00 €	
	E12Q SCLCR / L 06	268,00 €	
	E16R SCLCR / L 09	321,00 €	
	NEW E20S SCLCR / L 09	612,00 €	

S-SYSTEM BORING BARS WITH CARBIDE SHANK / BOHRSTANGE MIT VOLLHARTMETALLSCHAFT			PRICE / PREIS
 <p>SDUCR / L DC.T 0702.. DC.T 11T3..</p> <p>93°</p>	E10M SDUCR / L 07	216,00 €	
	E12Q SDUCR / L 07	268,00 €	
	E16R SDUCR / L 11	321,00 €	
	^{NEW} E20S SDUCR / L 11	612,00 €	
S-SYSTEM BORING BARS SETS / BOHRSTANGEN-SET S-SYSTEM			PRICE / PREIS
 <p>SET-A/SCLCR / L CC.T 0602.. CC.T 09T3..</p> <p>95°</p>	A08H SCLCR / L 06	168,00 €	
	A10H SCLCR / L 06		
	A12H SCLCR / L 06		
	A16M SCLCR / L 09		
 <p>SET-E/SCLCR / L CC.T 0602.. CC.T 09T3..</p> <p>95°</p>	E08K SCLCR / L 06	998,00 €	
	E10M SCLCR / L 06		
	E12Q SCLCR / L 06		
	E16R SCLCR / L 09		
 <p>SET-S/SCLCR / L CC.T 0602.. CC.T 09T3..</p> <p>95°</p>	S08H SCLCR / L 06	144,00 €	
	S10K SCLCR / L 06		
	S12K SCLCR / L 06		
	S16P SCLCR / L 09		
 <p>SET-A/SDUCR / L DC.T 0702.. DC.T 11T3..</p> <p>93°</p>	A10H SDUCR / L 07	140,00 €	
	A12H SDUCR / L 07		
	A16M SDUCR / L 11		
 <p>SET-E/SDUCR / L DC.T 0702.. DC.T 11T3..</p> <p>93°</p>	E10M SDUCR / L 07	836,00 €	
	E12Q SDUCR / L 07		
	E16R SDUCR / L 11		
 <p>SET-S/SDUCR / L DC.T 0702.. DC.T 11T3..</p> <p>93°</p>	S10K SDUCR / L 07	119,00 €	
	S12K SDUCR / L 07		
	S16P SDUCR / L 11		

CARTRIDGE / KURZDREHHALTER			PRICE / PREIS		
 <p>90°</p>	SCACR / L CC.T 0602.. CC.T 09T3.. CC.T 1204..	S10X SCACR / L 06 S10A SCACR / L 06 NEW S1018 SCACR / L 06 NEW S1065 SCACR / L 06 S10C SCACR / L 06 S12B SCACR / L 06 S12D SCACR / L 06 S12D SCACR / L 09 NEW S1265 SCACR / L 09 S12H SCACR / L 09 S15C SCACR / L 09 S15E SCACR / L 09 S15D SCACR / L 09 S16A SCACR / L 09 S16B SCACR / L 09 S16C SCACR / L 09 S16D SCACR / L 09 S16E SCACR / L 09 S16G SCACR / L 09 S16H SCACR / L 09 S18E SCACR / L 09 S20E SCACR / L 09 S20E SCACR / L 12 S20H SCACR / L 12	35,00 € 35,00 € 35,00 € 35,00 € 35,00 € 37,00 € 43,00 € 43,00 € 43,00 € 43,00 € 43,00 € 43,00 € 43,00 € 43,00 € 43,00 € 43,00 € 43,00 € 43,00 € 43,00 € 43,00 € 46,00 € 46,00 € 46,00 €		
	SCMCN CC.T 0602.. CC.T 09T3..	S10X SCMCN 06 S16C SCMCN 09 S16D SCMCN 09	35,00 € 43,00 € 43,00 €		
	 <p>-°</p>	STXCR / L TC.T 16T3..	STXCR / L 2020 B16 STXCR / L 2020 E16 STXCR / L 2020 B16-SA STXCR / L 2020 E16-SA STXCR / L 2020 B16-PL STXCR / L 2020 E16-PL STXCR / L 2020 H16-PL	57,00 € 57,00 € 57,00 € 57,00 € 57,00 € 57,00 € 57,00 €	
		CTFPR / L TP.. 16 TP.. 22	CTFPR / L 13CS 16 CTFPR / L 15CS 22	64,00 € 64,00 €	
		 <p>45°</p>	CTSPR / L TP.. 11	CTSPR / L 11.5CS 11	64,00 €

CARTRIDGE / KURZDREHHALTER			PRICE / PREIS
 <p>MSYNR / L SNM. 1204..</p> <p>95°</p>	MSYNR / L 11.5CS 12	64,00 €	
	MSYNR / L 16CS 12	64,00 €	
 <p>SCFCR / L CC.T 0602.. CC.T 09T3.. CC.T 1204..</p> <p>90°</p>	SCFCR / L 06CA 06	45,00 €	
	SCFCR / L 08CA 06	45,00 €	
	SCFCR / L 10CA 09	45,00 €	
	SCFCR / L 12CA 12	45,00 €	
	SCFCR / L 16CA 12	50,00 €	
 <p>SCSCR / L CC.T 0602.. CC.T 09T3.. CC.T 1204..</p> <p>45°</p>	SCSCR / L 06CA 06	45,00 €	
	SCSCR / L 10CA 09	45,00 €	
	SCSCR / L 12CA 12	45,00 €	
 <p>SSKCR / L SC.T 09T3..</p> <p>75°</p>	SSKCR / L 10CA 09	45,00 €	
 <p>STFCR / L TC.T 0902.. TC.T 1102.. TC.T 16T3..</p> <p>90°</p>	STFCR / L 08CA 09	45,00 €	
	STFCR / L 10CA 11	45,00 €	
	STFCR / L 12CA 16	45,00 €	
	STFCR / L 16CA 16	50,00 €	
 <p>STSCR / L TC.T 0902.. TC.T 1102.. TC.T 16T3..</p> <p>45°</p>	STSCR / L 08CA 09	45,00 €	
	STSCR / L 10CA 11	45,00 €	
	STSCR / L 12CA 16	45,00 €	
 <p>STTCR / L TC.T 0902.. TC.T 1102..</p> <p>60°</p>	STTCR / L 08CA 09	45,00 €	
	STTCR / L 10CA 11	45,00 €	



CARTRIDGE / KURZDREHHALTER			PRICE / PREIS	
 <p>75°</p>	PSKNR / L <hr/> SNM. 1204..	PSKNR / L 16CA 12	71,00 €	
 <p>75°</p>	PSRNR / L <hr/> SNM. 1204..	PSRNR / L 16CA 12	71,00 €	
 <p>90°</p>	PTFNR / L <hr/> TNM. 1604..	PTFNR / L 12CA 16	68,00 €	
		NEW PTFNR / L 16CA 16	71,00 €	
 <p>45°</p>	PSDNN 12 <hr/> SNM. 1204..	S22D PSDNN 12C	112,00 €	
PIPE BEVELING AND CHAMFERING TOOLS / ROHRENDENANFASWERKZEUG			PRICE / PREIS	
	ACPBT <hr/>	ACPBT-1	470,00 €	
		ACPBT-2	470,00 €	
		ACPBT-3	470,00 €	
		ACPBT-4	470,00 €	
		ACPBT-5	470,00 €	
		ACPBT-6	470,00 €	
		ACPBT-7	470,00 €	
		ACPBT-8	470,00 €	
	ACPBT <hr/>	ACPBT-9	470,00 €	
		ACPBT-10	470,00 €	



PIPE BEVELING AND CHAMFERING TOOLS BODY / TRÄGER ROHRENDENANFASWERKZEUG		PRICE / PREIS	
	ÖTG	ÖTG-K-120-20	280,00 €
PIPE BEVELING AND CHAMFERING TOOLS CARTRIDGE / KASSETTE FÜR ROHRENDENANFASWERKZEUG		PRICE / PREIS	
	ÖTG-TC..	ÖTG-TC11-4IL	69,00 €
		ÖTG-TC11-4IR	69,00 €
	TC.T 1102..	ÖTG-TC16-1AL	69,00 €
	TC.T 16T3..	ÖTG-TC16-1AR	69,00 €
		ÖTG-TC16-2DL	69,00 €
		ÖTG-TC16-2DR	69,00 €
		ÖTG-TC16-3IL	69,00 €
		ÖTG-TC16-3IR	69,00 €
EXTERNAL THREADING TOOLHOLDERS / GEWINDE-DREHHALTER FÜR AUSSEN		CUTTING INSERT WENDE PLATTE	PRICE / PREIS
	SER / L 0808 E11		36,00 €
	SER / L 1010 E11	11 ER / L	36,00 €
	SER / L 1212 F11		37,00 €
	SER / L 1616 H11		37,00 €
	SER / L 1616 H16C	16 ER / L	41,00 €
	SER / L 2020 K16C	(0.35-3)	43,00 €
	SER / L 2525 M16C	ISO METRIC	46,00 €
	SER / L 3232 P16C		54,00 €
	SER / L 2525 M22C	22 ER / L	51,00 €
	SER / L 3232 P22C	(3.5-4.5)	59,00 €
	SER / L 4040 S22C	ISO METRIC	89,00 €
	SER / L 2525 M16C-T	16 ER / L (1.5-3) TR	46,00 €
	SER / L 2525 M22C-T	22 ER / L (4-6) TR	51,00 €
	SER / L 2020 K16C-S	SNDVK 166	55,00 €
	SER / L 2525 M16C-S	ER / L 16	58,00 €
	SER / L 3232 P16C-S		67,00 €
EXTERNAL THREADING TOOLHOLDERS FOR SWISS TYPE SLIDING AUTOMATIC LATHES AUSSEN-GEWINDEDREHHALTER FÜR LANGDREHAUTOMATEN		CUTTING INSERT WENDE PLATTE	PRICE / PREIS
	SER / L 1010 K11-S		41,00 €
	SER / L 1212 K11-S	11 ER / EL	42,00 €



INTERNAL THREADING TOOLHOLDERS / GEWINDE-DREHHALTER FÜR INNEN		CUTTING INSERT WENDE PLATTE	PRICE / PREIS
	SIR / L S12X05H 06	06 IR / L	51,00 €
	SIR / L S16X07M 08	08 IR / L	36,00 €
	SIR / L S10H 11		36,00 €
	SIR / L S12K 11	11 IR / L	36,00 €
	SIR / L S16X10M 11	ISO	36,00 €
	SIR / L S16X13M 11		36,00 €
	SIR / L S16M 11		36,00 €
	SIR / L S16x13M 16		36,00 €
	SIR / L S16M 16		36,00 €
	SIR / L S20x16P 16	16 IR / L	38,00 €
	SIR / L S20P 16	(0.35-3)	38,00 €
	SIR / L S25R 16C	ISO METRIC	48,00 €
	SIR / L S32S 16C		63,00 €
	SIR / L S40T 16C		81,00 €
	SIR / L S50U 16C		112,00 €
	SIR / L S20P 22		38,00 €
	SIR / L S25R 22C	22 IR / L	51,00 €
	SIR / L S32S 22C	(3.5-4.5)	68,00 €
	SIR / L S40T 22C	ISO METRIC	81,00 €
	SIR / L S50U 22C		112,00 €
SIR / L S25R 16C-T	16 IR / L (2-3) TR	48,00 €	
SIR / L S32S 16C-T	ISO	63,00 €	
SIR / L S25R 22C-T	22 IR / L (4-6) TR	51,00 €	
SIR / L S32S 22C-T	ISO	68,00 €	



EXTERNAL THREADING TOOLHOLDERS / GEWINDE-DREHHALTER FÜR AUSSEN		CUTTING INSERT WENDE PLATTE	PRICE / PREIS
	TER / L 1616 H16		46,00 €
	TER / L 2020 K16	16 ER / L	48,00 €
	TER / L 2525 M16	ISO	51,00 €
	TER / L 3232 P16		59,00 €
	TER / L 2525 M22	22 ER / L	59,00 €
	TER / L 3232 P22	ISO	67,00 €
	TER / L 4040 S22		97,00 €
	TER / L 2525 M27	27 ER / L	98,00 €
	TER / L 3232 P27	ISO	107,00 €
	TER / L 4040 S27		142,00 €

INTERNAL THREADING TOOLHOLDERS / GEWINDE-DREHHALTER FÜR INNEN		CUTTING INSERT WENDE PLATTE	PRICE / PREIS
	TIR / L S25R 16		53,00 €
	TIR / L S32S 16	16 IR / L	68,00 €
	TIR / L S40T 16	ISO	86,00 €
	TIR / L S50U 16		117,00 €
	TIR / L S25R 22		59,00 €
	TIR / L S32S 22	22 IR / L	77,00 €
	TIR / L S40T 22	ISO	89,00 €
	TIR / L S50U 22		120,00 €
	TIR / L S32S 27	27 IR / L	116,00 €
	TIR / L S40T 27	ISO	129,00 €
	TIR / L S50U 27		151,00 €





EXTERNAL GROOVING TOOLHOLDERS / AUßEN - STECHHALTER		CUTTING INSERT WENDE PLATTE	PRICE / PREIS
 <p>COMPATIBLE WITH KRLY-JD INSERT KOMPATIBEL FÜR WENDESCHNEIDPLATTEN KRLY-JD</p>	ADKT-K-R/L-1212-2-T15	MGM. - 2	70,00 €
	ADKT-K-R/L-1616-2-T15	MGM. - 2	71,00 €
	ADKT-K-R/L-2020-2-T15	MGM. - 2	72,00 €
	ADKT-K-R/L-2525-2-T15	MGM. - 2	73,00 €
	ADKT-K-R/L-3232-2-T15	MGM. - 2	85,00 €
	ADKT-K-R/L-1212-3-T15	MGM. - 3	70,00 €
	ADKT-K-R/L-1616-3-T15	MGM. - 3	71,00 €
	ADKT-K-R/L-2020-3-T20	MGM. - 3	72,00 €
	ADKT-K-R/L-2020-3-R28	MGM. - 3	94,00 €
	ADKT-K-R/L-2525-3-R15	MGM. - 3	73,00 €
	ADKT-K-R/L-2525-3-T22	MGM. - 3	73,00 €
	ADKT-K-R/L-3232-3-T22	MGM. - 3	85,00 €
	ADKT-K-R/L-2020-4-T20	MGM. - 4	72,00 €
	ADKT-K-R/L-2020-4-R25	MGM. - 4	87,00 €
	ADKT-K-R/L-2525-4-T18	MGM. -4	73,00 €
	ADKT-K-R/L-2525-4-T22	MGM. -4	73,00 €
	ADKT-K-R/L-3232-4-T22	MGM. -4	85,00 €
	ADKT-K-R/L-2020-5-T20	MGM. -5	72,00 €
	ADKT-K-R/L-2525-5-T18	MGM. -5	73,00 €
	ADKT-K-R/L-2525-5-T25	MGM. -5	73,00 €
ADKT-K-R/L-3232-5-T25	MGM. -5	85,00 €	
ADKT-K-R/L-2525-6-T25	MGM. -6	73,00 €	
ADKT-K-R/L-3232-6-T25	MGM. -6	85,00 €	
ADKT-K-R/L-3232-8-T32	MGM. -8	112,00 €	
 <p>COMPATIBLE WITH KRLY INSERT KOMPATIBEL FÜR WENDESCHNEIDPLATTEN KRLY</p>	ADKT-KG-R/L-2020-2-T15	KG.. - 2	93,00 €
	ADKT-KG-R/L-2525-2-T15	KG.. - 2	94,00 €
	ADKT-KG-R/L-2525-2-T17	KG.. - 2	94,00 €
	ADKT-KG-R/L-1616-3-T20	KG.. - 3	92,00 €
	ADKT-KG-R/L-2020-3-T20	KG.. - 3	93,00 €
	ADKT-KG-R/L-2525-3-T22	KG.. - 3	94,00 €
	ADKT-KG-R/L-2020-4-T20	KG.. - 4	93,00 €
	NEW ADKT-KG-R/L-2525-4-T16	KG.. - 4	94,00 €
ADKT-KG-R/L-2525-4-T22	KG.. - 4	94,00 €	
 <p>COMPATIBLE WITH HRN INSERT KOMPATIBEL FÜR WENDESCHNEIDPLATTEN HRN</p>	ADKT-H-R/L-2020-3-T20	S229 - 3	72,00 €
	ADKT-H-R/L-2525-3-T22	S229 - 3	73,00 €
	NEW ADKT-H-R/L-2525-3-T26	S229 - 3	80,00 €
	ADKT-H-R/L-2020-4-T20	S229 - 4	72,00 €
	ADKT-H-R/L-2525-4-T22	S229 - 4	73,00 €
	ADKT-H-R/L-3232-4-T22	S229 - 4	85,00 €
	ADKT-H-R/L-2020-5-T20	S229 - 5	72,00 €
	ADKT-H-R/L-2525-5-T25	S229 - 5	73,00 €
	ADKT-H-R/L-2525-6-T25	S229 - 6	73,00 €



EXTERNAL GROOVING TOOLHOLDERS / AUßEN - STECHHALTER		CUTTING INSERT WENDE PLATTE	PRICE / PREIS
 <p>COMPATIBLE WITH HRN INSERT KOMPATIBEL FÜR WENDESCHNEIDPLATTEN HRN</p>	ADKT-HK-R/L-1616-2-T15	S224 - 2	71,00 €
	ADKT-HK-R/L-2020-2-T15	S224 - 2	72,00 €
	ADKT-HK-R/L-2525-2-T15	S224 - 2	73,00 €
	ADKT-HK-R/L-2020-3-T20	S224 - 3	72,00 €
	ADKT-HK-R/L-2525-3-T22	S224 - 3	73,00 €
	ADKT-HK-R/L-2020-4-T20	S224 - 4	72,00 €
	ADKT-HK-R/L-2525-4-T22	S224 - 4	73,00 €
	ADKT-HS223-R/L-2020-2-T15	S223 - 2	72,00 €
NEW ADKT-HS223-R/L-2020-3-T17	S223 - 3	72,00 €	
 <p>COMPATIBLE WITH ZCC INSERT KOMPATIBEL FÜR WENDESCHNEIDPLATTEN ZCC</p>	ADKT-ZCC1-R/L-2020-3-T20	ZQMX - 3	72,00 €
	ADKT-ZCC1-R/L-2525-3-T22	ZQMX - 3	73,00 €
	ADKT-ZCC1-R/L-2020-4-T20	ZQMX - 4	72,00 €
	ADKT-ZCC1-R/L-2525-4-T22	ZQMX - 4	73,00 €
	ADKT-ZCC2-R/L-1616-2-T15	Z.BD - 2	71,00 €
	ADKT-ZCC2-R/L-2020-2-T15	Z.BD - 2	72,00 €
	ADKT-ZCC2-R/L-2525-2-T15	Z.BD - 2	73,00 €
	NEW ADKT-ZCC2-R/L-1616-2.5-T15	Z.ED - 2.5	71,00 €
	NEW ADKT-ZCC2-R/L-2020-2.5-T17	Z.ED - 2.5	72,00 €
	ADKT-ZCC2-R/L-2525-2.5-T15	Z.ED - 2.5	73,00 €
	ADKT-ZCC2-R/L-1616-3-T15	Z.FD - 3	71,00 €
	NEW ADKT-ZCC2-R/L-1616-3-T17	Z.FD - 3	71,00 €
	NEW ADKT-ZCC2-R/L-1616-3-T20	Z.FD - 3	72,00 €
	ADKT-ZCC2-R/L-2020-3-T12	Z.FD - 3	72,00 €
	ADKT-ZCC2-R/L-2020-3-T20	Z.FD - 3	72,00 €
	NEW ADKT-ZCC2-R/L-2020-3-R21	Z.FD - 3	72,00 €
	NEW ADKT-ZCC2-R/L-2020-3-R25	Z.FD - 3	79,00 €
	ADKT-ZCC2-R/L-2525-3-T12	Z.FD - 3	73,00 €
	ADKT-ZCC2-R/L-2525-3-T22	Z.FD - 3	73,00 €
	ADKT-ZCC2-R/L-2525-3-R30	Z.FD - 3	88,00 €
	ADKT-ZCC2-R/L-2020-4-T12	Z.GD - 4	72,00 €
	ADKT-ZCC2-R/L-2020-4-T20	Z.GD - 4	72,00 €
	ADKT-ZCC2-R/L-2525-4-T12	Z.GD - 4	73,00 €
	ADKT-ZCC2-R/L-2525-4-T22	Z.GD - 4	73,00 €
	ADKT-ZCC2-R/L-2020-5-T12	Z.HD - 5	72,00 €
	ADKT-ZCC2-R/L-2020-5-T20	Z.HD - 5	72,00 €
	ADKT-ZCC2-R/L-2525-5-T12	Z.HD - 5	73,00 €
	ADKT-ZCC2-R/L-2525-5-T25	Z.HD - 5	73,00 €
	NEW ADKT-ZCC2-R/L-3232-5-T25	Z.HD - 5	85,00 €
	ADKT-ZCC2-R/L-2020-6-T20	Z.KD - 6	72,00 €
ADKT-ZCC2-R/L-2525-6-T25	Z.KD - 6	73,00 €	
ADKT-ZCC2-R/L-3232-6-T25	Z.KD - 6	85,00 €	
ADKT-ZCC2-R/L-3232-6-T30	Z.KD - 6	123,00 €	

EXTERNAL GROOVING TOOLHOLDERS / AUßEN - STECHHALTER	CUTTING INSERT WENDE PLATTE	PRICE / PREIS	
 <p>COMPATIBLE WITH KNMTL INSERT KOMPATIBEL FÜR WENDESCHNEIDPLATTEN KNMTL</p>	ADKT-KM-R/L-2020-2-T15	A4. - 2	72,00 €
	ADKT-KM-R/L-2525-2-T15	A4. - 2	73,00 €
	ADKT-KM-R/L-2020-3-T20	A4. - 3	72,00 €
	ADKT-KM-R/L-2525-3-T22	A4. - 3	73,00 €
	ADKT-KM-R/L-2525-4-T22	A4. - 4	73,00 €
 <p>COMPATIBLE WITH TGTC INSERT KOMPATIBEL FÜR WENDESCHNEIDPLATTEN TGTC</p>	ADKT-TD-R/L-1212-2-T15	TD. - 2	91,00 €
	ADKT-TD-R/L-1616-2-T15	TD. - 2	92,00 €
	NEW ADKT-TD-R/L-2020-2-T9	TD. - 2	93,00 €
	ADKT-TD-R/L-2020-2-T15	TD. - 2	93,00 €
	NEW ADKT-TD-R/L-2020-2-T20	TD. - 2	93,00 €
	ADKT-TD-R/L-2525-2-T17	TD. - 2	94,00 €
	ADKT-TD-R/L-1212-3-T15	TD. - 3	91,00 €
	ADKT-TD-R/L-1616-3-T15	TD. - 3	92,00 €
	ADKT-TD-R/L-2020-3-T20	TD. - 3	93,00 €
	NEW ADKT-TD-R/L-2020-3-T30	TD. - 3	100,00 €
	ADKT-TD-R/L-2525-3-T9	TD. - 3	94,00 €
	ADKT-TD-R/L-2525-3-T22	TD. - 3	94,00 €
	NEW ADKT-TD-R/L-2525-3-T25	TD. - 3	97,00 €
	NEW ADKT-TD-R/L-2525-3-T30	TD. - 3	101,00 €
	ADKT-TD-R/L-2525-4-T22	TD. - 4	94,00 €
	NEW ADKT-TD-R/L-2525-4-T30	TD. - 4	101,00 €
ADKT-TD-R/L-2525-5-T25	TD. - 5	94,00 €	
 <p>COMPATIBLE WITH ISCR INSERT KOMPATIBEL FÜR WENDESCHNEIDPLATTEN ISCR</p>	ADKT-ITG-R/L-2020-3-T8	TGM. - 3	89,00 €
	ADKT-ITG-R/L-2525-3-T8	TGM. - 3	90,00 €
	ADKT-ITG-R/L-3232-3-T8	TGM. - 3	105,00 €
	ADKT-ITG-R/L-2020-4-T9	TGM. - 4	89,00 €
	ADKT-ITG-R/L-2525-4-T17	TGM. - 4	90,00 €
	ADKT-ITG-R/L-3232-4-T17	TGM. - 4	105,00 €
	ADKT-ITG-R/L-3232-5-T25	TGM. - 5	105,00 €

EXTERNAL GROOVING TOOLHOLDERS / AUßEN - STECHHALTER		CUTTING INSERT WENDE PLATTE	PRICE / PREIS
 <p>COMPATIBLE WITH ISCR INSERT KOMPATIBEL FÜR WENDESCHNEIDPLATTEN ISCR</p>	ADKT-I-R/L-1212-2-T15	DGN - 2	70,00 €
	ADKT-I-R/L-1616-2-T15	DGN - 2	71,00 €
	ADKT-I-R/L-2020-2-T15	DGN - 2	72,00 €
	ADKT-I-R/L-2525-2-T15	DGN - 2	73,00 €
	ADKT-I-R/L-3232-2-T15	DGN - 2	85,00 €
	ADKT-I-R/L-1212-3-T15	DGN - 3	70,00 €
	ADKT-I-R/L-1616-3-T15	DGN - 3	71,00 €
	ADKT-I-R/L-2020-3-T20	DGN - 3	72,00 €
	ADKT-I-R/L-2525-3-T22	DGN - 3	73,00 €
	ADKT-I-R/L-3232-3-T22	DGN - 3	85,00 €
	ADKT-I-R/L-2020-4-T20	DGN / GRP - 4	72,00 €
	ADKT-I-R/L-2525-4-T22	DGN / GRP - 4	73,00 €
	ADKT-I-R/L-2525-4-T25	DGN / GRP - 4	73,00 €
	ADKT-I-R/L-3232-4-T25	DGN / GRP - 4	85,00 €
	ADKT-I-R/L-2020-5-T20	DGN / GRP - 5	72,00 €
	ADKT-I-R/L-2525-5-T25	DGN / GRP - 5	73,00 €
	NEW ADKT-IG-R/L-1616-3-T18	GRP - 3	71,00 €
	ADKT-IG-R/L-2020-3-R20	GRP - 3	72,00 €
	ADKT-IG-R/L-2525-3-T22	GRP - 3	73,00 €
	ADKT-IGI-R/L-2020-2-T15	GIM / GIP - 2	72,00 €
	ADKT-IGI-R/L-2525-2-T15	GIM / GIP - 2	73,00 €
	ADKT-IGI-R/L-1616-3-T15	GIM / GIP - 3	71,00 €
	ADKT-IGI-R/L-2020-3-T20	GIM / GIP - 3	72,00 €
	ADKT-IGI-R/L-2525-3-T22	GIM / GIP - 3	73,00 €
ADKT-IGI-R/L-2525-4-T22	GIM / GIP - 4	73,00 €	
ADKT-IGI-R/L-2525-5-T25	GIM / GIP - 5	73,00 €	
ADKT-IGI-R/L-2525-8-T30	GIM / GIP - 8	112,00 €	
ADKT-IGTN-R/L-2525-5-T25	GTN - 5	73,00 €	
ADKT-IDC-R/L-2525-3-T21	DCE - 3	73,00 €	
 <p>COMPATIBLE WITH SNDVK INSERT KOMPATIBEL FÜR WENDESCHNEIDPLATTEN SNDVK</p>	ADKT-123-R/L-1212-1.5-R15	123 - 1.5	70,00 €
	ADKT-123-R/L-1616-1.5-R15	123 - 1.5	71,00 €
	ADKT-123-R/L-1616-2-T15	123 - 2	71,00 €
	ADKT-123-R/L-2020-2-T8	123 - 2	72,00 €
	ADKT-123-R/L-2020-2-T15	123 - 2	72,00 €
	ADKT-123-R/L-2525-2-T15	123 - 2	73,00 €
	ADKT-123-R/L-3232-2-T15	123 - 2	105,00 €
	ADKT-123-R/L-1616-3-T15	123 - 3	71,00 €
	ADKT-123-R/L-2020-3-T20	123 - 3	72,00 €
	ADKT-123-R/L-2525-3-T22	123 - 3	73,00 €
	ADKT-123-R/L-2020-4-T20	123 - 4	72,00 €
	ADKT-123-R/L-2525-4-T22	123 - 4	73,00 €
	ADKT-123-R/L-3232-4-T25	123 - 4	105,00 €
	ADKT-123-R/L-2020-5-T20	123 - 5	72,00 €
	ADKT-123-R/L-2525-5-T25	123 - 5	73,00 €
	ADKT-123-R/L-3232-6-T15	123 - 6	105,00 €

EXTERNAL GROOVING TOOLHOLDERS / AUßEN - STECHHALTER		CUTTING INSERT WENDE PLATTE	PRICE / PREIS
 <p>COMPATIBLE WITH SNDVK INSERT KOMPATIBEL FÜR WENDESCHNEIDPLATTEN SNDVK</p>	ADKT-151.22-R/L-1616-2-T15	151.2 - 2	71,00 €
	ADKT-151.22-R/L-2020-2-T15	151.2 - 2	72,00 €
	ADKT-151.22-R/L-2525-2-T15	151.2 - 2	73,00 €
	ADKT-151.22-R/L-1616-3-T15	151.2 - 3	71,00 €
	ADKT-151.22-R/L-2020-3-T20	151.2 - 3	72,00 €
	ADKT-151.22-R/L-2525-3-T22	151.2 - 3	73,00 €
	ADKT-151.22-R/L-1616-4-T15	151.2 - 4	71,00 €
	ADKT-151.22-R/L-2020-4-T20	151.2 - 4	72,00 €
	ADKT-151.22-R/L-2525-4-T22	151.2 - 4	73,00 €
	ADKT-151.22-R/L-2020-5-T20	151.2 - 5	72,00 €
	ADKT-151.22-R/L-2525-5-T25	151.2 - 5	73,00 €
 <p>COMPATIBLE WITH SNDVK INSERT KOMPATIBEL FÜR WENDESCHNEIDPLATTEN SNDVK</p>	ADKT-151.23-R/L-1616-2-T15	151.2 - 2	71,00 €
	ADKT-151.23-R/L-2020-2-T15	151.2 - 2	72,00 €
	ADKT-151.23-R/L-2525-2-T15	151.2 - 2	73,00 €
	ADKT-151.23-R/L-1616-2.5-T15	151.2 - 2.5	71,00 €
	ADKT-151.23-R/L-2020-2.5-T15	151.2 - 2.5	72,00 €
	ADKT-151.23-R/L-2525-2.5-T15	151.2 - 2.5	73,00 €
	ADKT-151.23-R/L-1212-3-T15	151.2 - 3	70,00 €
	ADKT-151.23-R/L-1616-3-T15	151.2 - 3	71,00 €
	ADKT-151.23-R/L-2020-3-T20	151.2 - 3	72,00 €
	ADKT-151.23-R/L-2525-3-T20	151.2 - 3	73,00 €
	ADKT-151.23-R/L-2525-3-T22	151.2 - 3	73,00 €
	ADKT-151.23-R/L-1616-4-T15	151.2 - 4	71,00 €
	ADKT-151.23-R/L-2020-4-T20	151.2 - 4	72,00 €
	ADKT-151.23-R/L-2525-4-T22	151.2 - 4	73,00 €
	ADKT-151.23-R/L-2020-5-T20	151.2 - 5	72,00 €
ADKT-151.23-R/L-2525-5-T25	151.2 - 5	73,00 €	
 <p>COMPATIBLE WITH SNDVK INSERT KOMPATIBEL FÜR WENDESCHNEIDPLATTEN SNDVK</p>	ADKT-154-91-R/L-2020-3-T4	154.91 - 3	72,00 €
	ADKT-154-91-R/L 2525-3-T4	154.91 - 3	73,00 €
	ADKT-154-91-R/L 2020-5-T5	154.91 - 5	72,00 €
	ADKT-154-91-R/L 2525-5-T5	154.91 - 5	73,00 €
 <p>COMPATIBLE WITH ARN INSERT KOMPATIBEL FÜR WENDESCHNEIDPLATTEN ARN</p>	ADKT-ARN-R/L-2020-2-T15	LOMR. - 2	72,00 €
	ADKT-ARN-R/L-2525-2-T15	LOMR. - 2	73,00 €
	ADKT-ARN-R/L-2020-3-T20	LOMR. - 3	72,00 €
	ADKT-ARN-R/L-2525-3-T22	LOMR. - 3	73,00 €





EXTERNAL GROOVING TOOLHOLDERS / AUßEN - STECHHALTER		CUTTING INSERT WENDE PLATTE	PRICE / PREIS
 <p>COMPATIBLE WITH SMTM INSERT KOMPATIBEL FÜR WENDESCHNEIDPLATTEN SMTM</p>	ADKT-SWC-R/L-2020-2-T25	WCF. - 2	102,00 €
	ADKT-SWC-R/L-2020-3-T25	WCF. - 3	102,00 €
 <p>COMPATIBLE WITH SMTM INSERT KOMPATIBEL FÜR WENDESCHNEIDPLATTEN SMTM</p>	ADKT-SGC-R/L-1212-2-R15	GCM N20	91,00 €
	ADKT-SGC-R/L-1616-2-R15	GCM N20	92,00 €
	ADKT-SGC-R/L-2020-2-R20	GCM N20	93,00 €
	ADKT-SGC-R/L-2525-2-R20	GCM N20	94,00 €
	ADKT-SGC-R/L-1212-3-R15	GCM N30	91,00 €
	ADKT-SGC-R/L-1616-3-R15	GCM N30	92,00 €
	ADKT-SGC-R/L-2020-3-R22	GCM N30	93,00 €
	ADKT-SGC-R/L-2525-3-R15	GCM N30	94,00 €
	ADKT-SGC-R/L-2525-3-R22	GCM N30	94,00 €
	ADKT-SGC-R/L-2525-4-R25	GCM N40	94,00 €
 <p>COMPATIBLE WITH HRN INSERT KOMPATIBEL FÜR WENDESCHNEIDPLATTEN HRN</p>	ADKT-H22-R/L-1616-(0.5-2)-T6	S312 - (0.5-2)	71,00 €
	ADKT-H22-R/L-2020-(0.5-2)-T6	S312 - (0.5-2)	72,00 €
	ADKT-H22-R/L-2525-(0.5-2)-T6	S312 - (0.5-2)	73,00 €
 <p>COMPATIBLE WITH LMNA INSERT KOMPATIBEL FÜR WENDESCHNEIDPLATTEN LMNA</p>	ADKT-LGC-R/L-1616-2-D40	GCTX - 2	92,00 €
	ADKT-LGC-R/L-2020-2-D40	GCTX - 2	93,00 €
	ADKT-LGC-R/L-2525-2-D40	GCTX - 2	94,00 €
	ADKT-LGC-R/L-1616-3-T20	GCTX - 3	92,00 €
	ADKT-LGC-R/L-2020-3-T20	GCTX - 3	93,00 €
	ADKT-LGC-R/L-2525-3-T20	GCTX - 3	94,00 €
 <p>COMPATIBLE WITH WLTR INSERT KOMPATIBEL FÜR WENDESCHNEIDPLATTEN WLTR</p>	ADKT-WGX16-R/L-2020-2-R16	GX16. - 2	93,00 €
	NEW ADKT-WGX16-R/L-2525-2-R16	GX16. - 2	94,00 €
	NEW ADKT-WGX24-R/L-2020-3-T20	GX24. - 3	93,00 €
	ADKT-WGX24-R/L-2525-3-T22	GX24. - 3	94,00 €
	NEW ADKT-WGX24-R/L-3232-3-T22	GX24. - 3	108,00 €
	ADKT-WGX24-R/L-2525-4-T22	GX24. - 4	94,00 €
	ADKT-WGX24-R/L-2525-5-T25	GX24. - 5	94,00 €
ADKT-WGX24-R/L-3232-5-T25	GX24. - 5	108,00 €	

EXTERNAL GROOVING TOOLHOLDERS / AUßEN - STECHHALTER		CUTTING INSERT WENDE PLATTE	PRICE / PREIS
 <p>COMPATIBLE WITH PLBT INSERT KOMPATIBEL FÜR WENDESCHNEIDPLATTEN PLBT</p>	ADKT-GP-R/L-2020-2-T15	GP - 2	93,00 €
	ADKT-GP-R/L-2525-2-T15	GP - 2	94,00 €
	ADKT-GP-R/L-2020-3-T20	GP - 3	93,00 €
	ADKT-GP-R/L-2525-3-T22	GP - 3	94,00 €
	ADKT-GP-R/L-2525-4-T22	GP - 4	94,00 €
	ADKT-GP-R/L-2525-5-T25	GP - 5	94,00 €
 <p>COMPATIBLE WITH CRTZT INSERT KOMPATIBEL FÜR WENDESCHNEIDPLATTEN CRTZT</p>	ADKT-CD-R/L-2020-3-R20	GX24 0300	72,00 €
	ADKT-CD-R/L-2525-3-R23	GX24 0300	73,00 €

L TYPE FACE GROOVING TOOLHOLDERS / AXIAL- STECHHALTER L TYPE		CUTTING INSERT WENDE PLATTE	PRICE / PREIS
 <p>COMPATIBLE WITH ZCC INSERT KOMPATIBEL FÜR WENDESCHNEIDPLATTEN ZCC</p>	ALKT-ZCC2-R/L-2525-35-45-3-T10	Z.FD - 3	117,00 €
	ALKT-ZCC2-R/L-2525-39-55-3-T10	Z.FD - 3	117,00 €
	ALKT-ZCC2-R/L-2525-35- \varnothing -3-T4	Z.FD - 3	117,00 €
	ALKT-ZCC2-R/L-2525-40-60-4-T14	Z.GD - 4	117,00 €
	ALKT-ZCC2-R/L-2525-52-80-4-T14	Z.GD - 4	117,00 €
	ALKT-ZCC2-R/L-2525-72-110-4-T14	Z.GD - 4	117,00 €
	ALKT-ZCC2-R/L-2525-100-230-4-T14	Z.GD - 4	117,00 €
	ALKT-ZCC2-R/L-2525-40- \varnothing -4-T4	Z.GD - 4	117,00 €

Ordering Example/Beispiel Bestellformular: 1pcs. ADKT-GP-R-2020-2-T15





EXTERNAL GROOVING TOOLHOLDERS FOR SWISS TYPE SLIDING AUTOMATIC LATHES <i>Werkzeuge zur Stechbearbeitung auf Langdrehautomaten</i>		CUTTING INSERT <i>WENDE PLATTE</i>	PRICE / PREIS
 <p>COMPATIBLE WITH TGTC INSERT KOMPATIBEL FÜR WENDESCHNEIDPLATTEN TGTC</p>	ADKT-TD-R/L-1212-2-T12-K-S	TD. - 2	91,00 €
	ADKT-TD-R/L-1616-2-T16-K-S	TD. - 2	92,00 €
	ADKT-TD-R/L-1212-3-T12-K-S	TD. - 3	91,00 €
	ADKT-TD-R/L-1616-3-T16-K-S	TD. - 3	92,00 €
 <p>COMPATIBLE WITH ZCC INSERT KOMPATIBEL FÜR WENDESCHNEIDPLATTEN ZCC</p>	ADKT-ZCC2-R/L-1010-2-T12-K-S	Z.BD - 2	91,00 €
	ADKT-ZCC2-R/L-1212-2-T12-K-S	Z.BD - 2	91,00 €
	ADKT-ZCC2-R/L-1616-2-R16-K-S	Z.BD - 2	92,00 €
	ADKT-ZCC2-R/L-1212-3-T12-K-S	Z.FD - 2	91,00 €
 <p>COMPATIBLE WITH KRLY INSERT KOMPATIBEL FÜR WENDESCHNEIDPLATTEN KRLY</p>	ADKT-KG-R/L-1212-2-R12-K-S	KG. - 2	100,00 €
	<small>NEW</small> ADKT-KG-R/L-1616-2-R16-K-S	KG. - 2	101,00 €
	ADKT-KG-R/L-1212-3-R12-K-S	KG. - 3	100,00 €
	<small>NEW</small> ADKT-KG-R/L-1616-3-R16-K-S	KG. - 3	101,00 €
 <p>COMPATIBLE WITH ISCR INSERT KOMPATIBEL FÜR WENDESCHNEIDPLATTEN ISCR</p>	ADKT-I-R/L-0808-2-R10-S	DGN - 2	89,00 €
	ADKT-I-R/L-1010-2-R10-K-S	DGN - 2	91,00 €
	ADKT-I-R/L-1212-2-R12-K-S	DGN - 2	91,00 €
	ADKT-I-R/L-1616-3-R16-S	DGN - 3	91,00 €
 <p>COMPATIBLE WITH WLTR INSERT KOMPATIBEL FÜR WENDESCHNEIDPLATTEN WLTR</p>	<small>NEW</small> ADKT-WGX16-R/L-1212-2-R12-K-S	GX16. - 2	91,00 €
	ADKT-WGX16-R/L-1616-2-R16-K-S	GX16. - 2	92,00 €
	ADKT-WGX24-R/L-1616-3-R16-K-S	GX24. - 3	105,00 €

FACE GROOVING TOOLHOLDERS / AXIAL- STECHHALTER		CUTTING INSERT WENDE PLATTE	PRICE / PREIS
 <p>COMPATIBLE WITH KRLY INSERT KOMPATIBEL FÜR WENDESCHNEIDPLATTEN KRLY</p>	AAKT-K-R/L-2525-34-45-3-T17	MGM. - 3	112,00 €
	AAKT-K-R/L-2525-39-55-3-T17	MGM. - 3	112,00 €
	AAKT-K-R/L-2525-49-80-3-T17	MGM. - 3	112,00 €
	AAKT-K-R/L-2525-70-110-3-T17	MGM. - 3	112,00 €
	AAKT-K-R/L-2525-100-150-3-T17	MGM. - 3	112,00 €
	AAKT-K-R/L-2525-80-180-3-T32	MGM. - 3	117,00 €
	AAKT-K-R/L-2525-175-215-3-T22	MGM. - 3	112,00 €
	NEW AAKT-K-R/L-2525-700-800-3-T17	MGM. - 3	112,00 €
	AAKT-K-R/L-2525-50-85-4-T22	MGM. - 4	112,00 €
	AAKT-K-R/L-2525-70-110-4-T22	MGM. - 4	112,00 €
	AAKT-K-R/L-2525-100-150-4-T22	MGM. - 4	112,00 €
	AAKT-K-R/L-2525-80-180-4-T32	MGM. - 4	117,00 €
	AAKT-K-R/L-2525-180-800-4-T32	MGM. - 4	117,00 €
	AAKT-K-R/L-2525-70-110-5-T25	MGM. - 5	112,00 €
	AAKT-K-R/L-2525-100-150-5-T25	MGM. - 5	112,00 €
	AAKT-K-R/L-2525-140-200-5-T25	MGM. - 5	112,00 €
	AAKT-K-R/L-2525-80-180-5-T32	MGM. - 5	117,00 €
	AAKT-K-R/L-2525-180-800-5-T32	MGM. - 5	117,00 €
	AAKT-K-R/L-2525-60-100-6-T25	MGM. - 6	112,00 €
	AAKT-K-R/L-2525-60-100-6-T35	MGM. - 6	122,00 €
	AAKT-K-R/L-2525-100-200-6-T25	MGM. - 6	112,00 €
	AAKT-K-R/L-2525-100-200-6-T35	MGM. - 6	122,00 €
	AAKT-K-R/L-2525-140-300-6-T35	MGM. - 6	122,00 €
	AAKT-K-R/L-2525-140-300-8-T35	MGM. - 8	128,00 €
	AAKT-K-R/L-3232-140-350-8-T35	MGM. - 8	138,00 €

FACE GROOVING TOOLHOLDERS / AXIAL- STECHHALTER		CUTTING INSERT WENDE PLATTE	PRICE / PREIS
 <p>COMPATIBLE WITH ZCC INSERT KOMPATIBEL FÜR WENDESCHNEIDPLATTEN ZCC</p>	AAKT-ZCC2-R/L-2525-140-180-2-T4	Z.BD - 2	112,00 €
	AAKT-ZCC2-R/L-2525-35-45-3-T17	Z.FD - 3	112,00 €
	AAKT-ZCC2-R/L-2525-39-55-3-T17	Z.FD - 3	112,00 €
	AAKT-ZCC2-R/L-2525-49-80-3-T17	Z.FD - 3	112,00 €
	AAKT-ZCC2-R/L-2525-70-110-3-T17	Z.FD - 3	112,00 €
	AAKT-ZCC2-R/L-2525-100-150-3-T17	Z.FD - 3	112,00 €
	AAKT-ZCC2-R/L-2525-40-60-4-T22	Z.GD - 4	112,00 €
	AAKT-ZCC2-R/L-2525-52-80-4-T22	Z.GD - 4	112,00 €
	AAKT-ZCC2-R/L-2525-72-110-4-T22	Z.GD - 4	112,00 €
	AAKT-ZCC2-R/L-2525-100-150-4-T22	Z.GD - 4	112,00 €
	AAKT-ZCC2-R/L-2525-140-200-4-T22	Z.GD - 4	112,00 €
	AAKT-ZCC2-R/L-2525-55-95-5-T25	Z.HD - 5	112,00 €
	AAKT-ZCC2-R/L-2525-85-140-5-T25	Z.HD - 5	112,00 €
	AAKT-ZCC2-R/L-2525-130-200-5-T25	Z.HD - 5	112,00 €
	AAKT-ZCC2-R/L-2525-190-400-5-T25	Z.HD - 5	112,00 €
	AAKT-ZCC2-R/L-2525-190-400-5-T35	Z.HD - 5	133,00 €
	AAKT-ZCC2-R/L-2525-200-500-5-T17	Z.HD - 5	112,00 €
	AAKT-ZCC2-R/L-2525-60-110-6-T15	Z.KD - 6	112,00 €

FACE GROOVING TOOLHOLDERS / AXIAL- STECHHALTER		CUTTING INSERT WENDE PLATTE	PRICE / PREIS
 <p>COMPATIBLE WITH ISCR INSERT KOMPATIBEL FÜR WENDESCHNEIDPLATTEN ISCR</p>	AAKT-IG-R/L-2525-40-60-4-T25	DGN / GRP - 4	129,00 €
	AAKT-IG-R/L-2525-52-80-4-T25	DGN / GRP - 4	129,00 €
	AAKT-IG-R/L-2525-70-110-4-T28	DGN / GRP - 4	129,00 €
	AAKT-IG-R/L-2525-110-200-4-T28	DGN / GRP - 4	129,00 €
	AAKT-IG-R/L-2525-110-200-4-T32	DGN / GRP - 4	129,00 €
	AAKT-IG-R/L-2525-180-800-4-T28	DGN / GRP - 4	129,00 €
	AAKT-IG-R/L-2525-70-110-5-T32	DGN / GRP - 5	129,00 €
	AAKT-IG-R/L-2525-110-200-5-T32	DGN / GRP - 5	129,00 €
	AAKT-IG-R/L-2525-180-800-5-T32	DGN / GRP - 5	129,00 €
	AAKT-IG-R/L-2525-58-100-6-T32	DGN / GRP - 6	129,00 €
AAKT-IG-R/L-2525-88-180-6-T32	DGN / GRP - 6	129,00 €	

BLADES FOR PARTING AND DEEP GROOVING / Stechschwert zur Außenbearbeitung		CUTTING INSERT WENDE PLATTE	PRICE / PREIS
 <p>COMPATIBLE WITH ISCR INSERT KOMPATIBEL FÜR WENDESCHNEIDPLATTEN ISCR</p>	AKL-I-26-2	DGN - 2	100,00 €
	AKL-I-32-2	DGN - 2	106,00 €
	AKL-I-26-3	DGN - 3	100,00 €
	AKL-I-32-3	DGN - 3	106,00 €
	AKL-I-26-4	DGN / GRP - 4	100,00 €
	AKL-I-32-4	DGN / GRP - 4	106,00 €

 <p>COMPATIBLE WITH SNDVK INSERT KOMPATIBEL FÜR WENDESCHNEIDPLATTEN SNDVK</p>	AKL-123-32-2	123 - 2	106,00 €
	AKL-123-32-3	123 - 3	106,00 €
	AKL-123-32-4	123 - 4	106,00 €

 <p>COMPATIBLE WITH TGTC INSERT KOMPATIBEL FÜR WENDESCHNEIDPLATTEN TGTC</p>	AKL-TD-32-2	TD. - 2	106,00 €
	AKL-TD-32-3	TD. - 3	106,00 €

BLOCKS FOR PARTING AND DEEP GROOVING BLADES / Spannblock für Stechschwert		PRICE / PREIS
	ALBU-20-26	92,00 €
	ALBU-20-32	92,00 €
	ALBU-25-26	102,00 €
	ALBU-25-32	102,00 €
	ALBU-32-32	112,00 €

INTERNAL GROOVING TOOLHOLDERS / INNEN- STECHHALTER		CUTTING INSERT WENDE PLATTE	PRICE / PREIS
 <p>COMPATIBLE WITH KRLY-JD INSERT KOMPATIBEL FÜR WENDESCHNEIDPLATTEN KRLY-JD</p>	AIKT-K-R/L-16-2-T4	MGM. - 2	62,00 €
	AIKT-K-R/L-20-2-T4	MGM. - 2	67,00 €
	AIKT-K-R/L-25-2-T6	MGM. - 2	72,00 €
	AIKT-K-R/L-20-3-T6	MGM. - 3	67,00 €
	AIKT-K-R/L-20-3-T7	MGM. - 3	71,00 €
	AIKT-K-R/L-25-3-T6	MGM. - 3	72,00 €
	AIKT-K-R/L-25-3-T10	MGM. - 3	80,00 €
	AIKT-K-R/L-32-3-T6	MGM. - 3	85,00 €
	AIKT-K-R/L-32-3-T12	MGM. - 3	92,00 €
	AIKT-K-R/L-40-3-T6	MGM. - 3	102,00 €
	AIKT-K-R/L-40-3-T12	MGM. - 3	112,00 €
	AIKT-K-R/L-20-4-T6	MGM. - 4	67,00 €
	AIKT-K-R/L-20-4-T7	MGM. - 4	71,00 €
	AIKT-K-R/L-25-4-T6	MGM. - 4	72,00 €
	AIKT-K-R/L-25-4-T10	MGM. - 4	80,00 €
	AIKT-K-R/L-32-4-T6	MGM. - 4	85,00 €
	AIKT-K-R/L-32-4-T12	MGM. - 4	92,00 €
	AIKT-K-R/L-40-4-T6	MGM. - 4	102,00 €
	AIKT-K-R/L-40-4-T12	MGM. - 4	112,00 €
	AIKT-K-R/L-25-5-T7	MGM. - 5	72,00 €
	AIKT-K-R/L-32-5-T7	MGM. - 5	85,00 €
AIKT-K-R/L-40-5-T7	MGM. - 5	102,00 €	
^{NEW} AIKT-K-R/L-40-5-T12	MGM. - 5	112,00 €	
 <p>COMPATIBLE WITH KRLY INSERT KOMPATIBEL FÜR WENDESCHNEIDPLATTEN KRLY</p>	AIKT-KG-R/L-25-2-T7	KG.. - 2	80,00 €
	^{NEW} AIKT-KG-R/L-20-3-T6.5-H	KG.. - 3	88,00 €
	AIKT-KG-R/L-25-3-T7	KG.. - 3	80,00 €
	AIKT-KG-R/L-40-3-T8	KG.. - 3	112,00 €
	AIKT-KG-R/L-25-4-T8	KG.. - 4	80,00 €
 <p>COMPATIBLE WITH HRN INSERT KOMPATIBEL FÜR WENDESCHNEIDPLATTEN HRN</p>	AIKT-H-R/L-25-3-T8	S229 - 3	72,00 €
	AIKT-H-R/L-32-3-T7	S229 - 3	85,00 €
	AIKT-H-R/L-40-3-T7	S229 - 3	102,00 €
	AIKT-H-R/L-25-4-T8	S229 - 4	72,00 €
	AIKT-H-R/L-32-4-T7	S229 - 4	85,00 €
	AIKT-H-R/L-40-4-T7	S229 - 4	102,00 €
	AIKT-H-R/L-25-5-T7	S229 - 5	72,00 €
	AIKT-H-R/L-32-5-T7	S229 - 5	85,00 €
	AIKT-H-R/L-40-5-T7	S229 - 5	102,00 €

INTERNAL GROOVING TOOLHOLDERS / INNEN- STECHHALTER		CUTTING INSERT WENDE PLATTE	PRICE / PREIS
 <p>COMPATIBLE WITH HRN INSERT KOMPATIBEL FÜR WENDESCHNEIDPLATTEN HRN</p>	AIKT-HK-R/L-20-2-T6	S224 - 2	67,00 €
	AIKT-HK-R/L-25-2-T6	S224 - 2	72,00 €
	AIKT-HK-R/L-20-3-T6	S224 - 3	67,00 €
	AIKT-HK-R/L-25-3-T6	S224 - 3	72,00 €
	AIKT-HK-R/L-32-3-T6	S224 - 3	85,00 €
	AIKT-HK-R/L-20-4-T6	S224 - 4	67,00 €
	AIKT-HK-R/L-25-4-T6	S224 - 4	72,00 €
	AIKT-HK-R/L-32-4-T6	S224 - 4	85,00 €
	AIKT-HS223-R/L-20-2-T5	S223 - 2	67,00 €
	AIKT-HS223-R/L-25-2-T5	S223 - 2	72,00 €
	AIKT-HS223-R/L-20-3-T6	S223 - 3	67,00 €
AIKT-HS223-R/L-25-3-T6	S223 - 3	72,00 €	
 <p>COMPATIBLE WITH SNDVK INSERT KOMPATIBEL FÜR WENDESCHNEIDPLATTEN SNDVK</p>	AIKT-154.91-R/L-16-3-T3	154.91 - 3	62,00 €
	AIKT-154.91-R/L-20-3-T4	154.91 - 3	67,00 €
	AIKT-154.91-R/L-25-3-T4	154.91 - 3	72,00 €
	AIKT-154.91-R/L-25-5-T5	154.91 - 5	72,00 €
	AIKT-154.91-R/L-32-5-T5	154.91 - 5	85,00 €
 <p>COMPATIBLE WITH ZCC INSERT KOMPATIBEL FÜR WENDESCHNEIDPLATTEN ZCC</p>	AIKT-ZCC2-R/L-16-2-T4	Z.BD - 2	62,00 €
	AIKT-ZCC2-R/L-20-3-T5	Z.FD - 3	67,00 €
	<small>NEW</small> AIKT-ZCC2-R/L-20-3-T8	Z.FD - 3	71,00 €
	AIKT-ZCC2-R/L-25-3-T5	Z.FD - 3	72,00 €
	<small>NEW</small> AIKT-ZCC2-R/L-25-3-T10	Z.FD - 3	80,00 €
	AIKT-ZCC2-R/L-32-3-T6	Z.FD - 3	85,00 €
	AIKT-ZCC2-R/L-32-3-T8	Z.FD - 3	96,00 €
	<small>NEW</small> AIKT-ZCC2-R/L-32-3-T13	Z.FD - 3	105,00 €
	<small>NEW</small> AIKT-ZCC2-R/L-40-3-T12	Z.FD - 3	112,00 €
	AIKT-ZCC2-R/L-25-4-T6	Z.GD - 4	72,00 €
	AIKT-ZCC2-R/L-32-4-T7	Z.GD - 4	85,00 €
	AIKT-ZCC2-R/L-32-4-T8	Z.GD - 4	96,00 €
	AIKT-ZCC2-R/L-32-4-T10	Z.GD - 4	96,00 €
	AIKT-ZCC2-R/L-32-5-T7	Z.HD - 5	85,00 €
	AIKT-ZCC2-R/L-32-5-T8	Z.HD - 5	96,00 €
	AIKT-ZCC2-R/L-40-5-T8	Z.HD - 5	102,00 €
	AIKT-ZCC2-R/L-40-5-T10	Z.HD - 5	112,00 €
	 <p>COMPATIBLE WITH IGCR INSERT KOMPATIBEL FÜR WENDESCHNEIDPLATTEN IGCR</p>	<small>NEW</small> AIKT-IGE-R/L-10-2-T3-H	GEPI - 2
AIKT-IGE-R/L-16-2-T2.5-H		GEPI - 2	81,00 €
AIKT-IGE-R/L-16-3-T2.5-H		GEPI - 3	81,00 €
<small>NEW</small> AIKT-IGE-R/L-16-3-T2.5-D20		GEPI - 3	74,00 €

INTERNAL GROOVING TOOLHOLDERS / INNEN- STECHHALTER		CUTTING INSERT WENDE PLATTE	PRICE / PREIS
 <p>COMPATIBLE WITH KNMTL INSERT KOMPATIBEL FÜR WENDESCHNEIDPLATTEN KNMTL</p>	AIKT-KM-R/L-20-2-T7	A4. - 2	67,00 €
	AIKT-KM-R/L-20-3-T7	A4. - 3	67,00 €
	AIKT-KM-R/L-25-3-T10	A4. - 3	72,00 €
	AIKT-KM-R/L-32-3-T12	A4. - 3	85,00 €
	AIKT-KM-R/L-40-3-T12	A4. - 3	102,00 €
	AIKT-KM-R/L-20-4-T7	A4. - 4	67,00 €
 <p>NEW COMPATIBLE WITH TGTC INSERT KOMPATIBEL FÜR WENDESCHNEIDPLATTEN TGTC</p>	AIKT-TD-R/L-16-2-T8.5-H	TD. - 2	81,00 €
	AIKT-TD-R/L-20-3-T6-H	TD. - 3	89,00 €
	AIKT-TD-R/L-25-3-T6-H	TD. - 3	98,00 €
	AIKT-TD-R/L-32-3-T5-H	TD. - 3	118,00 €
 <p>COMPATIBLE WITH ISCR INSERT KOMPATIBEL FÜR WENDESCHNEIDPLATTEN ISCR</p>	AIKT-ITG-R/L-16-3-T6-H	TGM. - 3	81,00 €
	AIKT-ITG-R/L-20-3-T6-H	TGM. - 3	89,00 €
	AIKT-ITG-R/L-25-3-T8-H	TGM. - 3	98,00 €
	AIKT-ITG-R/L-32-3-T8-H	TGM. - 3	118,00 €
	AIKT-ITG-R/L-20-4-T6-H	TGM. - 4	89,00 €
	AIKT-ITG-R/L-25-4-T7-H	TGM. - 4	98,00 €
	AIKT-ITG-R/L-25-4-T9-H	TGM. - 4	102,00 €
	AIKT-ITG-R/L-32-4-T11-H	TGM. - 4	118,00 €
	AIKT-ITG-R/L-40-4-T11-H	TGM. - 4	204,00 €
	NEW AIKT-ITG-R/L-32-6.35-T17.5-H	TGM. - 6.35	161,00 €
 <p>COMPATIBLE WITH ISCR INSERT KOMPATIBEL FÜR WENDESCHNEIDPLATTEN ISCR</p>	AIKT-IG-R/L-25-4-T10-H	DGN / GRP - 4	102,00 €
	AIKT-IG-R/L-32-4-T10-H	DGN / GRP - 4	123,00 €
	AIKT-IG-R/L-40-4-T12-H	DGN / GRP - 4	204,00 €
	AIKT-IG-R/L-25-5-T10-H	DGN / GRP - 5	102,00 €
	AIKT-IG-R/L-32-5-T10-H	DGN / GRP - 5	123,00 €
	AIKT-IG-R/L-40-5-T12-H	DGN / GRP - 5	204,00 €
	AIKT-IG-R/L-50-5-T12-H	DGN / GRP - 5	255,00 €
 <p>COMPATIBLE WITH ISCR INSERT KOMPATIBEL FÜR WENDESCHNEIDPLATTEN ISCR</p>	AIKT-IGI-R/L-20-3-T4	GIMIY / GIPI - 3	89,00 €
	AIKT-IGI-R/L-25-3-T5	GIMIY / GIPI - 3	98,00 €
	AIKT-IGI-R/L-32-3-T5	GIMIY / GIPI - 3	118,00 €
	NEW AIKT-IGI-R/L-40-3-T5	GIMIY / GIPI - 3	142,00 €
	AIKT-IGI-R/L-20-4-T4	GIMIY / GIPI - 4	89,00 €
	NEW AIKT-IGI-R/L-25-5-T10	GIMIY / GIPI - 5	98,00 €
	NEW AIKT-IGI-R/L-25-5-T15	GIMIY / GIPI - 5	118,00 €

INTERNAL GROOVING TOOLHOLDERS / INNEN- STECHHALTER		CUTTING INSERT WENDE PLATTE	PRICE / PREIS
 <p>COMPATIBLE WITH ISCR INSERT KOMPATIBEL FÜR WENDESCHNEIDPLATTEN ISCR</p>	AIKT-I-R/L-20-3-T5	DGN - 3	67,00 €
	AIKT-I-R/L-25-3-T6	DGN - 3	72,00 €
 <p>COMPATIBLE WITH PLBT INSERT KOMPATIBEL FÜR WENDESCHNEIDPLATTEN PLBT</p>	AIKT-GP-R/L-20-2-T4	GP - 2	71,00 €
	NEW AIKT-GP-R/L-25-2-T6	GP - 2	80,00 €
	AIKT-GP-R/L-20-3-T6	GP - 3	71,00 €
	AIKT-GP-R/L-25-3-T6	GP - 3	80,00 €
	AIKT-GP-R/L-32-3-T6	GP - 3	92,00 €
	AIKT-GP-R/L-20-4-T6	GP - 4	71,00 €
	AIKT-GP-R/L-25-4-T6	GP - 4	80,00 €
AIKT-GP-R/L-32-4-T6	GP - 4	92,00 €	
 <p>COMPATIBLE WITH SMTM INSERT KOMPATIBEL FÜR WENDESCHNEIDPLATTEN SMTM</p>	AIKT-SGC-R/L-25-3-T6	GCM N30	80,00 €
	AIKT-SGC-R/L-32-3-T6	GCM N30	131,00 €
	AIKT-SGC-R/L-40-3-T6	GCM N30	152,00 €
 <p>COMPATIBLE WITH SNDVK INSERT KOMPATIBEL FÜR WENDESCHNEIDPLATTEN SNDVK</p>	NEW AIKT-123-R/L-20-2-T6	123 - 2	67,00 €
	NEW AIKT-123-R/L-25-2-T6	123 - 2	72,00 €
	AIKT-123-R/L-32-2-T7	123 - 2	85,00 €
	AIKT-123-R/L-20-3-T6	123 - 3	67,00 €
	AIKT-123-R/L-25-3-T7	123 - 3	72,00 €
	AIKT-123-R/L-32-3-T9	123 - 3	92,00 €
	AIKT-123-R/L-20-4-T8	123 - 4	71,00 €
	AIKT-123-R/L-25-4-T7	123 - 4	72,00 €
	AIKT-123-R/L-32-4-T7	123 - 4	85,00 €
	AIKT-123-R/L-32-4-T10	123 - 4	92,00 €
	AIKT-123-R/L-25-5-T8	123 - 5	72,00 €
AIKT-123-R/L-32-5-T11	123 - 5	92,00 €	
MINI GROOVING TOOL / MINI - STECHWERKZEUGE		CUTTING INSERT WENDE PLATTE	PRICE / PREIS
 <p>COMPATIBLE WITH SNDVK INSERT KOMPATIBEL FÜR WENDESCHNEIDPLATTEN SNDVK</p>	AIKT-MB07-A16-090-15	MB - 07	92,00 €
	AIKT-MB07-A16-090-22	MB - 07	92,00 €
	AIKT-MB09-A16-090-19	MB - 09	92,00 €
	AIKT-MB09-A16-110-40	MB - 09	92,00 €
	AIKT-MB09-A16-095-28	MB - 09	92,00 €

U-DRILL SYSTEM / VOLLBOHRER (WCM.)

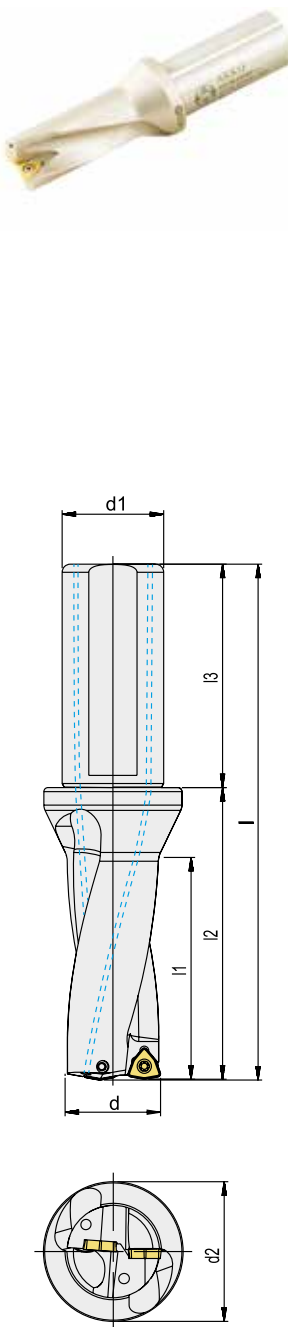
	CODE / TYP	TOOL DIMENSIONS (mm) MAß						CUTTING INSERT WENDE PLATTE	PRICE / PREIS
		d	d ₁	d ₂	l ₁	l ₂	l ₃		
	ATUM 16XD2 WCM. 030208	16	25	34	32	54	56	WCM. 030208	147,00 €
	ATUM 16.5XD2 WCM. 030208	16,5	25	34	32	54	56	WCM. 030208	147,00 €
	ATUM 17XD2 WCM. 030208	17	25	34	34	56	56	WCM. 030208	147,00 €
	ATUM 17.5XD2 WCM. 030208	17,5	25	34	34	56	56	WCM. 030208	147,00 €
	ATUM 18XD2 WCM. 030208	18	25	34	36	58	56	WCM. 030208	147,00 €
	ATUM 18.5XD2 WCM. 030208	18,5	25	34	36	58	56	WCM. 030208	147,00 €
	ATUM 19XD2 WCM. 030208	19	25	34	38	60	56	WCM. 030208	147,00 €
	ATUM 19.5XD2 WCM. 030208	19,5	25	34	38	60	56	WCM. 030208	147,00 €
	ATUM 20XD2 WCM. 040208	20	25	34	40	62	56	WCM. 040208	157,00 €
	ATUM 20.5XD2 WCM. 040208	20,5	25	34	40	62	56	WCM. 040208	157,00 €
	ATUM 21XD2 WCM. 040208	21	25	34	42	64	56	WCM. 040208	157,00 €
	ATUM 21.5XD2 WCM. 040208	21,5	25	34	42	64	56	WCM. 040208	157,00 €
	ATUM 22XD2 WCM. 040208	22	25	34	44	66	56	WCM. 040208	157,00 €
	ATUM 22.5XD2 WCM. 040208	22,5	25	34	44	66	56	WCM. 040208	157,00 €
	ATUM 23XD2 WCM. 040208	23	25	34	46	68	56	WCM. 040208	157,00 €
	ATUM 23.5XD2 WCM. 040208	23,5	25	34	46	68	56	WCM. 040208	157,00 €
	ATUM 24XD2 WCM. 050308	24	25	34	48	70	56	WCM. 050308	163,00 €
	ATUM 24.5XD2 WCM. 050308	24,5	25	34	48	70	56	WCM. 050308	163,00 €
	ATUM 25XD2 WCM. 050308	25	25	34	50	72	56	WCM. 050308	163,00 €
	ATUM 25.5XD2 WCM. 050308	25,5	25	34	50	72	56	WCM. 050308	163,00 €
	ATUM 26XD2 WCM. 050308	26	25	34	52	74	56	WCM. 050308	163,00 €
	ATUM 26.5XD2 WCM. 050308	26,5	25	34	52	74	56	WCM. 050308	163,00 €
	ATUM 27XD2 WCM. 050308	27	25	34	54	76	56	WCM. 050308	163,00 €
	ATUM 27.5XD2 WCM. 050308	27,5	25	34	54	76	56	WCM. 050308	163,00 €
	ATUM 28XD2 WCM. 050308	28	25	34	56	78	56	WCM. 050308	163,00 €
	ATUM 28.5XD2 WCM. 050308	28,5	25	34	56	78	56	WCM. 050308	163,00 €
	ATUM 29XD2 WCM. 050308	29	25	34	58	80	56	WCM. 050308	163,00 €
	ATUM 29.5XD2 WCM. 050308	29,5	25	34	58	80	56	WCM. 050308	163,00 €
	ATUM 30XD2 WCM. 06T308	30	32	44	60	87	60	WCM. 06T308	174,00 €
	ATUM 31XD2 WCM. 06T308	31	32	44	62	89	60	WCM. 06T308	174,00 €
	ATUM 32XD2 WCM. 06T308	32	32	44	64	91	60	WCM. 06T308	174,00 €
	ATUM 33XD2 WCM. 06T308	33	32	44	66	93	60	WCM. 06T308	174,00 €
	ATUM 34XD2 WCM. 06T308	34	32	44	68	95	60	WCM. 06T308	174,00 €
	ATUM 35XD2 WCM. 06T308	35	32	44	70	97	60	WCM. 06T308	174,00 €
	ATUM 36XD2 WCM. 06T308	36	32	44	72	99	60	WCM. 06T308	174,00 €
	ATUM 37XD2 WCM. 06T308	37	32	44	74	101	60	WCM. 06T308	174,00 €
	ATUM 38XD2 WCM. 06T308	38	32	44	76	103	60	WCM. 06T308	174,00 €
	ATUM 39XD2 WCM. 06T308	39	32	44	78	105	60	WCM. 06T308	174,00 €
	ATUM 40XD2 WCM. 06T308	40	32	44	80	107	60	WCM. 06T308	174,00 €
	ATUM 41XD2 WCM. 06T308	41	32	44	82	109	60	WCM. 06T308	180,00 €
	ATUM 42XD2 WCM. 06T308	42	32	44	84	111	60	WCM. 06T308	180,00 €
	ATUM 43XD2 WCM. 06T308	43	32	44	86	113	60	WCM. 06T308	180,00 €
	ATUM 44XD2 WCM. 06T308	44	32	44	88	115	60	WCM. 06T308	180,00 €
	ATUM 45XD2 WCM. 080412	45	40	54	90	122	70	WCM. 080412	197,00 €
	ATUM 46XD2 WCM. 080412	46	40	54	92	124	70	WCM. 080412	208,00 €
	ATUM 47XD2 WCM. 080412	47	40	54	94	126	70	WCM. 080412	225,00 €
	ATUM 48XD2 WCM. 080412	48	40	54	96	128	70	WCM. 080412	237,00 €
	ATUM 49XD2 WCM. 080412	49	40	54	98	130	70	WCM. 080412	248,00 €
	ATUM 50XD2 WCM. 080412	50	40	54	100	132	70	WCM. 080412	259,00 €
	ATUM 51XD2 WCM. 080412	51	40	54	102	134	70	WCM. 080412	270,00 €
	ATUM 52XD2 WCM. 080412	52	40	54	104	136	70	WCM. 080412	282,00 €
	ATUM 53XD2 WCM. 080412	53	40	54	106	138	70	WCM. 080412	293,00 €
	ATUM 54XD2 WCM. 080412	54	40	54	108	140	70	WCM. 080412	304,00 €
	ATUM 55XD2 WCM. 080412	55	40	54	110	142	70	WCM. 080412	304,00 €
	ATUM 56XD2 WCM. 080412	56	40	59	112	144	70	WCM. 080412	304,00 €
	ATUM 57XD2 WCM. 080412	57	40	59	114	146	70	WCM. 080412	326,00 €
	ATUM 58XD2 WCM. 080412	58	40	59	116	148	70	WCM. 080412	326,00 €
	ATUM 59XD2 WCM. 080412	59	40	59	118	150	70	WCM. 080412	326,00 €
	ATUM 60XD2 WCM. 080412	60	40	59	120	152	70	WCM. 080412	326,00 €

COMPATIBLE WITH ISO INSERT
KOMPATIBEL FÜR WENDESCHNEIDPLATTEN ISO

U-DRILL SYSTEM / VOLLBOHRER (WCM.)

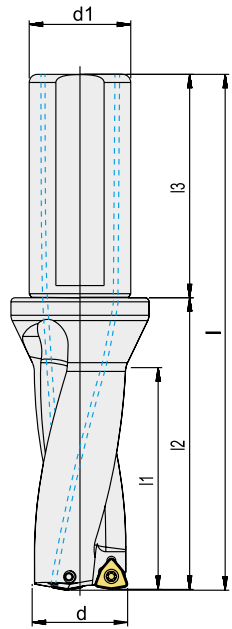
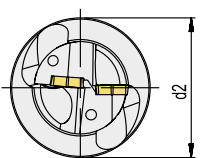
	CODE / TYP	TOOL DIMENSIONS (mm) <i>MAß</i>						CUTTING INSERT <i>WENDE PLATTE</i>	PRICE / PREIS
		d	d ₁	d ₂	l ₁	l ₂	l ₃		
D3   	ATUM 16XD3 WCM. 030208	16	25	34	48	70	56	WCM. 030208	157,00 €
	ATUM 16.5XD3 WCM. 030208	16.5	25	34	48	70	56	WCM. 030208	157,00 €
	ATUM 17XD3 WCM. 030208	17	25	34	51	73	56	WCM. 030208	157,00 €
	ATUM 17.5XD3 WCM. 030208	17.5	25	34	51	73	56	WCM. 030208	157,00 €
	ATUM 18XD3 WCM. 030208	18	25	34	54	76	56	WCM. 030208	157,00 €
	ATUM 18.5XD3 WCM. 030208	18.5	25	34	54	76	56	WCM. 030208	157,00 €
	ATUM 19XD3 WCM. 030208	19	25	34	57	79	56	WCM. 030208	157,00 €
	ATUM 19.5XD3 WCM. 030208	19.5	25	34	57	79	56	WCM. 030208	157,00 €
	ATUM 20XD3 WCM. 040208	20	25	34	60	82	56	WCM. 040208	163,00 €
	ATUM 20.5XD3 WCM. 040208	20.5	25	34	60	82	56	WCM. 040208	163,00 €
	ATUM 21XD3 WCM. 040208	21	25	34	63	85	56	WCM. 040208	163,00 €
	ATUM 21.5XD3 WCM. 040208	21.5	25	34	63	85	56	WCM. 040208	163,00 €
	ATUM 22XD3 WCM. 040208	22	25	34	66	88	56	WCM. 040208	163,00 €
	ATUM 22.5XD3 WCM. 040208	22.5	25	34	66	88	56	WCM. 040208	163,00 €
	ATUM 23XD3 WCM. 040208	23	25	34	69	91	56	WCM. 040208	163,00 €
	ATUM 23.5XD3 WCM. 040208	23.5	25	34	69	91	56	WCM. 040208	163,00 €
	ATUM 24XD3 WCM. 050308	24	25	34	72	94	56	WCM. 050308	169,00 €
	ATUM 24.5XD3 WCM. 050308	24.5	25	34	72	94	56	WCM. 050308	169,00 €
	ATUM 25XD3 WCM. 050308	25	25	34	75	97	56	WCM. 050308	169,00 €
	ATUM 25.5XD3 WCM. 050308	25.5	25	34	75	97	56	WCM. 050308	169,00 €
	ATUM 26XD3 WCM. 050308	26	25	34	78	100	56	WCM. 050308	169,00 €
	ATUM 26.5XD3 WCM. 050308	26.5	25	34	78	100	56	WCM. 050308	169,00 €
	ATUM 27XD3 WCM. 050308	27	25	34	81	103	56	WCM. 050308	169,00 €
	ATUM 27.5XD3 WCM. 050308	27.5	25	34	81	103	56	WCM. 050308	169,00 €
	ATUM 28XD3 WCM. 050308	28	25	34	84	106	56	WCM. 050308	169,00 €
	ATUM 28.5XD3 WCM. 050308	28.5	25	34	84	106	56	WCM. 050308	169,00 €
	ATUM 29XD3 WCM. 050308	29	25	34	87	109	56	WCM. 050308	169,00 €
	ATUM 29.5XD3 WCM. 050308	29.5	25	34	87	109	56	WCM. 050308	169,00 €
	ATUM 30XD3 WCM. 06T308	30	32	44	90	117	60	WCM. 06T308	174,00 €
	ATUM 30.5XD3 WCM. 06T308	30.5	32	44	90	117	60	WCM. 06T308	174,00 €
	ATUM 31XD3 WCM. 06T308	31	32	44	93	120	60	WCM. 06T308	174,00 €
	ATUM 31.5XD3 WCM. 06T308	31.5	32	44	93	120	60	WCM. 06T308	174,00 €
	ATUM 32XD3 WCM. 06T308	32	32	44	96	123	60	WCM. 06T308	174,00 €
	ATUM 32.5XD3 WCM. 06T308	32.5	32	44	96	123	60	WCM. 06T308	174,00 €
	ATUM 33XD3 WCM. 06T308	33	32	44	99	126	60	WCM. 06T308	174,00 €
	ATUM 33.5XD3 WCM. 06T308	33.5	32	44	99	126	60	WCM. 06T308	174,00 €
	ATUM 34XD3 WCM. 06T308	34	32	44	102	129	60	WCM. 06T308	174,00 €
	ATUM 34.5XD3 WCM. 06T308	34.5	32	44	102	129	60	WCM. 06T308	174,00 €
	ATUM 35XD3 WCM. 06T308	35	32	44	105	132	60	WCM. 06T308	174,00 €
	ATUM 35.5XD3 WCM. 06T308	35.5	32	44	105	132	60	WCM. 06T308	174,00 €
	ATUM 36XD3 WCM. 06T308	36	32	44	108	135	60	WCM. 06T308	174,00 €
	ATUM 36.5XD3 WCM. 06T308	36.5	32	44	108	135	60	WCM. 06T308	174,00 €
	ATUM 37XD3 WCM. 06T308	37	32	44	111	138	60	WCM. 06T308	174,00 €
	ATUM 37.5XD3 WCM. 06T308	37.5	32	44	111	138	60	WCM. 06T308	174,00 €
ATUM 38XD3 WCM. 06T308	38	32	44	114	141	60	WCM. 06T308	174,00 €	
ATUM 38.5XD3 WCM. 06T308	38.5	32	44	114	141	60	WCM. 06T308	174,00 €	
ATUM 39XD3 WCM. 06T308	39	32	44	117	144	60	WCM. 06T308	174,00 €	
ATUM 39.5XD3 WCM. 06T308	39.5	32	44	117	144	60	WCM. 06T308	174,00 €	
ATUM 40XD3 WCM. 06T308	40	32	44	120	147	60	WCM. 06T308	174,00 €	
ATUM 40.5XD3 WCM. 06T308	40.5	32	44	120	147	60	WCM. 06T308	174,00 €	
ATUM 41XD3 WCM. 06T308	41	32	44	123	150	60	WCM. 06T308	192,00 €	
ATUM 41.5XD3 WCM. 06T308	41.5	32	44	123	150	60	WCM. 06T308	192,00 €	
ATUM 42XD3 WCM. 06T308	42	32	44	126	153	60	WCM. 06T308	192,00 €	
ATUM 42.5XD3 WCM. 06T308	42.5	32	44	126	153	60	WCM. 06T308	192,00 €	
ATUM 43XD3 WCM. 06T308	43	32	44	129	156	60	WCM. 06T308	192,00 €	
ATUM 43.5XD3 WCM. 06T308	43.5	32	44	129	156	60	WCM. 06T308	192,00 €	
ATUM 44XD3 WCM. 06T308	44	32	44	132	159	60	WCM. 06T308	192,00 €	
ATUM 44.5XD3 WCM. 06T308	44.5	32	44	132	159	60	WCM. 06T308	192,00 €	

COMPATIBLE WITH ISO INSERT
KOMPATIBEL FÜR WENDESCHNEIDPLATTEN ISO

U-DRILL SYSTEM / VOLLBOHRER (WCM.)

	CODE / TYP	TOOL DIMENSIONS (mm) <i>MAß</i>						CUTTING INSERT WENDE PLATTE	PRICE / PREIS
		d	d ₁	d ₂	l ₁	l ₂	l ₃		
 <p>D3</p> <p>COMPATIBLE WITH ISO INSERT KOMPATIBEL FÜR WENDESCHNEIDPLATTEN ISO</p>	ATUM 45XD3 WCM. 080412	45	40	54	135	167	70	WCM. 080412	202,00 €
	ATUM 45.5XD3 WCM. 080412	45.5	40	54	135	167	70	WCM. 080412	214,00 €
	ATUM 46XD3 WCM. 080412	46	40	54	138	170	70	WCM. 080412	225,00 €
	ATUM 47XD3 WCM. 080412	47	40	54	141	173	70	WCM. 080412	237,00 €
	ATUM 48XD3 WCM. 080412	48	40	54	144	176	70	WCM. 080412	248,00 €
	ATUM 49XD3 WCM. 080412	49	40	54	147	179	70	WCM. 080412	270,00 €
	ATUM 50XD3 WCM. 080412	50	40	54	150	182	70	WCM. 080412	282,00 €
	ATUM 51XD3 WCM. 080412	51	40	54	153	185	70	WCM. 080412	293,00 €
	ATUM 52XD3 WCM. 080412	52	40	54	156	188	70	WCM. 080412	304,00 €
	ATUM 53XD3 WCM. 080412	53	40	54	159	191	70	WCM. 080412	315,00 €
	ATUM 54XD3 WCM. 080412	54	40	54	162	194	70	WCM. 080412	315,00 €
	ATUM 55XD3 WCM. 080412	55	40	54	165	197	70	WCM. 080412	315,00 €
	ATUM 56XD3 WCM. 080412	56	40	59	168	200	70	WCM. 080412	338,00 €
	ATUM 57XD3 WCM. 080412	57	40	59	171	203	70	WCM. 080412	338,00 €
	ATUM 58XD3 WCM. 080412	58	40	59	174	206	70	WCM. 080412	338,00 €
ATUM 59XD3 WCM. 080412	59	40	59	177	209	70	WCM. 080412	338,00 €	
ATUM 60XD3 WCM. 080412	60	40	59	180	212	70	WCM. 080412	338,00 €	

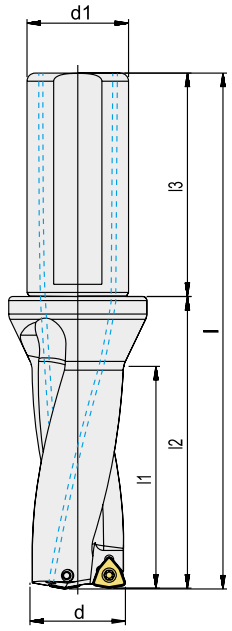
	CODE / TYP	TOOL DIMENSIONS (mm) <i>MAß</i>						CUTTING INSERT WENDE PLATTE	PRICE / PREIS
		d	d ₁	d ₂	l ₁	l ₂	l ₃		
 <p>D4</p>  <p>COMPATIBLE WITH ISO INSERT KOMPATIBEL FÜR WENDESCHNEIDPLATTEN ISO</p>	ATUM 16XD4 WCM. 030208	16	25	34	64	86	56	WCM. 030208	259,00 €
	ATUM 17XD4 WCM. 030208	17	25	34	68	90	56	WCM. 030208	259,00 €
	ATUM 17.5XD4 WCM. 030208	17.5	25	34	68	90	56	WCM. 030208	259,00 €
	ATUM 18XD4 WCM. 030208	18	25	34	72	94	56	WCM. 030208	259,00 €
	ATUM 19XD4 WCM. 030208	19	25	34	76	98	56	WCM. 030208	259,00 €
	ATUM 20XD4 WCM. 040208	20	25	34	80	102	56	WCM. 040208	270,00 €
	ATUM 21XD4 WCM. 040208	21	25	34	84	106	56	WCM. 040208	270,00 €
	ATUM 22XD4 WCM. 040208	22	25	34	88	110	56	WCM. 040208	270,00 €
	ATUM 22.5XD4 WCM. 040208	22.5	25	34	88	110	56	WCM. 040208	270,00 €
	ATUM 23XD4 WCM. 040208	23	25	34	92	114	56	WCM. 040208	270,00 €
	ATUM 24XD4 WCM. 050308	24	25	34	96	118	56	WCM. 050308	282,00 €
	ATUM 25XD4 WCM. 050308	25	25	34	100	122	56	WCM. 050308	282,00 €
	ATUM 26XD4 WCM. 050308	26	25	34	104	126	56	WCM. 050308	282,00 €
	ATUM 26.5XD4 WCM. 050308	26.5	25	34	104	126	56	WCM. 050308	282,00 €
	ATUM 27XD4 WCM. 050308	27	25	34	108	130	56	WCM. 050308	282,00 €
	ATUM 28XD4 WCM. 050308	28	25	34	112	134	56	WCM. 050308	282,00 €
	ATUM 28.5XD4 WCM. 050308	28.5	25	34	112	134	56	WCM. 050308	282,00 €
	ATUM 29XD4 WCM. 050308	29	25	34	116	138	56	WCM. 050308	282,00 €
	ATUM 30XD4 WCM. 06T308	30	32	44	120	147	60	WCM. 06T308	293,00 €
	ATUM 31XD4 WCM. 06T308	31	32	44	124	151	60	WCM. 06T308	293,00 €
	ATUM 32XD4 WCM. 06T308	32	32	44	128	155	60	WCM. 06T308	293,00 €
	ATUM 33XD4 WCM. 06T308	33	32	44	132	159	60	WCM. 06T308	293,00 €
	ATUM 33.5XD4 WCM. 06T308	33.5	32	44	132	159	60	WCM. 06T308	293,00 €
	ATUM 34XD4 WCM. 06T308	34	32	44	136	163	60	WCM. 06T308	293,00 €
	ATUM 35XD4 WCM. 06T308	35	32	44	140	167	60	WCM. 06T308	293,00 €
	ATUM 36XD4 WCM. 06T308	36	32	44	144	171	60	WCM. 06T308	293,00 €
	ATUM 37XD4 WCM. 06T308	37	32	44	148	175	60	WCM. 06T308	293,00 €
	ATUM 38XD4 WCM. 06T308	38	32	44	152	179	60	WCM. 06T308	293,00 €
	ATUM 38.5XD4 WCM. 06T308	38.5	32	44	152	179	60	WCM. 06T308	293,00 €
	ATUM 39XD4 WCM. 06T308	39	32	44	156	183	60	WCM. 06T308	293,00 €
	ATUM 40XD4 WCM. 06T308	40	32	44	160	187	60	WCM. 06T308	293,00 €
	ATUM 41XD4 WCM. 06T308	41	32	44	164	191	60	WCM. 06T308	315,00 €
	ATUM 42XD4 WCM. 06T308	42	32	44	168	195	60	WCM. 06T308	315,00 €
	ATUM 43XD4 WCM. 06T308	43	32	44	172	199	60	WCM. 06T308	315,00 €
	ATUM 44XD4 WCM. 06T308	44	32	44	176	203	60	WCM. 06T308	315,00 €
ATUM 45XD4 WCM. 080412	45	40	54	180	212	70	WCM. 080412	338,00 €	
ATUM 46XD4 WCM. 080412	46	40	54	184	216	70	WCM. 080412	360,00 €	
ATUM 47XD4 WCM. 080412	47	40	54	188	220	70	WCM. 080412	383,00 €	
ATUM 48XD4 WCM. 080412	48	40	54	192	224	70	WCM. 080412	405,00 €	
ATUM 49XD4 WCM. 080412	49	40	54	196	228	70	WCM. 080412	427,00 €	
ATUM 50XD4 WCM. 080412	50	40	54	200	232	70	WCM. 080412	450,00 €	

U-DRILL SYSTEM / VOLLBOHRER (SPMG)

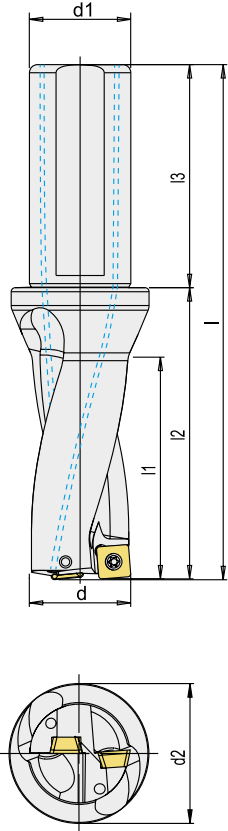
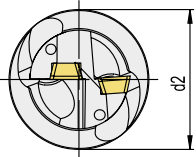
	CODE / TYP	TOOL DIMENSIONS (mm) <i>MAß</i>						CUTTING INSERT WENDE PLATTE	PRICE / PREIS
		d	d ₁	d ₂	l ₁	l ₂	l ₃		
D2   	ATUM 12.5XD2 SP.. 050204	12.5	20	25	24	46	50	SP.. 050204	147,00 €
	ATUM 13XD2 SP.. 050204	13	20	25	26	48	50	SP.. 050204	147,00 €
	ATUM 13.5XD2 SP.. 050204	13.5	20	25	26	48	50	SP.. 050204	147,00 €
	ATUM 14XD2 SP.. 050204	14	20	25	28	50	50	SP.. 050204	147,00 €
	ATUM 14.5XD2 SP.. 050204	14.5	20	25	28	50	50	SP.. 050204	147,00 €
	ATUM 15XD2 SP.. 050204	15	20	25	30	52	50	SP.. 050204	147,00 €
	ATUM 15.5XD2 SP.. 060204	15.5	20	25	30	52	50	SP.. 060204	147,00 €
	ATUM 16XD2 SP.. 060204	16	25	34	32	54	56	SP.. 060204	147,00 €
	ATUM 16.5XD2 SP.. 060204	16.5	25	34	32	54	56	SP.. 060204	147,00 €
	ATUM 17XD2 SP.. 060204	17	25	34	34	56	56	SP.. 060204	147,00 €
	ATUM 17.5XD2 SP.. 060204	17.5	25	34	34	56	56	SP.. 060204	147,00 €
	ATUM 18XD2 SP.. 060204	18	25	34	36	58	56	SP.. 060204	147,00 €
	ATUM 18.5D2 SP.. 060204	18.5	25	34	36	58	56	SP.. 060204	147,00 €
	ATUM 19XD2 SP.. 060204	19	25	34	38	60	56	SP.. 060204	147,00 €
	ATUM 19.5XD2 SP.. 060204	19.5	25	34	38	60	56	SP.. 060204	147,00 €
	ATUM 20XD2 SP.. 060204	20	25	34	40	62	56	SP.. 060204	157,00 €
	ATUM 20.5XD2 SP.. 060204	20.5	25	34	40	62	56	SP.. 060204	157,00 €
	ATUM 21XD2 SP.. 060204	21	25	34	42	64	56	SP.. 060204	157,00 €
	ATUM 21.5XD2 SP.. 060204	21.5	25	34	42	64	56	SP.. 060204	157,00 €
	ATUM 22XD2 SP.. 07T308	22	25	34	44	66	56	SP.. 07T308	157,00 €
	ATUM 22.5XD2 SP.. 07T308	22.5	25	34	44	66	56	SP.. 07T308	157,00 €
	ATUM 23XD2 SP.. 07T308	23	25	34	46	68	56	SP.. 07T308	157,00 €
	ATUM 23.5XD2 SP.. 07T308	23.5	25	34	46	68	56	SP.. 07T308	157,00 €
	ATUM 24XD2 SP.. 07T308	24	25	34	48	70	56	SP.. 07T308	163,00 €
	ATUM 24.5XD2 SP.. 07T308	24.5	25	34	48	70	56	SP.. 07T308	163,00 €
	ATUM 25XD2 SP.. 07T308	25	25	34	50	72	56	SP.. 07T308	163,00 €
	ATUM 25.5XD2 SP.. 07T308	25.5	25	34	50	72	56	SP.. 07T308	163,00 €
	ATUM 26XD2 SP.. 07T308	26	25	34	52	74	56	SP.. 07T308	163,00 €
	ATUM 26.5XD2 SP.. 07T308	26.5	25	34	52	74	56	SP.. 07T308	163,00 €
	ATUM 27XD2 SP.. 07T308	27	25	34	54	76	56	SP.. 07T308	163,00 €
	ATUM 27.5XD2 SP.. 07T308	27.5	25	34	54	76	56	SP.. 07T308	163,00 €
	ATUM 28XD2 SP.. 090408	28	25	34	56	78	56	SP.. 090408	163,00 €
	ATUM 28.5XD2 SP.. 090408	28.5	25	34	56	78	56	SP.. 090408	163,00 €
	ATUM 29XD2 SP.. 090408	29	25	34	58	80	56	SP.. 090408	163,00 €
	ATUM 29.5XD2 SP.. 090408	29.5	25	34	58	80	56	SP.. 090408	163,00 €
	ATUM 30XD2 SP.. 090408	30	32	44	60	87	60	SP.. 090408	174,00 €
	ATUM 31XD2 SP.. 090408	31	32	44	62	89	60	SP.. 090408	174,00 €
	ATUM 32XD2 SP.. 090408	32	32	44	64	91	60	SP.. 090408	174,00 €
	ATUM 33XD2 SP.. 090408	33	32	44	66	93	60	SP.. 090408	174,00 €
	ATUM 34XD2 SP.. 110408	34	32	44	68	95	60	SP.. 110408	174,00 €
	ATUM 35XD2 SP.. 110408	35	32	44	70	97	60	SP.. 110408	174,00 €
	ATUM 36XD2 SP.. 110408	36	32	44	72	99	60	SP.. 110408	174,00 €
	ATUM 37XD2 SP.. 110408	37	32	44	74	101	60	SP.. 110408	174,00 €
	ATUM 38XD2 SP.. 110408	38	32	44	76	103	60	SP.. 110408	174,00 €
	ATUM 39XD2 SP.. 110408	39	32	44	78	105	60	SP.. 110408	174,00 €
	ATUM 40XD2 SP.. 110408	40	32	44	80	107	60	SP.. 110408	174,00 €
	ATUM 41XD2 SP.. 110408	41	32	44	82	109	60	SP.. 110408	180,00 €
	ATUM 42XD2 SP.. 140512	42	32	44	84	111	60	SP.. 140512	180,00 €
	ATUM 43XD2 SP.. 140512	43	32	44	86	113	60	SP.. 140512	180,00 €
	ATUM 44XD2 SP.. 140512	44	32	44	88	115	60	SP.. 140512	180,00 €
ATUM 45XD2 SP.. 140512	45	40	54	90	122	70	SP.. 140512	197,00 €	
ATUM 46XD2 SP.. 140512	46	40	54	92	124	70	SP.. 140512	208,00 €	
ATUM 47XD2 SP.. 140512	47	40	54	94	126	70	SP.. 140512	225,00 €	
ATUM 48XD2 SP.. 140512	48	40	54	96	128	70	SP.. 140512	237,00 €	
ATUM 49XD2 SP.. 140512	49	40	54	98	130	70	SP.. 140512	248,00 €	
ATUM 50XD2 SP.. 140512	50	40	54	100	132	70	SP.. 140512	259,00 €	

COMPATIBLE WITH TGTC INSERT
KOMPATIBEL FÜR WENDESCHNEIDPLATTEN TGTC

U-DRILL SYSTEM / VOLLBOHRER (SPMG)

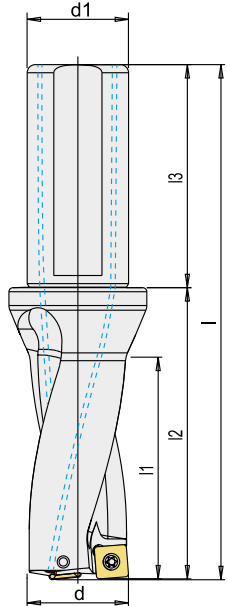
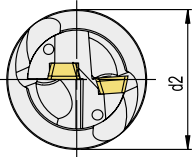
D3	CODE / TYP	TOOL DIMENSIONS (mm) <small>MAS</small>						CUTTING INSERT WENDE PLATTE	PRICE / PREIS
		d	d ₁	d ₂	l ₁	l ₂	l ₃		
	ATUM 12.5XD3 SP.. 050204	12,5	20	25	36	58	50	SP.. 050204	157,00 €
	ATUM 13XD3 SP.. 050204	13	20	25	39	61	50	SP.. 050204	157,00 €
	ATUM 13.5XD3 SP.. 050204	13,5	20	25	39	61	50	SP.. 050204	157,00 €
	ATUM 14XD3 SP.. 050204	14	20	25	42	64	50	SP.. 050204	157,00 €
	ATUM 14.5XD3 SP.. 050204	14,5	20	25	42	64	50	SP.. 050204	157,00 €
	ATUM 15XD3 SP.. 050204	15	20	25	45	67	50	SP.. 050204	157,00 €
	ATUM 15.5XD3 SP.. 060204	15,5	20	25	45	67	50	SP.. 060204	157,00 €
	ATUM 16XD3 SP.. 060204	16	25	34	48	70	56	SP.. 060204	157,00 €
	ATUM 16.5XD3 SP.. 060204	16,5	25	34	48	70	56	SP.. 060204	157,00 €
	ATUM 17XD3 SP.. 060204	17	25	34	51	73	56	SP.. 060204	157,00 €
	ATUM 17.5XD3 SP.. 060204	17,5	25	34	51	73	56	SP.. 060204	157,00 €
	ATUM 18XD3 SP.. 060204	18	25	34	54	76	56	SP.. 060204	157,00 €
	ATUM 18.5XD3 SP.. 060204	18,5	25	34	54	76	56	SP.. 060204	157,00 €
	ATUM 19xD3 SP.. 060204	19	25	34	57	79	56	SP.. 060204	157,00 €
	ATUM 19.5XD3 SP.. 060204	19,5	25	34	57	79	56	SP.. 060204	157,00 €
	ATUM 20XD3 SP.. 060204	20	25	34	60	82	56	SP.. 060204	163,00 €
	ATUM 20.5XD3 SP.. 060204	20,5	25	34	60	82	56	SP.. 060204	163,00 €
	ATUM 21XD3 SP.. 060204	21	25	34	63	85	56	SP.. 060204	163,00 €
	ATUM 21.5XD3 SP.. 060204	21,5	25	34	63	85	56	SP.. 060204	163,00 €
	ATUM 22XD3 SP.. 07T308	22	25	34	66	88	56	SP.. 07T308	163,00 €
	ATUM 22.5XD3 SP.. 07T308	22,5	25	34	66	88	56	SP.. 07T308	163,00 €
	ATUM 23XD3 SP.. 07T308	23	25	34	69	91	56	SP.. 07T308	163,00 €
	ATUM 23.5XD3 SP.. 07T308	23,5	25	34	69	91	56	SP.. 07T308	163,00 €
	ATUM 24XD3 SP.. 07T308	24	25	34	72	94	56	SP.. 07T308	169,00 €
	ATUM 24.5XD3 SP.. 07T308	24,5	25	34	72	94	56	SP.. 07T308	169,00 €
	ATUM 25XD3 SP.. 07T308	25	25	34	75	97	56	SP.. 07T308	169,00 €
	ATUM 25.5XD3 SP.. 07T308	25,5	25	34	75	97	56	SP.. 07T308	169,00 €
	ATUM 26XD3 SP.. 07T308	26	25	34	78	100	56	SP.. 07T308	169,00 €
	ATUM 26.5XD3 SP.. 07T308	26,5	25	34	78	100	56	SP.. 07T308	169,00 €
	ATUM 27XD3 SP.. 07T308	27	25	34	81	103	56	SP.. 07T308	169,00 €
	ATUM 27.5XD3 SP.. 07T308	27,5	25	34	81	103	56	SP.. 07T308	169,00 €
	ATUM 28XD3 SP.. 090408	28	25	34	84	106	56	SP.. 090408	169,00 €
	ATUM 28.5XD3 SP.. 090408	28,5	25	34	84	106	56	SP.. 090408	169,00 €
	ATUM 29XD3 SP.. 090408	29	25	34	87	109	56	SP.. 090408	169,00 €
	ATUM 29.5XD3 SP.. 090408	29,5	25	34	87	109	56	SP.. 090408	169,00 €
	ATUM 30XD3 SP.. 090408	30	32	44	90	117	60	SP.. 090408	174,00 €
	ATUM 30.5XD3 SP.. 090408	30,5	32	44	90	117	60	SP.. 090408	174,00 €
	ATUM 31XD3 SP.. 090408	31	32	44	93	120	60	SP.. 090408	174,00 €
	ATUM 31.5XD3 SP.. 090408	31,5	32	44	93	120	60	SP.. 090408	174,00 €
	ATUM 32XD3 SP.. 090408	32	32	44	96	123	60	SP.. 090408	174,00 €
	ATUM 32.5XD3 SP.. 090408	32,5	32	44	96	123	60	SP.. 090408	174,00 €
	ATUM 33XD3 SP.. 090408	33	32	44	99	126	60	SP.. 090408	174,00 €
	ATUM 33.5XD3 SP.. 090408	33,5	32	44	99	126	60	SP.. 090408	174,00 €
	ATUM 34XD3 SP.. 110408	34	32	44	102	129	60	SP.. 110408	174,00 €
	ATUM 34.5XD3 SP.. 110408	34,5	32	44	102	129	60	SP.. 110408	174,00 €
	ATUM 35XD3 SP.. 110408	35	32	44	105	132	60	SP.. 110408	174,00 €
	ATUM 35.5XD3 SP.. 110408	35,5	32	44	105	132	60	SP.. 110408	174,00 €
	ATUM 36XD3 SP.. 110408	36	32	44	108	135	60	SP.. 110408	174,00 €
	ATUM 36.5XD3 SP.. 110408	36,5	32	44	108	135	60	SP.. 110408	174,00 €
	ATUM 37XD3 SP.. 110408	37	32	44	111	138	60	SP.. 110408	174,00 €
	ATUM 37.5XD3 SP.. 110408	37,5	32	44	111	138	60	SP.. 110408	174,00 €
	ATUM 38XD3 SP.. 110408	38	32	44	114	141	60	SP.. 110408	174,00 €
	ATUM 38.5XD3 SP.. 110408	38,5	32	44	114	141	60	SP.. 110408	174,00 €
	ATUM 39XD3 SP.. 110408	39	32	44	117	144	60	SP.. 110408	174,00 €
	ATUM 39.5XD3 SP.. 110408	39,5	32	44	117	144	60	SP.. 110408	174,00 €
	ATUM 40XD3 SP.. 110408	40	32	44	120	147	60	SP.. 110408	174,00 €
	ATUM 40.5XD3 SP.. 110408	40,5	32	44	120	147	60	SP.. 110408	174,00 €
	ATUM 41XD3 SP.. 110408	41	32	44	123	150	60	SP.. 110408	192,00 €
	ATUM 41.5XD3 SP.. 110408	41,5	32	44	123	150	60	SP.. 110408	192,00 €
	ATUM 42XD3 SP.. 140512	42	32	44	126	153	60	SP.. 140512	192,00 €
	ATUM 42.5XD3 SP.. 140512	42,5	32	44	126	153	60	SP.. 140512	192,00 €

COMPATIBLE WITH TGTC INSERT
KOMPATIBEL FÜR WENDESCHNEIDPLATTEN TGTC

U-DRILL SYSTEM / VOLLBOHRER (SPMG)

	CODE / TYP	TOOL DIMENSIONS (mm) <i>MAß</i>						CUTTING INSERT WENDE PLATTE	PRICE / PREIS
		d	d ₁	d ₂	l ₁	l ₂	l ₃		
D3 	ATUM 43XD3 SP.. 140512	43	32	44	129	156	60	SP.. 140512	192,00 €
	ATUM 43.5XD3 SP.. 140512	43.5	32	44	129	156	60	SP.. 140512	192,00 €
	ATUM 44XD3 SP.. 140512	44	32	44	132	159	60	SP.. 140512	192,00 €
	ATUM 44.5XD3 SP.. 140512	44.5	32	44	132	159	60	SP.. 140512	192,00 €
	ATUM 45XD3 SP.. 140512	45	40	54	135	167	70	SP.. 140512	202,00 €
	ATUM 45.5XD3 SP.. 140512	45.5	40	54	135	167	70	SP.. 140512	202,00 €
	ATUM 46XD3 SP.. 140512	46	40	54	138	170	70	SP.. 140512	214,00 €
	ATUM 47XD3 SP.. 140512	47	40	54	141	173	70	SP.. 140512	225,00 €
	ATUM 48XD3 SP.. 140512	48	40	54	144	176	70	SP.. 140512	237,00 €
	ATUM 49XD3 SP.. 140512	49	40	54	147	179	70	SP.. 140512	248,00 €
	ATUM 50XD3 SP.. 140512	50	40	54	150	182	70	SP.. 140512	270,00 €
	ATUM 51XD3 SP.. 140512	51	40	54	153	185	70	SP.. 140512	282,00 €
	ATUM 52XD3 SP.. 140512	52	40	54	156	188	70	SP.. 140512	293,00 €
	COMPATIBLE WITH TGTC INSERT KOMPATIBEL FÜR WENDESCHNEIDPLATTEN TGTC								

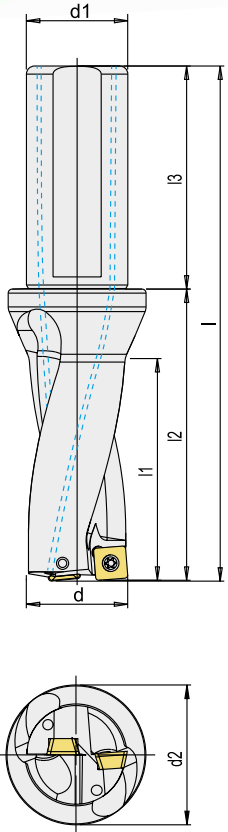
	CODE / TYP	TOOL DIMENSIONS (mm) <i>MAß</i>						CUTTING INSERT WENDE PLATTE	PRICE / PREIS
		d	d ₁	d ₂	l ₁	l ₂	l ₃		
D4  	ATUM 13XD4 SP.. 050204	13	20	25	52	74	50	SP.. 050204	259,00 €
	ATUM 14XD4 SP.. 050204	14	20	25	56	78	50	SP.. 050204	259,00 €
	ATUM 15XD4 SP.. 050204	15	20	25	60	82	50	SP.. 050204	259,00 €
	ATUM 16XD4 SP.. 060204	16	25	34	64	86	56	SP.. 060204	259,00 €
	ATUM 17XD4 SP.. 060204	17	25	34	68	90	56	SP.. 060204	259,00 €
	ATUM 17.5XD4 SP.. 060204	17.5	25	34	68	90	56	SP.. 060204	259,00 €
	ATUM 18XD4 SP.. 060204	18	25	34	72	94	56	SP.. 060204	259,00 €
	ATUM 19XD4 SP.. 060204	19	25	34	76	98	56	SP.. 060204	259,00 €
	ATUM 19.5XD4 SP.. 060204	19.5	25	34	76	98	56	SP.. 060204	259,00 €
	ATUM 20XD4 SP.. 060204	20	25	34	80	102	56	SP.. 060204	270,00 €
	ATUM 21XD4 SP.. 060204	21	25	34	84	106	56	SP.. 060204	270,00 €
	ATUM 22XD4 SP.. 07T308	22	25	34	88	110	56	SP.. 07T308	270,00 €
	ATUM 23XD4 SP.. 07T308	23	25	34	92	114	56	SP.. 07T308	270,00 €
	ATUM 23.5XD4 SP.. 07T308	23.5	25	34	92	114	56	SP.. 07T308	270,00 €
	ATUM 24XD4 SP.. 07T308	24	25	34	96	118	56	SP.. 07T308	282,00 €
	ATUM 25XD4 SP.. 07T308	25	25	34	100	122	56	SP.. 07T308	282,00 €
	ATUM 26XD4 SP.. 07T308	26	25	34	104	126	56	SP.. 07T308	282,00 €
	ATUM 27XD4 SP.. 07T308	27	25	34	108	130	56	SP.. 07T308	282,00 €
	ATUM 27.5XD4 SP.. 07T308	27.5	25	34	108	130	56	SP.. 07T308	282,00 €
	ATUM 28XD4 SP.. 090408	28	25	34	112	134	56	SP.. 090408	282,00 €
	ATUM 29XD4 SP.. 090408	29	25	34	116	138	56	SP.. 090408	282,00 €
	ATUM 30XD4 SP.. 090408	30	32	44	120	147	60	SP.. 090408	293,00 €
	ATUM 31XD4 SP.. 090408	31	32	44	124	151	60	SP.. 090408	293,00 €
	ATUM 32XD4 SP.. 090408	32	32	44	128	155	60	SP.. 090408	293,00 €
	ATUM 33XD4 SP.. 090408	33	32	44	132	159	60	SP.. 090408	293,00 €
	ATUM 33.5XD4 SP.. 090408	33.5	32	44	132	159	60	SP.. 090408	293,00 €
	ATUM 34XD4 SP.. 110408	34	32	44	136	163	60	SP.. 110408	293,00 €
	ATUM 35XD4 SP.. 110408	35	32	44	140	167	60	SP.. 110408	293,00 €
	ATUM 36XD4 SP.. 110408	36	32	44	144	171	60	SP.. 110408	293,00 €
	ATUM 37XD4 SP.. 110408	37	32	44	148	175	60	SP.. 110408	293,00 €
	ATUM 38XD4 SP.. 110408	38	32	44	152	179	60	SP.. 110408	293,00 €
	ATUM 39XD4 SP.. 110408	39	32	44	156	183	60	SP.. 110408	293,00 €
	ATUM 40XD4 SP.. 110408	40	32	44	160	187	60	SP.. 110408	293,00 €
	ATUM 41XD4 SP.. 110408	41	32	44	164	191	60	SP.. 110408	315,00 €
ATUM 42XD4 SP.. 140512	42	32	44	168	195	60	SP.. 140512	315,00 €	
ATUM 43XD4 SP.. 140512	43	32	44	172	199	60	SP.. 140512	315,00 €	
ATUM 44XD4 SP.. 140512	44	32	44	176	203	60	SP.. 140512	315,00 €	
COMPATIBLE WITH TGTC INSERT KOMPATIBEL FÜR WENDESCHNEIDPLATTEN TGTC									

U-DRILL SYSTEM / VOLLBOHRER (SPGT)

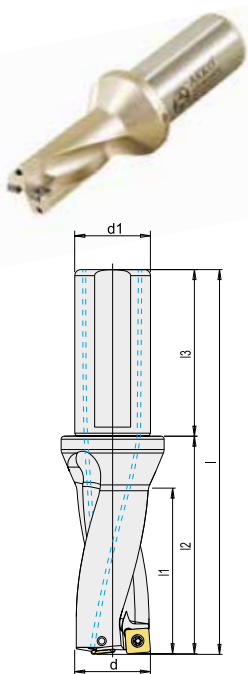
CODE / TYP	TOOL DIMENSIONS (mm) MAß						CUTTING INSERT WENDE PLATTE	PRICE / PREIS	
	d	d ₁	d ₂	l ₁	l ₂	l ₃			
D2  COMPATIBLE WITH ZCC INSERT KOMPATIBEL FÜR WENDESCHNEIDPLATTEN ZCC	ATUM 12.5XD2 SPGT 050204	12.5	20	25	24	46	50	SPGT 050204	147,00 €
	ATUM 13XD2 SPGT 050204	13	20	25	26	48	50	SPGT 050204	147,00 €
	ATUM 13.5XD2 SPGT 050204	13.5	20	25	26	48	50	SPGT 050204	147,00 €
	ATUM 14XD2 SPGT 050204	14	20	25	28	50	50	SPGT 050204	147,00 €
	ATUM 15XD2 SPGT 050204	15	20	25	30	52	50	SPGT 050204	147,00 €
	ATUM 16XD2 SPGT 060204	16	25	34	32	54	56	SPGT 060204	147,00 €
	ATUM 16.5XD2 SPGT 060204	16.5	25	34	32	54	56	SPGT 060204	147,00 €
	ATUM 17XD2 SPGT 060204	17	25	34	34	56	56	SPGT 060204	147,00 €
	ATUM 17.5XD2 SPGT 060204	17.5	25	34	34	56	56	SPGT 060204	147,00 €
	ATUM 18XD2 SPGT 060204	18	25	34	36	58	56	SPGT 060204	147,00 €
	ATUM 19XD2 SPGT 060204	19	25	34	38	60	56	SPGT 060204	147,00 €
	ATUM 20XD2 SPGT 060204	20	25	34	40	62	56	SPGT 060204	157,00 €
	ATUM 22XD2 SPGT 07T308	22	25	34	44	66	56	SPGT 07T308	157,00 €
	ATUM 22.5XD2 SPGT 07T308	22.5	25	34	44	66	56	SPGT 07T308	157,00 €
	ATUM 23XD2 SPGT 07T308	23	25	34	46	68	56	SPGT 07T308	157,00 €
	ATUM 24XD2 SPGT 07T308	24	25	34	48	70	56	SPGT 07T308	163,00 €
	ATUM 25XD2 SPGT 07T308	25	25	34	50	72	56	SPGT 07T308	163,00 €
	ATUM 26XD2 SPGT 07T308	26	25	34	52	74	56	SPGT 07T308	163,00 €
	ATUM 28XD2 SPGT 090408	28	25	34	56	78	56	SPGT 090408	163,00 €
	ATUM 29XD2 SPGT 090408	29	25	34	58	80	56	SPGT 090408	163,00 €
	ATUM 30XD2 SPGT 090408	30	32	44	60	87	60	SPGT 090408	174,00 €
	ATUM 32XD2 SPGT 090408	32	32	44	64	91	60	SPGT 090408	174,00 €
	ATUM 35XD2 SPGT 110408	35	32	44	70	97	60	SPGT 110408	174,00 €
	ATUM 36XD2 SPGT 110408	36	32	44	72	99	60	SPGT 110408	174,00 €
	ATUM 40XD2 SPGT 110408	40	32	44	80	107	60	SPGT 110408	174,00 €

CODE / TYP	TOOL DIMENSIONS (mm) MAß						CUTTING INSERT WENDE PLATTE	PRICE / PREIS	
	d	d ₁	d ₂	l ₁	l ₂	l ₃			
D4  COMPATIBLE WITH ZCC INSERT KOMPATIBEL FÜR WENDESCHNEIDPLATTEN ZCC	ATUM 13XD4 SPGT 050204	13	20	25	52	74	50	SPGT 050204	259,00 €
	ATUM 14XD4 SPGT 050204	14	20	25	56	78	50	SPGT 050204	259,00 €
	ATUM 15XD4 SPGT 050204	15	20	25	60	82	50	SPGT 050204	259,00 €
	ATUM 16XD4 SPGT 060204	16	25	34	64	86	56	SPGT 060204	259,00 €
	ATUM 17XD4 SPGT 060204	17	25	34	68	90	56	SPGT 060204	259,00 €
	ATUM 17.5XD4 SPGT 060204	17.5	25	34	68	90	56	SPGT 060204	259,00 €
	ATUM 18XD4 SPGT 060204	18	25	34	72	94	56	SPGT 060204	259,00 €
	ATUM 19XD4 SPGT 060204	19	25	34	76	98	56	SPGT 060204	259,00 €
	ATUM 19.5XD4 SPGT 060204	19.5	25	34	76	98	56	SPGT 060204	259,00 €
	ATUM 20XD4 SPGT 060204	20	25	34	80	102	56	SPGT 060204	270,00 €
	ATUM 21XD4 SPGT 060204	21	25	34	84	106	56	SPGT 060204	270,00 €
	ATUM 22XD4 SPGT 07T308	22	25	34	88	110	56	SPGT 07T308	270,00 €
	ATUM 23XD4 SPGT 07T308	23	25	34	92	114	56	SPGT 07T308	270,00 €
	ATUM 23.5XD4 SPGT 07T308	23.5	25	34	92	114	56	SPGT 07T308	270,00 €
	ATUM 24XD4 SPGT 07T308	24	25	34	96	118	56	SPGT 07T308	282,00 €
	ATUM 25XD4 SPGT 07T308	25	25	34	100	122	56	SPGT 07T308	282,00 €
	ATUM 26XD4 SPGT 07T308	26	25	34	104	126	56	SPGT 07T308	282,00 €
	ATUM 27.5XD4 SPGT 07T308	27.5	25	34	108	130	56	SPGT 07T308	282,00 €
	ATUM 28XD4 SPGT 090408	28	25	34	112	134	56	SPGT 090408	282,00 €
	ATUM 29XD4 SPGT 090408	29	25	34	116	138	56	SPGT 090408	282,00 €
	ATUM 30XD4 SPGT 090408	30	32	44	120	147	60	SPGT 090408	293,00 €
	ATUM 33.5XD4 SPGT 090408	33.5	32	44	132	159	60	SPGT 090408	293,00 €
	ATUM 38XD4 SPGT 110408	38	32	44	152	179	60	SPGT 110408	293,00 €

U-DRILL SYSTEM / VOLLBOHRER (SPGT)

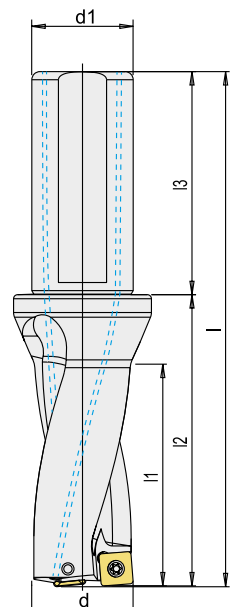
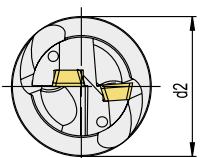
D3	CODE / TYP	TOOL DIMENSIONS (mm) <small>MAß</small>						CUTTING INSERT <small>WENDE PLATTE</small>	PRICE / PREIS
		d	d ₁	d ₂	l ₁	l ₂	l ₃		
	ATUM 12.5XD3 SPGT 050204	12,5	20	25	36	58	50	SPGT 050204	157,00 €
	ATUM 13XD3 SPGT 050204	13	20	25	39	61	50	SPGT 050204	157,00 €
	ATUM 13.5XD3 SPGT 050204	13,5	20	25	39	61	50	SPGT 050204	157,00 €
	ATUM 14XD3 SPGT 050204	14	20	25	42	64	50	SPGT 050204	157,00 €
	ATUM 14.5XD3 SPGT 050204	14,5	20	25	42	64	50	SPGT 050204	157,00 €
	ATUM 15XD3 SPGT 050204	15	20	25	45	67	50	SPGT 050204	157,00 €
	ATUM 15.5XD3 SPGT 060204	15,5	20	25	45	67	50	SPGT 060204	157,00 €
	ATUM 16XD3 SPGT 060204	16	25	34	48	70	56	SPGT 060204	157,00 €
	ATUM 16.5XD3 SPGT 060204	16,5	25	34	48	70	56	SPGT 060204	157,00 €
	ATUM 17XD3 SPGT 060204	17	25	34	51	73	56	SPGT 060204	157,00 €
	ATUM 17.5XD3 SPGT 060204	17,5	25	34	51	73	56	SPGT 060204	157,00 €
	ATUM 18XD3 SPGT 060204	18	25	34	54	76	56	SPGT 060204	157,00 €
	ATUM 18.5XD3 SPGT 060204	18,5	25	34	54	76	56	SPGT 060204	157,00 €
	ATUM 19XD3 SPGT 060204	19	25	34	57	79	56	SPGT 060204	157,00 €
	ATUM 19.5XD3 SPGT 060204	19,5	25	34	57	79	56	SPGT 060204	157,00 €
	ATUM 20XD3 SPGT 060204	20	25	34	60	82	56	SPGT 060204	163,00 €
	ATUM 20.5XD3 SPGT 060204	20,5	25	34	60	82	56	SPGT 060204	163,00 €
	ATUM 21XD3 SPGT 060204	21	25	34	63	85	56	SPGT 060204	163,00 €
	ATUM 21.5XD3 SPGT 060204	21,5	25	34	63	85	56	SPGT 060204	163,00 €
	ATUM 22XD3 SPGT 07T308	22	25	34	66	88	56	SPGT 07T308	163,00 €
	ATUM 22.5XD3 SPGT 07T308	22,5	25	34	66	88	56	SPGT 07T308	163,00 €
	ATUM 23XD3 SPGT 07T308	23	25	34	69	91	56	SPGT 07T308	163,00 €
	ATUM 23.5XD3 SPGT 07T308	23,5	25	34	69	91	56	SPGT 07T308	163,00 €
	ATUM 24XD3 SPGT 07T308	24	25	34	72	94	56	SPGT 07T308	169,00 €
	ATUM 24.5XD3 SPGT 07T308	24,5	25	34	72	94	56	SPGT 07T308	169,00 €
	ATUM 25XD3 SPGT 07T308	25	25	34	75	97	56	SPGT 07T308	169,00 €
	ATUM 25.5XD3 SPGT 07T308	25,5	25	34	75	97	56	SPGT 07T308	169,00 €
	ATUM 26XD3 SPGT 07T308	26	25	34	78	100	56	SPGT 07T308	169,00 €
	ATUM 26.5XD3 SPGT 07T308	26,5	25	34	78	100	56	SPGT 07T308	169,00 €
	ATUM 27XD3 SPGT 07T308	27	25	34	81	103	56	SPGT 07T308	169,00 €
	ATUM 27.5XD3 SPGT 07T308	27,5	25	34	81	103	56	SPGT 07T308	169,00 €
	ATUM 28XD3 SPGT 090408	28	25	34	84	106	56	SPGT 090408	169,00 €
	ATUM 28.5XD3 SPGT 090408	28,5	25	34	84	106	56	SPGT 090408	169,00 €
	ATUM 29XD3 SPGT 090408	29	25	34	87	109	56	SPGT 090408	169,00 €
	ATUM 29.5XD3 SPGT 090408	29,5	25	34	87	109	56	SPGT 090408	169,00 €
	ATUM 30XD3 SPGT 090408	30	32	44	90	117	60	SPGT 090408	174,00 €
	ATUM 31XD3 SPGT 090408	31	32	44	93	120	60	SPGT 090408	174,00 €
	ATUM 32XD3 SPGT 090408	32	32	44	96	123	60	SPGT 090408	174,00 €
	ATUM 33XD3 SPGT 090408	33	32	44	99	126	60	SPGT 090408	174,00 €
	ATUM 34XD3 SPGT 110408	34	32	44	102	129	60	SPGT 110408	174,00 €
	ATUM 35XD3 SPGT 110408	35	32	44	105	132	60	SPGT 110408	174,00 €
	ATUM 37XD3 SPGT 110408	37	32	44	111	138	60	SPGT 110408	174,00 €
	ATUM 38XD3 SPGT 110408	38	32	44	114	141	60	SPGT 110408	174,00 €
	ATUM 39XD3 SPGT 110408	39	32	44	117	144	60	SPGT 110408	174,00 €
	ATUM 40XD3 SPGT 110408	40	32	44	120	147	60	SPGT 110408	174,00 €
	ATUM 42XD3 SPGT 140512	42	32	44	126	153	60	SPGT 140512	192,00 €
	ATUM 43XD3 SPGT 140512	43	32	44	129	156	60	SPGT 140512	192,00 €
	ATUM 44XD3 SPGT 140512	44	32	44	132	159	60	SPGT 140512	192,00 €
	ATUM 49XD3 SPGT 140512	49	40	54	147	179	70	SPGT 140512	248,00 €
	ATUM 50XD3 SPGT 140512	50	40	54	150	182	70	SPGT 140512	270,00 €

COMPATIBLE WITH ZCC INSERT
KOMPATIBEL FÜR WENDESCHNEIDPLATTEN ZCC

U-DRILL SYSTEM / VOLLBOHRER (SOMX - SOMT)

D3	CODE / TYP	TOOL DIMENSIONS (mm) <i>MAß</i>						CUTTING INSERT WENDE PLATTE	PRICE / PREIS
		d	d ₁	d ₂	l ₁	l ₂	l ₃		
	ATUM 14XD3 SO.. 050204	14	20	25	42	64	50	SO.. 050204	157,00 €
	ATUM 15XD3 SO.. 050204	15	20	25	45	67	50	SO.. 050204	157,00 €
	ATUM 16XD3 SO.. 050204	16	25	34	48	70	56	SO.. 050204	157,00 €
	ATUM 16.5XD3 SO.. 050204	16.5	25	34	48	70	56	SO.. 050204	157,00 €
	ATUM 17XD3 SO.. 050204	17	25	34	51	73	56	SO.. 050204	157,00 €
	ATUM 17.5XD3 SO.. 050204	17.5	25	34	51	73	56	SO.. 050204	157,00 €
	ATUM 18XD3 SO.. 060304	18	25	34	54	76	56	SO.. 060304	157,00 €
	NEW ATUM 19XD3 SO.. 060204	19	25	34	57	79	56	SO.. 060204	157,00 €
	ATUM 20XD3 SO.. 060304	20	25	34	60	82	56	SO.. 060304	163,00 €
	ATUM 22XD3 SO.. 070305	22	25	34	66	88	56	SO.. 070305	163,00 €
	ATUM 22.5XD3 SO.. 070305	22.5	25	34	66	88	56	SO.. 070305	163,00 €
	ATUM 23XD3 SO.. 070305	23	25	34	69	91	56	SO.. 070305	163,00 €
	ATUM 24XD3 SO.. 070305	24	25	34	72	94	56	SO.. 070305	169,00 €
	ATUM 25XD3 SO.. 09T306	25	25	34	75	97	56	SO.. 09T306	169,00 €
	ATUM 26XD3 SO.. 09T306	26	25	34	78	100	56	SO.. 09T306	169,00 €
	NEW ATUM 27XD3 SO.. 09T306	27	25	34	81	103	56	SO.. 09T306	169,00 €
	NEW ATUM 29XD3 SO.. 09T306	29	25	34	87	109	56	SO.. 09T306	169,00 €
	ATUM 30XD3 SO.. 09T306	30	32	44	90	117	60	SO.. 09T306	174,00 €
	NEW ATUM 31XD3 SO.. 09T306	31	32	44	93	120	60	SO.. 09T306	174,00 €
	NEW ATUM 33XD3 SO.. 09T306	33	32	44	99	126	60	SO.. 09T306	174,00 €
	NEW ATUM 35XD3 SO.. 120408	35	32	44	105	132	60	SO.. 120408	174,00 €
	NEW ATUM 36XD3 SO.. 120408	36	32	44	108	135	60	SO.. 120408	174,00 €
	NEW ATUM 37XD3 SO.. 120408	37	32	44	111	138	60	SO.. 120408	174,00 €
	NEW ATUM 38XD3 SO.. 120408	38	32	44	114	141	60	SO.. 120408	174,00 €
	NEW ATUM 39XD3 SO.. 120408	39	32	44	117	144	60	SO.. 120408	174,00 €
	NEW ATUM 40XD3 SO.. 120408	40	32	44	120	147	60	SO.. 120408	174,00 €
	NEW ATUM 43XD3 SO.. 120408	43	32	44	129	156	60	SO.. 120408	193,00 €

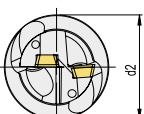
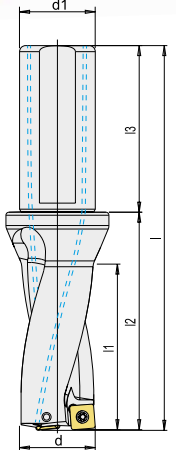



COMPATIBLE WITH ISCR INSERT
KOMPATIBEL FÜR WENDESCHNEIDPLATTEN ISCR

D4	CODE / TYP	TOOL DIMENSIONS (mm) <i>MAß</i>						CUTTING INSERT WENDE PLATTE	PRICE / PREIS
		d	d ₁	d ₂	l ₁	l ₂	l ₃		
	ATUM 14XD4 SO.. 050204	14	20	25	56	78	50	SO.. 050204	259,00 €
	ATUM 14.5XD4 SO.. 050204	14.5	20	25	56	78	50	SO.. 050204	259,00 €
	ATUM 15.5XD4 SO.. 050204	15.5	20	25	60	82	50	SO.. 050204	259,00 €
	ATUM 17XD4 SO.. 050204	17	25	34	68	90	56	SO.. 050204	259,00 €
	ATUM 19XD4 SO.. 060304	19	25	34	76	98	56	SO.. 060304	259,00 €
	ATUM 19.5XD4 SO.. 060304	19.5	25	34	76	98	56	SO.. 060304	259,00 €
	ATUM 20XD4 SO.. 060304	20	25	34	80	102	56	SO.. 060304	270,00 €
	ATUM 22XD4 SO.. 070305	22	25	34	88	110	56	SO.. 070305	270,00 €
	ATUM 22.5XD4 SO.. 070305	22.5	25	34	88	110	56	SO.. 070305	270,00 €
	NEW ATUM 23XD4 SO.. 070305	23	25	34	92	114	56	SO.. 070305	270,00 €
	NEW ATUM 24XD4 SO.. 070305	24	25	34	96	118	56	SO.. 070305	282,00 €
	NEW ATUM 25XD4 SO.. 09T306	25	25	34	100	122	56	SO.. 09T306	282,00 €
	NEW ATUM 27XD4 SO.. 09T306	27	25	34	108	130	56	SO.. 09T306	282,00 €
	NEW ATUM 28XD4 SO.. 09T306	28	25	34	112	134	56	SO.. 09T306	282,00 €
	NEW ATUM 29XD4 SO.. 09T306	29	25	34	116	138	56	SO.. 09T306	282,00 €
	NEW ATUM 30XD4 SO.. 09T306	30	32	44	120	147	60	SO.. 09T306	293,00 €
	NEW ATUM 31XD4 SO.. 09T306	31	32	44	124	151	60	SO.. 09T306	293,00 €
	NEW ATUM 33XD4 SO.. 09T306	33	32	44	132	159	60	SO.. 09T306	293,00 €
	NEW ATUM 34XD4 SO.. 09T306	34	32	44	136	163	60	SO.. 09T306	293,00 €
	NEW ATUM 35XD4 SO.. 120408	35	32	44	140	167	60	SO.. 120408	293,00 €

COMPATIBLE WITH ISCR INSERT
KOMPATIBEL FÜR WENDESCHNEIDPLATTEN ISCR

U-DRILL SYSTEM / VOLLBOHRER (SPMT - XOMT)

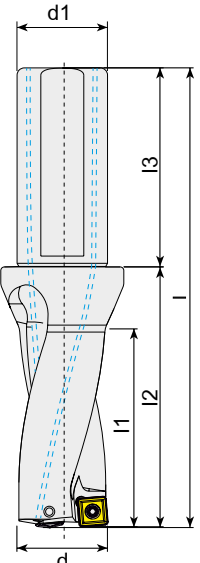
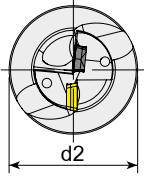
	CODE / TYP	TOOL DIMENSIONS (mm) <i>MAß</i>							CUTTING INSERT WENDE PLATTE	PRICE / PREIS
		d	d ₁	d ₂	l	l ₁	l ₂	l ₃		
D2  COMPATIBLE WITH KRLY INSERT KOMPATIBEL FÜR WENDESCHNEIDPLATTEN KRLY	ATUM 14XD2 KDR 0502..	14	20	25	100	28	50	50	SPMT 050204-XOMT 050204	147,00 €
	ATUM 18XD2 KDR 0602..	18	25	34	114	36	58	56	SPMT 060205-XOMT 060204	147,00 €
	ATUM 20XD2 KDR 07T2..	20	25	34	118	40	62	56	SPMT 07T208-XOMT 07T205	157,00 €
	ATUM 22XD2 KDR 07T2..	22	25	34	122	44	66	56	SPMT 07T208-XOMT 07T205	157,00 €
	ATUM 24XD2 KDR 0903..	24	25	34	126	48	70	56	SPMT 090308-XOMT 090305	163,00 €
	ATUM 25XD2 KDR 0903..	25	25	34	128	50	72	56	SPMT 090308-XOMT 090305	163,00 €
	ATUM 26XD2 KDR 0903..	26	25	34	130	52	74	56	SPMT 090308-XOMT 090305	163,00 €
	ATUM 28XD2 KDR 0903..	28	25	34	134	56	78	56	SPMT 090308-XOMT 090305	163,00 €
	ATUM 30XD2 KDR 11T3..	30	25	34	147	60	87	60	SPMT 11T308-XOMT 11T306	174,00 €
	ATUM 32XD2 KDR 11T3..	32	32	44	151	64	91	60	SPMT 11T308-XOMT 11T306	174,00 €
	ATUM 34XD2 KDR 11T3..	34	32	44	155	68	95	60	SPMT 11T308-XOMT 11T306	174,00 €
D3    COMPATIBLE WITH KRLY INSERT KOMPATIBEL FÜR WENDESCHNEIDPLATTEN KRLY	ATUM 12.5XD3 KDR 0402..	12.5	20	25	108	36	58	50	SPMT 040204-XOMT 040204	157,00 €
	ATUM 13XD3 KDR 0402..	13	20	25	111	39	61	50	SPMT 040204-XOMT 040204	157,00 €
	ATUM 14XD3 KDR 0502..	14	20	25	114	42	64	50	SPMT 050204-XOMT 050204	157,00 €
	ATUM 14.5XD3 KDR 0502..	14.5	20	25	114	42	64	50	SPMT 050204-XOMT 050204	157,00 €
	ATUM 15XD3 KDR 0502..	15	20	25	117	45	67	50	SPMT 050204-XOMT 050204	157,00 €
	ATUM 15.5XD3 KDR 0502..	15.5	20	25	117	45	67	50	SPMT 050204-XOMT 050204	157,00 €
	ATUM 16XD3 KDR 0502..	16	25	34	126	48	70	56	SPMT 050204-XOMT 050204	157,00 €
	ATUM 16.5XD3 KDR 0602..	16.5	25	34	126	48	70	56	SPMT 060205-XOMT 060204	157,00 €
	ATUM 17XD3 KDR 0602..	17	25	34	129	51	73	56	SPMT 060205-XOMT 060204	157,00 €
	ATUM 17.5XD3 KDR 0602..	17.5	25	34	129	51	73	56	SPMT 060205-XOMT 060204	157,00 €
	ATUM 18XD3 KDR 0602..	18	25	34	132	54	76	56	SPMT 060205-XOMT 060204	157,00 €
	ATUM 18.5XD3 KDR 0602..	18.5	25	34	132	54	76	56	SPMT 060205-XOMT 060204	157,00 €
	ATUM 19XD3 KDR 0602..	19	25	34	135	57	79	56	SPMT 060205-XOMT 060204	157,00 €
	ATUM 19.5XD3 KDR 0602..	19.5	25	34	135	57	79	56	SPMT 060205-XOMT 060204	157,00 €
	ATUM 20XD3 KDR 07T2..	20	25	34	138	60	82	56	SPMT 07T208-XOMT 07T205	163,00 €
	ATUM 20.5XD3 KDR 07T2..	20.5	25	34	138	60	82	56	SPMT 07T208-XOMT 07T205	163,00 €
	ATUM 21XD3 KDR 07T2..	21	25	34	141	63	85	56	SPMT 07T208-XOMT 07T205	163,00 €
	ATUM 22XD3 KDR 07T2..	22	25	34	144	66	88	56	SPMT 07T208-XOMT 07T205	163,00 €
	ATUM 23XD3 KDR 07T2..	23	25	34	147	69	91	56	SPMT 07T208-XOMT 07T205	163,00 €
	ATUM 23.5XD3 KDR 07T2..	23.5	25	34	147	69	91	56	SPMT 07T208-XOMT 07T205	163,00 €
	ATUM 24XD3 KDR 0903..	24	25	34	150	72	94	56	SPMT 090308-XOMT 090305	169,00 €
	ATUM 24.5XD3 KDR 0903..	24.5	25	34	150	72	94	56	SPMT 090308-XOMT 090305	169,00 €
	ATUM 25XD3 KDR 0903..	25	25	34	153	75	97	56	SPMT 090308-XOMT 090305	169,00 €
	ATUM 26XD3 KDR 0903..	26	25	34	156	78	100	56	SPMT 090308-XOMT 090305	169,00 €
	ATUM 27XD3 KDR 0903..	27	25	34	159	81	103	56	SPMT 090308-XOMT 090305	169,00 €
	ATUM 28XD3 KDR 0903..	28	25	34	162	84	106	56	SPMT 090308-XOMT 090305	169,00 €
	ATUM 29XD3 KDR 0903..	29	25	34	165	87	109	56	SPMT 090308-XOMT 090305	169,00 €
	ATUM 30XD3 KDR 11T3..	30	32	44	177	90	117	60	SPMT 11T308-XOMT 11T306	174,00 €
	ATUM 32XD3 KDR 11T3..	32	32	44	183	96	123	60	SPMT 11T308-XOMT 11T306	174,00 €
	ATUM 33XD3 KDR 11T3..	33	32	44	186	99	126	60	SPMT 11T308-XOMT 11T306	174,00 €
	ATUM 34XD3 KDR 11T3..	34	32	44	189	102	129	60	SPMT 11T308-XOMT 11T306	174,00 €
	ATUM 35XD3 KDR 11T3..	35	32	44	192	105	132	60	SPMT 11T308-XOMT 11T306	174,00 €
	ATUM 37XD3 KDR 1304..	37	32	44	198	111	138	60	SPMT 130410-XOMT 130406	174,00 €
	ATUM 38XD3 KDR 1304..	38	32	44	201	114	141	60	SPMT 130410-XOMT 130406	174,00 €
ATUM 39XD3 KDR 1304..	39	32	44	204	117	144	60	SPMT 130410-XOMT 130406	174,00 €	
ATUM 40XD3 KDR 1304..	40	32	44	207	120	147	60	SPMT 130410-XOMT 130406	174,00 €	

U-DRILL SYSTEM / VOLLBOHRER (SPMT - XOMT)

	CODE / TYP	TOOL DIMENSIONS (mm) <i>MAß</i>							CUTTING INSERT WENDE PLATTE	PRICE / PREIS
		d	d ₁	d ₂	l	l ₁	l ₂	l ₃		
 <p>D4</p> <p>COMPATIBLE WITH KRLY INSERT KOMPATIBEL FÜR WENDESCHNEIDPLATTEN KRLY</p>	ATUM 14XD4 KDR 0502..	14	20	25	128	56	78	50	SPMT 050204-XOMT 050204	259,00 €
	ATUM 14.5XD4 KDR 0502..	14.5	20	25	128	56	78	50	SPMT 050204-XOMT 050204	259,00 €
	ATUM 15XD4 KDR 0502..	15	20	25	132	60	82	50	SPMT 050204-XOMT 050204	259,00 €
	ATUM 15.5XD4 KDR 0502..	15.5	20	25	132	60	82	50	SPMT 050204-XOMT 050204	259,00 €
	ATUM 16XD4 KDR 0502..	16	25	34	142	64	86	56	SPMT 050204-XOMT 050204	259,00 €
	ATUM 17XD4 KDR 0602..	17	25	34	146	68	90	56	SPMT 060205-XOMT 060204	259,00 €
	ATUM 17.5XD4 KDR 0602..	17.5	25	34	146	68	90	56	SPMT 060205-XOMT 060204	259,00 €
	ATUM 18XD4 KDR 0602..	18	25	34	150	72	94	56	SPMT 060205-XOMT 060204	259,00 €
	ATUM 18.5XD4 KDR 0602..	18.5	25	34	150	72	94	56	SPMT 060205-XOMT 060204	259,00 €
	ATUM 19XD4 KDR 0602..	19	25	34	154	76	98	56	SPMT 060205-XOMT 060204	259,00 €
	ATUM 20XD4 KDR 07T2..	20	25	34	158	80	102	56	SPMT 07T208-XOMT 07T205	270,00 €
	ATUM 21XD4 KDR 07T2..	21	25	34	162	84	106	56	SPMT 07T208-XOMT 07T205	270,00 €
	ATUM 22XD4 KDR 07T2..	22	25	34	166	88	110	56	SPMT 07T208-XOMT 07T205	270,00 €
	ATUM 24XD4 KDR 0903..	24	25	34	174	96	118	56	SPMT 090308-XOMT 090305	282,00 €
ATUM 25XD4 KDR 0903..	25	25	34	178	100	122	56	SPMT 090308-XOMT 090305	282,00 €	

U-DRILL SYSTEM / VOLLBOHRER (SOMT)

	CODE / TYP	TOOL DIMENSIONS (mm) <i>MAß</i>							CUTTING INSERT WENDE PLATTE	PRICE / PREIS
		d	d ₁	d ₂	l	l ₁	l ₂	l ₃		
 <p>D2</p> <p>COMPATIBLE WITH TGTC INSERT KOMPATIBEL FÜR WENDESCHNEIDPLATTEN TGTC</p>	ATUM 14XD2 SOMT 050204	14	20	25	100	28	50	50	SOMT 050204	147,00 €
	ATUM 16XD2 SOMT 050204	16	25	34	110	32	54	56	SOMT 050204	147,00 €
	ATUM 17XD2 SOMT 060204	17	25	34	112	34	56	56	SOMT 060204	147,00 €
	ATUM 18XD2 SOMT 060204	18	25	34	114	36	58	56	SOMT 060204	147,00 €
	ATUM 20XD2 SOMT 070306	20	25	34	118	40	62	56	SOMT 070306	157,00 €
	ATUM 22XD2 SOMT 070306	22	25	34	122	44	66	56	SOMT 070306	157,00 €
	ATUM 24XD2 SOMT 08T306	24	25	34	126	48	70	56	SOMT 08T306	163,00 €
	ATUM 25XD2 SOMT 08T306	25	25	34	128	50	72	56	SOMT 08T306	163,00 €
	ATUM 26XD2 SOMT 08T306	26	25	34	130	52	74	56	SOMT 08T306	163,00 €
	ATUM 27XD2 SOMT 09T308	27	25	34	132	54	76	56	SOMT 09T308	163,00 €
	ATUM 28XD2 SOMT 09T308	28	25	34	134	56	78	56	SOMT 09T308	163,00 €
	ATUM 30XD2 SOMT 09T308	30	32	44	147	60	87	60	SOMT 09T308	174,00 €
	ATUM 32XD2 SOMT 11T308	32	32	44	151	64	91	60	SOMT 11T308	174,00 €
	ATUM 33XD2 SOMT 11T308	33	32	44	153	66	93	60	SOMT 11T308	174,00 €
	ATUM 34XD2 SOMT 11T308	34	32	44	155	68	95	60	SOMT 11T308	174,00 €
	ATUM 35XD2 SOMT 11T308	35	32	44	157	70	97	60	SOMT 11T308	174,00 €
	ATUM 37XD2 SOMT 130408	37	32	44	161	74	101	60	SOMT 130408	174,00 €
	ATUM 38XD2 SOMT 130408	38	32	44	163	76	103	60	SOMT 130408	174,00 €
	ATUM 40XD2 SOMT 130408	40	32	44	167	80	107	60	SOMT 130408	174,00 €
ATUM 45XD2 SOMT 150510	45	40	54	192	90	122	70	SOMT 150510	197,00 €	

User's Guide For U-Drills : P 114 / Bedienungsanleitung für U-Bohrer: S 114

Ordering Example/Beispiel Bestellformular: 1pcs. ATUM 14XD4 KDR 0502..



U-DRILL SYSTEM / VOLLBOHRER (SOMT)

D3	CODE / TYP	TOOL DIMENSIONS (mm) <i>MAß</i>						CUTTING INSERT WENDE PLATTE	PRICE / PREIS	
		d	d ₁	d ₂	l	l ₁	l ₂			l ₃
	ATUM 13XD3 SOMT 050204	13	20	25	111	39	61	50	SOMT 050204	157,00 €
	ATUM 14XD3 SOMT 050204	14	20	25	114	42	64	50	SOMT 050204	157,00 €
	ATUM 14.5XD3 SOMT 050204	14.5	20	25	114	42	64	50	SOMT 050204	157,00 €
	ATUM 15XD3 SOMT 050204	15	20	25	117	45	67	50	SOMT 050204	157,00 €
	ATUM 15.5XD3 SOMT 050204	15.5	20	25	117	45	67	50	SOMT 050204	157,00 €
	ATUM 16XD3 SOMT 050204	16	25	34	126	48	70	56	SOMT 050204	157,00 €
	ATUM 16.5XD3 SOMT 060204	16.5	25	34	126	48	70	56	SOMT 060204	157,00 €
	ATUM 17XD3 SOMT 060204	17	25	34	129	51	73	56	SOMT 060204	157,00 €
	ATUM 17.5XD3 SOMT 060204	17.5	25	34	129	51	73	56	SOMT 060204	157,00 €
	ATUM 18XD3 SOMT 060204	18	25	34	132	54	76	56	SOMT 060204	157,00 €
	ATUM 18.5XD3 SOMT 060204	18.5	25	34	132	54	76	56	SOMT 060204	157,00 €
	ATUM 19XD3 SOMT 060204	19	25	34	135	57	79	56	SOMT 060204	157,00 €
	ATUM 19.5XD3 SOMT 070306	19.5	25	34	135	57	79	56	SOMT 070306	157,00 €
	ATUM 20XD3 SOMT 070306	20	25	34	138	60	82	56	SOMT 070306	163,00 €
	ATUM 20.5XD3 SOMT 070306	20.5	25	34	138	60	82	56	SOMT 070306	163,00 €
	ATUM 21XD3 SOMT 070306	21	25	34	141	63	85	56	SOMT 070306	163,00 €
	ATUM 22XD3 SOMT 070306	22	25	34	144	66	88	56	SOMT 070306	163,00 €
	ATUM 22.5XD3 SOMT 08T306	22.5	25	34	144	66	88	56	SOMT 08T306	163,00 €
	ATUM 23XD3 SOMT 08T306	23	25	34	147	69	91	56	SOMT 08T306	163,00 €
	ATUM 23.5XD3 SOMT 08T306	23.5	25	34	147	69	91	56	SOMT 08T306	163,00 €
	ATUM 24XD3 SOMT 08T306	24	25	34	150	72	94	56	SOMT 08T306	169,00 €
	ATUM 24.5XD3 SOMT 08T306	24.5	25	34	150	72	94	56	SOMT 08T306	169,00 €
	ATUM 25XD3 SOMT 08T306	25	25	34	153	75	97	56	SOMT 08T306	169,00 €
	ATUM 26XD3 SOMT 08T306	26	25	34	156	78	100	56	SOMT 08T306	169,00 €
	ATUM 27XD3 SOMT 09T308	27	25	34	159	81	103	56	SOMT 09T308	169,00 €
	ATUM 27.5XD3 SOMT 09T308	27.5	25	34	159	81	103	56	SOMT 09T308	169,00 €
	ATUM 28XD3 SOMT 09T308	28	25	34	162	84	106	56	SOMT 09T308	169,00 €
	ATUM 29XD3 SOMT 09T308	29	25	34	165	87	109	56	SOMT 09T308	169,00 €
	ATUM 30XD3 SOMT 09T308	30	32	44	177	90	117	60	SOMT 09T308	174,00 €
	ATUM 32XD3 SOMT 11T308	32	32	44	183	96	123	60	SOMT 11T308	174,00 €
	ATUM 33XD3 SOMT 11T308	33	32	44	186	99	126	60	SOMT 11T308	174,00 €
	ATUM 34XD3 SOMT 11T308	34	32	44	189	102	129	60	SOMT 11T308	174,00 €
	ATUM 35XD3 SOMT 11T308	35	32	44	192	105	132	60	SOMT 11T308	174,00 €
	ATUM 36XD3 SOMT 11T308	36	32	44	195	108	135	60	SOMT 11T308	174,00 €
	ATUM 37XD3 SOMT 130408	37	32	44	198	111	138	60	SOMT 130408	174,00 €
	ATUM 38XD3 SOMT 130408	38	32	44	201	114	141	60	SOMT 130408	174,00 €
	ATUM 39XD3 SOMT 130408	39	32	44	204	117	144	60	SOMT 130408	174,00 €
	ATUM 40XD3 SOMT 130408	40	32	44	207	120	147	60	SOMT 130408	174,00 €
	ATUM 45XD3 SOMT 150510	45	40	54	237	135	167	70	SOMT 150510	202,00 €
	ATUM 49XD3 SOMT 150510	49	40	54	249	147	179	70	SOMT 150510	248,00 €
	ATUM 50XD3 SOMT 150510	50	40	54	252	150	182	70	SOMT 150510	270,00 €

COMPATIBLE WITH TGTC INSERT
KOMPATIBEL FÜR WENDESCHNEIDPLATTEN TGTC

D4	CODE / TYP	TOOL DIMENSIONS (mm) <i>MAß</i>						CUTTING INSERT WENDE PLATTE	PRICE / PREIS	
		d	d ₁	d ₂	l	l ₁	l ₂			l ₃
	ATUM 14XD4 SOMT 050204	14	20	25	128	56	78	50	SOMT 050204	259,00 €
	ATUM 14.5XD4 SOMT 050204	14.5	20	25	128	56	78	50	SOMT 050204	259,00 €
	ATUM 16XD4 SOMT 050204	16	25	34	142	64	86	56	SOMT 050204	259,00 €
	ATUM 17XD4 SOMT 060204	17	25	34	146	68	90	56	SOMT 060204	259,00 €
	ATUM 17.5XD4 SOMT 060204	17.5	25	34	146	68	90	56	SOMT 060204	259,00 €
	ATUM 18XD4 SOMT 060204	18	25	34	150	72	94	56	SOMT 060204	259,00 €
	ATUM 19XD4 SOMT 060204	19	25	34	154	76	98	56	SOMT 060204	259,00 €
	ATUM 20XD4 SOMT 070306	20	25	34	158	80	102	56	SOMT 070306	270,00 €
	ATUM 21XD4 SOMT 070306	21	25	34	162	84	106	56	SOMT 070306	270,00 €
	ATUM 22XD4 SOMT 070306	22	25	34	166	88	110	56	SOMT 070306	270,00 €
	ATUM 24XD4 SOMT 08T306	24	25	34	174	96	118	56	SOMT 08T306	282,00 €
	ATUM 25XD4 SOMT 08T306	25	25	34	178	100	122	56	SOMT 08T306	282,00 €

COMPATIBLE WITH TGTC INSERT
KOMPATIBEL FÜR WENDESCHNEIDPLATTEN TGTC

U-DRILL SYSTEM / VOLLBOHRER (SOMT)

	CODE / TYP	TOOL DIMENSIONS (mm) <i>MAß</i>						CUTTING INSERT <i>WENDE PLATTE</i>	PRICE / PREIS	
		d	d ₁	d ₂	l	l ₁	l ₂			l ₃
 <p>COMPATIBLE WITH TGTC INSERT KOMPATIBEL FÜR WENDESCHNEIDPLATTEN TGTC</p>	NEW ATUM 13XD5 SOMT 050204	13	20	25	137	65	87	50	SOMT 050204	275,00 €
	ATUM 14XD5 SOMT 050204	14	20	25	142	70	92	50	SOMT 050204	275,00 €
	ATUM 15XD5 SOMT 050204	15	20	25	147	75	97	50	SOMT 050204	275,00 €
	ATUM 15.5XD5 SOMT 050204	15.5	20	25	147	75	97	50	SOMT 050204	275,00 €
	ATUM 16XD5 SOMT 050204	16	25	34	158	80	102	56	SOMT 050204	275,00 €
	ATUM 17.5XD5 SOMT 060204	17	25	34	163	85	107	56	SOMT 060204	275,00 €
	ATUM 18XD5 SOMT 060204	18	25	34	168	90	112	56	SOMT 060204	275,00 €
	ATUM 19XD5 SOMT 060204	19	25	34	173	95	117	56	SOMT 060204	275,00 €
	ATUM 19.5XD5 SOMT 070306	19.5	25	34	173	95	117	56	SOMT 070306	275,00 €
	ATUM 20XD5 SOMT 070306	20	25	34	178	100	122	56	SOMT 070306	286,00 €
	ATUM 21XD5 SOMT 070306	21	25	34	183	105	127	56	SOMT 070306	286,00 €
	ATUM 22XD5 SOMT 070306	22	25	34	188	110	132	56	SOMT 070306	286,00 €
	ATUM 23XD5 SOMT 08T306	23	25	34	193	115	137	56	SOMT 08T306	286,00 €
	ATUM 24XD5 SOMT 08T306	24	25	34	198	120	142	56	SOMT 08T306	297,00 €
	ATUM 25XD5 SOMT 08T306	25	25	34	203	125	147	56	SOMT 08T306	297,00 €
	ATUM 26XD5 SOMT 08T306	26	25	34	208	130	152	56	SOMT 08T306	297,00 €
	ATUM 27XD5 SOMT 09T308	27	25	34	213	135	157	56	SOMT 09T308	297,00 €
	ATUM 28XD5 SOMT 09T308	28	25	34	218	140	162	56	SOMT 09T308	297,00 €
	ATUM 29XD5 SOMT 09T308	29	25	34	223	145	167	56	SOMT 09T308	297,00 €
	ATUM 30XD5 SOMT 09T308	30	32	44	237	150	177	60	SOMT 09T308	306,00 €
ATUM 33XD5 SOMT 11T308	33	32	44	252	165	192	60	SOMT 11T308	306,00 €	
ATUM 34XD5 SOMT 11T308	34	32	44	257	170	197	60	SOMT 11T308	306,00 €	
ATUM 35XD5 SOMT 11T308	35	32	44	262	175	202	60	SOMT 11T308	306,00 €	
ATUM 36XD5 SOMT 11T308	36	32	44	267	180	207	60	SOMT 11T308	306,00 €	

EXCENTRIC ADAPTOR FOR U-DRILLS / EXZENTRISCHER ADAPTER FÜR WENDEPLATTENBOHRER

	CODE / TYP	TOOL DIMENSIONS (mm) <i>MAß</i>			PRICE / PREIS
		d	D	L	
	AET-2025	20	25	44	72,00 €
	AET-2532	25	32	46	72,00 €
	AET-3240	32	40	55	72,00 €
CAN BE ADJUSTABLE BETWEEN		ZWISCHEN -0,2 mm UND +0,4 mm EINSTELLBAR			
Ø+0,4 - Ø-0,2 AS DECIMAL		BEISPIEL WERKZEUG :			
FOR EXAMPLE: Ø25 TOOL;		Ø25= WERKZEUG ZWISCHEN 24,80 ≈ 25,4 EINSTELLBAR			
CAN BE ADJUSTABLE BETWEEN 24,80 ≈ 25,4					

User's Guide For U-Drills : P 114 / Bedienungsanleitung für U-Bohrer: S 114

Ordering Example/Beispiel Bestellformular: 1pcs. ATUM 13XD5 SOMT 050204



DRILL CHAMFERING RING TOOLS / VOLLBOHRER RING FASENFRÄSER

	CODE / TYP	COMPATIBLE ATUM DIAMETER	CUTTING INSERT WENDE PLATTE	PRICE / PREIS
45°  	ADCR-120-VB1103	12.5	VBM. 1103..	79,00 €
	ADCR-125-VB1103	13	VBM. 1103..	79,00 €
	ADCR-130-VB1103	13.5	VBM. 1103..	79,00 €
	ADCR-135-VB1103	14	VBM. 1103..	79,00 €
	ADCR-140-VB1103	14.5	VBM. 1103..	79,00 €
	ADCR-145-VB1103	15	VBM. 1103..	79,00 €
	ADCR-150-VB1103	15.5-16	VBM. 1103..	79,00 €
	ADCR-155-VB1103	16.5	VBM. 1103..	79,00 €
	ADCR-160-VB1103	17	VBM. 1103..	83,00 €
	ADCR-165-VB1103	17.5	VBM. 1103..	83,00 €
	ADCR-170-VB1103	18	VBM. 1103..	83,00 €
	ADCR-175-VB1103	18.5	VBM. 1103..	83,00 €
	ADCR-180-VB1103	19	VBM. 1103..	83,00 €
	ADCR-185-VB1103	19.5	VBM. 1103..	83,00 €
	ADCR-190-VB1103	20	VBM. 1103..	83,00 €
	ADCR-195-VB1103	20.5	VBM. 1103..	83,00 €
	ADCR-200-VB1103	21	VBM. 1103..	87,00 €
	ADCR-205-VB1103	21.5	VBM. 1103..	87,00 €
	ADCR-210-VB1103	22	VBM. 1103..	87,00 €
	ADCR-215-VB1103	22.5	VBM. 1103..	87,00 €
	ADCR-220-VB1103	23	VBM. 1103..	87,00 €
	ADCR-225-VB1103	23.5	VBM. 1103..	87,00 €
	ADCR-230-VB1103	24	VBM. 1103..	87,00 €
	ADCR-235-VB1103	24.5	VBM. 1103..	87,00 €
	ADCR-240-VB1103	25	VBM. 1103..	87,00 €
	ADCR-245-VB1103	25.5	VBM. 1103..	87,00 €
	ADCR-250-VB1103	26	VBM. 1103..	94,00 €
	ADCR-255-VB1103	26.5	VBM. 1103..	94,00 €
	ADCR-260-VB1103	27	VBM. 1103..	94,00 €
	ADCR-265-VB1103	27.5	VBM. 1103..	94,00 €
	ADCR-270-VB1103	28	VBM. 1103..	94,00 €
	ADCR-275-VB1103	28.5	VBM. 1103..	94,00 €
	ADCR-280-VB1103	29	VBM. 1103..	94,00 €
ADCR-285-VB1103	29.5	VBM. 1103..	94,00 €	
ADCR-290-VB1103	30	VBM. 1103..	94,00 €	
ADCR-295-VB1103	30.5	VBM. 1103..	94,00 €	
ADCR-300-VB1103	31	VBM. 1103..	94,00 €	

DRILLING, BORING and EXTERNAL TURNING / MULTIFUNKTIONALES DREH-UND BOHRWERKZEUG

	CODE / TYP	TOOL DIMENSIONS (mm) MAß							CUTTING INSERT WENDE PLATTE	PRICE / PREIS
		ød	ød1	ød2	l1	l2	l3	f		
 COMPATIBLE WITH CRTZT-ISCR-TGTC-KRLY INSERT KOMPATIBEL FÜR WENDESCHNEIDPLATTEN CRTZT-ISCR-TGTC-KRLY	AEKL/R-D2.25X8 XC.. 040104	8	10	12	18	22	38	4	XC.. 040104	112,00 €
	AEKL/R-D2.25X10 XC.. 050204	10	12	16	22.5	27.5	42	5	XC.. 050204	112,00 €
	AEKL/R-D2.25X12 XC.. 060204	12	16	20	27	33	45	6	XC.. 060204	118,00 €
	AEKL/R-D2.25X14 XC.. 070304	14	16	20	31.5	38	45	7	XC.. 070304	123,00 €
	AEKL/R-D2.25X16 XC.. 080304	16	20	25	36	44	50	8	XC.. 080304	128,00 €
	AEKL/R-D2.25X18 XC.. 09T304	18	25	32	40.5	50	56	9	XC.. 09T304	144,00 €
	AEKL/R-D2.25X20 XC.. 10T304	20	25	32	45	55	56	10	XC.. 10T304	158,00 €
	AEKL/R-D2.25X25 XC.. 130404	25	32	40	56.5	69	60	12.5	XC.. 130404	179,00 €
	AEKL/R-D2.25X32 XC.. 170504	32	40	50	72	88	70	16	XC.. 170504	185,00 €

ROUGH BORING HEADS / SCHRUPP-SPINDELKOPF

	CODE / TYP	TOOL DIMENSIONS (mm) MAß						CARTRIDGE KURZDREHHALTER	PRICE / PREIS	
		Dmin / Dmax	D1	D2	D3	L	L1			L2
	ABHR-D18x22-W16-L90-CC06	18-22	16	-	-	90	42	-	AK.. 18-22	265,00 €
	ABHR-D18x22-W16-L150-CC06	18-22	16	-	-	150	102	-	AK.. 18-22	316,00 €
	ABHR-D18x22-W16-L200-CC06	18-22	16	-	-	200	152	-	AK.. 18-22	398,00 €
	ABHR-D22x28-W20-L100-CC06	22-28	20	-	-	100	50	-	AK.. 22-28	275,00 €
	ABHR-D22x28-W20-L150-CC06	22-28	20	-	-	150	100	-	AK.. 22-28	332,00 €
	ABHR-D22x28-W20-L200-CC06	22-28	20	-	-	200	150	-	AK.. 22-28	413,00 €
	ABHR-D28x38-W20-L110-CC06	28-38	20	25	-	110	60	-	AK.. 28-38	281,00 €
	ABHR-D28x38-W20-L160-CC06	28-38	20	25	-	160	110	-	AK.. 28-38	337,00 €
	ABHR-D28x38-W20-L230-CC06	28-38	20	25	-	230	180	-	AK.. 28-38	423,00 €
	ABHR-D36x50-W25-L120-CC06	36-50	25	32	-	120	64	-	AK.. 36-50	286,00 €
	ABHR-D36x50-W25-L170-CC06	36-50	25	32	-	170	114	-	AK.. 36-50	342,00 €
	ABHR-D36x50-W25-L250-CC06	36-50	25	32	-	250	194	-	AK.. 36-50	428,00 €
	ABHR-D36x50-W25-L120-CC09	36-50	25	32	-	120	64	-	AK.. 36-50-09	286,00 €
	ABHR-D36x50-W25-L170-CC09	36-50	25	32	-	170	114	-	AK.. 36-50-09	342,00 €
	ABHR-D36x50-W25-L250-CC09	36-50	25	32	-	250	194	-	AK.. 36-50-09	428,00 €
	ABHR-D50x68-W32-L140-CC09	50-68	32	40	-	140	80	-	AK.. 50-68	296,00 €
	ABHR-D50x68-W32-L200-CC09	50-68	32	40	-	200	140	-	AK.. 50-68	357,00 €
	ABHR-D50x68-W32-L280-CC09	50-68	32	40	-	280	220	-	AK.. 50-68	444,00 €
	ABHR-D50x68-W32-L140-CC12	50-68	32	40	-	140	80	-	AK.. 50-68-12	296,00 €
	ABHR-D50x68-W32-L200-CC12	50-68	32	40	-	200	140	-	AK.. 50-68-12	357,00 €
	ABHR-D50x68-W32-L280-CC12	50-68	32	40	-	280	220	-	AK.. 50-68-12	444,00 €
	ABHR-D68x90-W32-L160-CC12	68-90	32	50	54	160	100	50	AK.. 68-90	326,00 €
	ABHR-D68x90-W32-L210-CC12	68-90	32	50	54	210	150	50	AK.. 68-90	393,00 €
	ABHR-D68x90-W32-L280-CC12	68-90	32	50	54	280	220	50	AK.. 68-90	490,00 €
	ABHR-D90x120-W32-L140-CC12	90-120	32	63	72	140	80	63	AK.. 90-120	357,00 €
	ABHR-D90x120-W40-L200-CC12	90-120	40	63	72	200	130	63	AK.. 90-120	388,00 €
	ABHR-D90x120-W40-L300-CC12	90-120	40	63	72	300	230	63	AK.. 90-120	464,00 €
	ABHR-D120x160-W40-L210-CC12	120-160	40	80	95	210	140	75	AK.. 120-160	612,00 €
	ABHR-D120x160-W40-L300-CC12	120-160	40	80	95	300	230	75	AK.. 120-160	734,00 €
	ABHR-D160x200-W40-L210-B-CC12	160-200	40	80	95	210	140	75	AK.. 160-800	622,00 €
ABHR-D160x200-W40-L300-B-CC12	160-200	40	80	95	300	230	75	AK.. 160-800	744,00 €	

ADJUSTABLE ROUGH BORING HEADS BODY / TRÄGERWERKZEUG FÜR EINSTELLBARE SCHRUPP-BOHRKÖPFE

	CODE / TYP	TOOL DIMENSIONS (mm) MAß						CARTRIDGE KURZDREHHALTER	PRICE / PREIS	
		Dmin / Dmax	D1	D2	D3	L	L1			L2
	ABHRS-D16x42-W16-L90	18-22	16	-	-	90	42	-	AK.. 18-22	123,00 €
	ABHRS-D16x102-W16-L150	18-22	16	-	-	150	102	-	AK.. 18-22	174,00 €
	ABHRS-D16x152-W16-L200	18-22	16	-	-	200	152	-	AK.. 18-22	256,00 €
	ABHRS-D20x50-W20-L100	22-28	20	-	-	100	50	-	AK.. 22-28	121,00 €
	ABHRS-D20x100-W20-L150	22-28	20	-	-	150	100	-	AK.. 22-28	178,00 €
	ABHRS-D20x150-W20-L200	22-28	20	-	-	200	150	-	AK.. 28-38	259,00 €
	ABHRS-D25x60-W20-L110	28-38	20	25	-	110	60	-	AK.. 28-38	117,00 €
	ABHRS-D25x110-W20-L160	28-38	20	25	-	160	110	-	AK.. 28-38	173,00 €
	ABHRS-D25x180-W20-L230	28-38	20	25	-	230	180	-	AK.. 28-38	259,00 €
	ABHRS-D32x64-W25-L120	36-50	25	32	-	120	64	-	AK.. 36-50	112,00 €
	ABHRS-D32x114-W25-L170	36-50	25	32	-	170	114	-	AK.. 36-50	168,00 €
	ABHRS-D32x194-W25-L250	36-50	25	32	-	250	194	-	AK.. 36-50	254,00 €
	ABHRS-D40x80-W32-L140	50-68	32	40	-	140	80	-	AK.. 50-68	112,00 €
	ABHRS-D40x140-W32-L200	50-68	32	40	-	200	140	-	AK.. 50-68	173,00 €
	ABHRS-D40x220-W32-L280	50-68	32	40	-	280	220	-	AK.. 50-68	260,00 €
	ABHRS-D50x100-W32-L160	68-90	32	50	54	160	100	50	AK.. 68-90	132,00 €
	ABHRS-D50x150-W32-L210	68-90	32	50	54	210	150	50	AK.. 68-90	199,00 €
	ABHRS-D50x220-W32-L280	68-90	32	50	54	280	220	50	AK.. 68-90	296,00 €
	ABHRS-D63x80-W32-L140	90-120	32	63	72	140	80	63	AK.. 90-120	153,00 €
	ABHRS-D63x130-W40-L200	90-120	40	63	72	200	130	63	AK.. 90-120	184,00 €
	ABHRS-D63x230-W40-L300	90-120	40	63	72	300	230	63	AK.. 90-120	260,00 €
	ABHRS-D80x140-W40-L210	120-160	40	80	95	210	140	75	AK.. 120-160	398,00 €
	ABHRS-D80x230-W40-L300	120-160	40	80	95	300	230	75	AK.. 120-160	520,00 €
	ABHRS-D80x140-W40-L210	160-200	40	80	95	210	140	75	AK.. 160-800	398,00 €
	ABHRS-D80x230-W40-L300	160-200	40	80	95	300	230	75	AK.. 160-800	520,00 €

When ordered, body and cartridge will be sent as set.

Ordering Example/Beispiel Bestellformular: 1pcs. ABHR-D18x22-W16-L90-CC06

ROUGH BORING HEADS CARTRIDGE / SCHRUPP-SPINDELKOPF KURZDREHHALTER

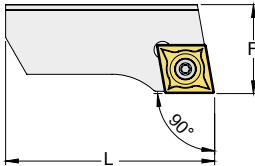
	CODE / TYP	TOOL DIMENSIONS (mm) <small>MAß</small>			CUTTING INSERT WENDE PLATTE	PRICE / PREIS
		D _{min} / D _{max}	F	L		
 	AKSR 18-22	18-22	9	15	CC.. 0602..	71,00 €
	AKSR 22-28	22-28	10	19	ISO	77,00 €
	AKSR 28-38	28-38	13	23		82,00 €
	AKSR 36-50	36-50	16	32		87,00 €
	AKSR 36-50-09	36-50	16	32	CC.. 09T3..	87,00 €
	AKSR 50-68	50-68	20	40	ISO	92,00 €
	AKSR 50-68-12	50-68	20	40	CC.. 1204..	92,00 €
	AKSR 68-90	68-90	23	54	ISO	97,00 €
	AKSR 90-120	90-120	28	70		102,00 €
	AKSR 120-160	120-160	33	95		107,00 €
AKSR 160-800	160-800	33	130		112,00 €	

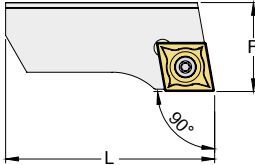
	CODE / TYP	TOOL DIMENSIONS (mm) <small>MAß</small>			CUTTING INSERT WENDE PLATTE	PRICE / PREIS
		D _{min} / D _{max}	F	L		
 	AKCR 28-38	28-38	12.8	23	CC.. 0602..	82,00 €
	AKCR 36-50	36-50	15.8	32	ISO	87,00 €
	AKCR 36-50-09	36-50	15.8	32	CC.. 09T3..	87,00 €
	AKCR 50-68	50-68	19.7	40	ISO	92,00 €
	AKCR 50-68-12	50-68	19.7	40	CC.. 1204..	92,00 €
	AKCR 68-90	68-90	22.7	54	ISO	97,00 €
	AKCR 90-120	90-120	27.7	70		102,00 €
	AKCR 120-160	120-160	32.7	95		107,00 €
	AKCR 160-800	160-800	32.7	130		112,00 €

HELIX CHAMFER MILLING TOOLS / HELIX-FASFRÄSE

	CODE / TYP	Z		TOOL DIMENSIONS (mm) <small>MAß</small>						PRICE / PREIS
		Total	Effective	α	d _a	D	d	a	L	
	AHM15-AP16-D35x93-A27-Z0306-H	6	3	15	35	93	27	8	50	350,00 €
	AHM30-AP16-D35x87-A27-Z0306-H	6	3	30	35	87	27	15	50	350,00 €
	AHM45-AP16-D35x77-A27-Z0306-H	6	3	45	35	77	27	21.5	50	350,00 €
	AHM60-AP16-D35x65-A22-Z0306-H	6	3	60	35	65	22	26.5	50	350,00 €
	AHM75-AP16-D35x50-A22-Z0306-H	6	3	75	35	50	22	29.5	50	350,00 €

**COUNTERSINK MILLING TOOL FOR CYLINDRICAL ALLEN HEAD SCREWS (DIN 974-1)
SENKWERKZEUG FÜR ZYLINDERKOPFSCHRAUBEN (DIN 974-1)**

	CODE / TYP	TOOL DIMENSIONS (mm) <small>MAß</small>						PRICE / PREIS
		d _a	D	d	I	L	For Screws	
	ACBM-CC06-D17X6-W16-L150-Z02	6	17	16	30	150	M10	102,00 €
	ACBM-CC06-D18X7-W16-L100-Z02-H	7	18	16	32	100	M10	82,00 €
	ACBM-CC06-D18X7-W16-L160-Z02-H	7	18	16	32	160	M10	109,00 €
	ACBM-CC06-D20X9-W20-L100-Z02-H	9	20	20	40	100	M12	87,00 €
	ACBM-CC06-D20X9-W20-L160-Z02-H	9	20	20	38	160	M12	116,00 €
	ACBM-CC09-D26X8.5-W25-L130-Z02-H	8.5	26	25	50	130	M16	92,00 €
	ACBM-CC09-D26X8.5-W25-L200-Z02	8.5	26	25	50	200	M16	123,00 €
	ACBM-CC09-D33X15.5-W32-L130-Z02-H	15.5	33	32	65	130	M20	102,00 €
	ACBM-CC09-D33X15.5-W32-L200-Z02	15.5	33	32	65	200	M20	139,00 €
	ACBM-SP06-D15X4-W16-L160-Z02-H	4	15	16	80	160	M8	109,00 €

CHAMFERING TOOLS / FASENFRÄSER

	CODE / TYP	TOOL DIMENSIONS (mm) MAß						CUTTING INSERT WENDE PLATTE	PRICE / PREIS	
		α	d_a	D	d	L	l			a
	ACM10-TC16-D17X22-W16-L90-Z01	10°	17	22	16	90	30	15.2	56,00 €	
	ACM15-TC16-D17X24-W16-L90-Z01	15°	17	24	16	90	30	14.9	56,00 €	
	ACM15-TC16-D22X29-W16-L100-Z01	15°	22	29	16	100	30	14.9	56,00 €	
	ACM15-TC16-D30X37-W20-L100-Z02	15°	30	37	20	100	35	14.9	82,00 €	
	ACM15-TC16-D35X42-W20-L100-Z03	15°	35	42	20	100	38	14.9	92,00 €	
	ACM15-TC16-D52X59-W25-L110-Z03	15°	52	59	25	110	40	14.9	92,00 €	
	ACM17.5-TC16-D17X25-W16-L90-Z01	17.5°	17	25	16	90	30	14.7	56,00 €	
	ACM18.5-TC16-D21.3X30-W20-L100-Z02	18.5°	21.3	30	20	100	30	13.5	56,00 €	
	ACM20-TC16-D12X22-W16-L100-Z01	20°	12	22	16	100	30	14.4	56,00 €	
	ACM20-TC16-D17X27-W16-L100-Z01	20°	17	27	16	100	30	14.4	56,00 €	
	ACM20-TC16-D23X33-W20-L100-Z02	20°	23	33	20	100	30	14.4	82,00 €	
	ACM20-TC16-D28X38-W20-L100-Z02	20°	28	38	20	100	35	14.4	TC.T 16T304	82,00 €
	ACM20-TC16-D35X45-W20-L100-Z03	20°	35	45	20	100	40	14.4	ISO	92,00 €
	ACM20-TC16-D39X49-W20-L100-Z03	20°	39	49	20	100	40	14.4		92,00 €
	ACM20-TC16-D45X55-W25-L110-Z03	20°	45	55	25	110	40	14.4		92,00 €
	ACM20-TC16-D51X61-W25-L110-Z03	20°	51	61	25	110	40	14.4		92,00 €
	ACM22.5-TC16-D17X28-W16-L100-Z01	22.5°	17	28	16	100	30	14.2		56,00 €
	ACM25-TC16-D17X29-W16-L100-Z01	25°	17	29	16	100	30	13.9		56,00 €
	ACM30-TC16-D6X20-W16-L100-Z01	30°	6	20	16	100	30	13.3		56,00 €
	ACM30-TC16-D15X30-W16-L100-Z01	30°	15	30	16	100	30	13.3		56,00 €
	ACM30-TC16-D17.5X32.5-W20-L100-Z02	30°	17.5	32.5	20	100	30	13.3		56,00 €
	ACM30-TC16-D20X35-W16-L100-Z02	30°	20	35	16	100	35	13.3		56,00 €
	ACM30-TC16-D30X45-W20-L100-Z02	30°	30	45	20	100	40	13.3		56,00 €
	ACM30-TC16-D35X50-W20-L100-Z03	30°	35	50	20	100	40	13.3		92,00 €
	ACM30-TC16-D45X60-W25-L110-Z03	30°	45	60	25	110	40	13.3		92,00 €
	ACM45-TC09-D7X18-W16-L100-Z02	45°	7	18	16	100	25	5.9	TC.T 090204	56,00 €
	ACM45-TC11-D11X24-W16-L100-Z02	45°	11	24	16	100	25	6.9	TC.T 110204	56,00 €
	ACM45-TC16-D5X26-W16-L100-Z01	45°	5	26	16	100	30	10.8		56,00 €
	ACM45-TC16-D10X31-W16-L100-Z02	45°	10	31	16	100	35	10.8		56,00 €
	ACM45-TC16-D10X31-W20-L100-Z02	45°	10	31	20	100	35	10.8		56,00 €
	ACM45-TC16-D18X39-W16-L100-Z02	45°	18	39	16	100	40	10.8		56,00 €
	ACM45-TC16-D18X39-W20-L100-Z02	45°	18	39	20	100	40	10.8	TC.T 16T304	56,00 €
	ACM45-TC16-D20X41-W20-L100-Z02	45°	20	41	20	100	40	10.8	ISO	56,00 €
ACM45-TC16-D30X51-W20-L100-Z02	45°	30	51	20	100	40	10.8		56,00 €	
ACM55-TC16-D16X40-W20-L100-Z03	55°	16	40	20	100	40	8.7		92,00 €	
ACM62-TC16-D14X40-W20-L100-Z03	62°	14	40	20	100	40	7.1		92,00 €	
ACM72-TC16-D14X42-W20-L100-Z03	72°	14	42	20	100	40	4.6		92,00 €	
	ACM45-SP1104-D12x26-W20-L150-Z01	45°	12	26	20	150	30	-	SPGT 110408	69,00 €
	ACM45-SP1104-D25x39-W25-L150-Z02	45°	25	39	25	150	35	-	FOR ZCC	87,00 €
	ACM45-SP1104-D32x46-W32-L150-Z03	45°	32	46	32	150	40	-	INSERT.	104,00 €

END MILLS / WP - SCHAFTFRÄSER





	CODE / TYP	TOOL DIMENSIONS (mm) MAß						CUTTING INSERT WENDE PLATTE	PRICE / PREIS
		D	Z	d	L	l	a		
	AEM90-AD07-D10-C10-L80-Z02-H	10	2	10	80	16	6	ADMX 0702..	108,00 €
	AEM90-AD07-D12-C12-L90-Z03-H	12	3	12	90	18	6	FOR PRMT	133,00 €
	AEM90-AD07-D16-C16-L110-Z04-H	16	4	16	110	19	6	INSERT.	171,00 €
	AEM90-AD07-D20-C20-L125-Z05-H	20	5	20	125	20	6		214,00 €
	AEM90-AD07-D25-C25-L140-Z06-H	25	6	25	14	24	6		260,00 €

90°

END MILLS / WP - SCHAFTFRÄSER

	CODE / TYP	TOOL DIMENSIONS (mm) <i>MAß</i>						CUTTING INSERT WENDE PLATTE	PRICE / PREIS
		D	Z	d	L	l	a		
 90°	AEM90-AD1505-D25-W25-L150-Z02	25	2	25	150	50	15	AD.. 1505..	106,00 €
	AEM90-AD1505-D30-W25-L150-Z03	30	3	25	150	50	15	FOR ISCR	121,00 €
	AEM90-AD1505-D32-W32-L150-Z03	32	3	32	150	50	15	INSERT.	121,00 €
 90°	AEM90-AD0803-D16-W16-L150-Z02	16	2	16	150	30	8		87,00 €
	AEM90-AD0803-D17-W16-L150-Z02	17	2	16	150	30	8	ADMT 0803..	87,00 €
	AEM90-AD0803-D17-W16-L200-Z02	17	2	16	200	30	8	FOR WLTR	123,00 €
	AEM90-AD0803-D20-W20-L150-Z03	20	3	20	150	30	8	INSERT.	104,00 €
	AEM90-AD0803-D21-W20-L200-Z03	21	3	20	200	30	8		165,00 €
	AEM90-AD10T3-D16-W16-L100-Z02-H	16	2	16	100	30	10		87,00 €
	AEM90-AD10T3-D16-W16-L150-Z02	16	2	16	150	40	10		87,00 €
	AEM90-AD10T3-D16-C16-L200-Z02	16	2	16	200	50	10		123,00 €
	AEM90-AD10T3-D17-W16-L150-Z02	17	2	16	150	30	10		87,00 €
	AEM90-AD10T3-D17-W16-L200-Z02	17	2	16	200	30	10		123,00 €
	AEM90-AD10T3-D20-W20-L70-Z03	20	3	20	70	30	10	ADMT 10T3..	94,00 €
	AEM90-AD10T3-D20-W20-L100-Z03-H	20	3	20	100	30	10	FOR WLTR	104,00 €
	AEM90-AD10T3-D20-W20-L150-Z03	20	3	20	150	30	10	INSERT.	104,00 €
	AEM90-AD10T3-D20-C20-L150-Z03	20	3	20	150	40	10		104,00 €
	AEM90-AD10T3-D20-C20-L200-Z03	20	3	20	200	40	10		170,00 €
	AEM90-AD10T3-D25-W25-L100-Z03-H	25	3	25	100	30	10		108,00 €
	AEM90-AD10T3-D25-W25-L100-Z04-H	25	4	25	100	30	10		129,00 €
	AEM90-AD10T3-D25-W25-L150-Z03	25	3	25	150	50	10		108,00 €
	AEM90-AD1204-D20-W20-L150-Z02	20	2	20	150	50	12		94,00 €
	☞ AEM90-AD1204-D21-C20-L150-Z02	21	2	20	150	30	12	ADMT 1204..	94,00 €
	☞ AEM90-AD1204-D22-C20-L150-Z02	22	2	20	150	30	12	FOR WLTR	94,00 €
	AEM90-AD1204-D25-W25-L150-Z03	25	3	25	150	50	12	INSERT.	110,00 €
	AEM90-AD1204-D26-W25-L180-Z03	26	3	25	180	35	12		154,00 €
	AEM90-AD1204-D32-W32-L150-Z04	32	4	32	150	50	12		125,00 €
	AEM90-AD1606-D25-W25-L150-Z02	25	2	25	150	50	15	ADMT 1606..	110,00 €
	AEM90-AD1606-D32-W32-L150-Z03	32	3	32	150	50	15	FOR WLTR	125,00 €
								INSERT.	
	 90°	AEM90-AD1003-D16-C16-L150-Z02	16	2	16	150	30	8	
AEM90-AD1003-D17-C16-L150-Z02		17	2	16	150	25	8		87,00 €
AEM90-AD1003-D20-C20-L200-Z03		20	3	20	200	50	8	ADMT 1003..	158,00 €
☞ AEM90-AD1003-D21-C20-L150-Z03		21	3	20	150	25	8	FOR DJT	97,00 €
AEM90-AD1003-D21-C20-L200-Z03		21	3	20	200	25	8	INSERT.	158,00 €
AEM90-AD1003-D25-C25-L200-Z03		25	3	25	200	50	8		168,00 €
AEM90-AD1003-D26-C25-L150-Z03		26	3	25	150	30	8		97,00 €
AEM90-AD1003-D26-C25-L200-Z03		26	3	25	200	30	8		155,00 €
AEM90-AD1505D-D25-W25-L150-Z02		25	2	25	150	50	14.3	ADKT 150508	106,00 €
AEM90-AD1505D-D32-W32-L150-Z03		32	3	32	150	50	14.3	FOR DJT	121,00 €
							INSERT.		
 90°	AEM90-AN11-D22-W20-L150-Z02	22	2	20	150	30	11		114,00 €
	AEM90-AN11-D25-W25-L150-Z02	25	2	25	150	40	11		100,00 €
	AEM90-AN11-D25-C25-L200-Z02	25	2	25	200	40	11		150,00 €
	AEM90-AN11-D26-W25-L150-Z02	26	2	25	150	40	11	ANGX 110508	120,00 €
	AEM90-AN11-D28-W25-L150-Z02	28	2	25	150	25	11	FOR ZCC	120,00 €
	AEM90-AN11-D32-W32-L150-Z03	32	3	32	150	50	11	INSERT.	116,00 €
	AEM90-AN11-D32-C32-L200-Z03	32	3	32	200	50	11		174,00 €
	AEM90-AN11-D40-W32-L150-Z04	40	4	32	150	40	11		133,00 €

END MILLS / WP - SCHAFTFRÄSER

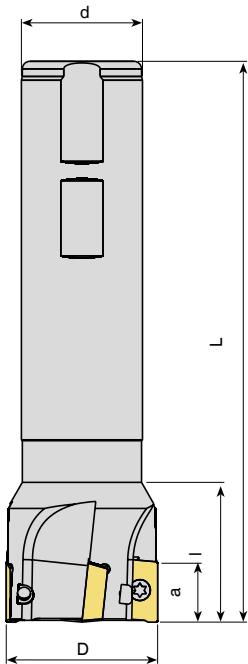
	CODE / TYP	TOOL DIMENSIONS (mm) <i>MAB</i>						CUTTING INSERT WENDE PLATTE	PRICE / PREIS
		D	Z	d	L	l	a		
  <p>90°</p>	AEM90-AN1207-D25-W25-L150-Z02	25	2	25	150	40	10	ANKX 1207..	114,00 €
	AEM90-AN1207-D32-W32-L150-Z03	32	3	32	150	50	10	FOR XTC-GSC	116,00 €
	AEM90-AN1207-D40-W32-L150-Z04	40	4	32	150	40	10	INSERT.	133,00 €
 <p>90°</p>	AEM90-AN1607-D32-C25-L150-Z02	32	2	25	150	40	15	AN.X 1607..	123,00 €
	AEM90-AN1607-D40-C32-L150-Z03	40	3	32	150	45	15	FOR TGTC INSERT.	155,00 €
 	AEM90-AP06-D10-C10-L120-Z02	10	2	10	120	20	5.6	APMT 0602..	119,00 €
	AEM90-AP06-D12-C12-L120-Z02	12	2	12	120	20	5.6	FOR KRLY INSERT.	119,00 €
	AEM90-AP0903-D16-C16-L150-Z02	16	2	16	150	30	9		97,00 €
	AEM90-AP0903-D17-C16-L150-Z02	17	2	16	150	30	9	APMT 0903..	97,00 €
	AEM90-AP0903-D20-C20-L150-Z02	20	2	20	150	30	9	FOR KRLY	107,00 €
	AEM90-AP0903-D21-C20-L150-Z02	21	2	20	150	30	9	INSERT.	107,00 €
	AEM90-AP0903-D25-C25-L150-Z03	25	3	25	150	30	9		117,00 €
	AEM90-AP09-D16-C16-L100-Z02-H	16	2	16	100	30	8.8		79,00 €
	AEM90-AP09-D16-C15-L150-Z02	16	2	15	150	25	8.8		97,00 €
	AEM90-AP09-D16-W16-L150-Z02-H	16	2	16	150	25	8.8		89,00 €
	AEM90-AP09-D16-C16-L200-Z02-H	16	2	16	200	100	8.8	APKT 09T3..	159,00 €
	AEM90-AP09-D17-C16-L150-Z02	17	2	16	150	25	8.8	FOR TGTC	97,00 €
	AEM90-AP09-D17-C16-L180-Z02-H	17	2	16	180	25	8.8	INSERT.	150,00 €
	AEM90-AP09-D20-C20-L150-Z03-H	20	3	20	150	50	8.8		102,00 €
	AEM90-AP09-D20-C20-L200-Z03-H	20	3	20	200	100	8.8		171,00 €
	AEM90-AP09-D20-C20-L250-Z02-H	20	2	20	250	150	8.8		255,00 €
	AEM90-AP09-D21-C20-L150-Z03	21	3	20	150	25	8.8		113,00 €
	AEM90-AP09-D26-C25-L150-Z04	26	4	25	150	30	8.8		129,00 €
	AEM90-AP10-D12-W16-L100-Z01-H	12	1	16	100	30	10		67,00 €
	AEM90-AP10-D12-W16-L150-Z01	12	1	16	150	38	10		67,00 €
	AEM90-AP10-D14-W16-L100-Z01-H	14	1	16	100	30	10		67,00 €
	AEM90-AP10-D14-W16-L150-Z01	14	1	16	150	38	10		67,00 €
	AEM90-AP10-D16-C16-L100-Z02-H	16	2	16	100	30	10		79,00 €
	AEM90-AP10-D16-W16-L100-Z02-H	16	2	16	100	30	10	AP. 1003..	79,00 €
	AEM90-AP10-D16-C16-L120-Z02-H	16	2	16	120	30	10	ISO	79,00 €
	AEM90-AP10-D16-C16-L150-Z02	16	2	16	150	50	10		79,00 €
	AEM90-AP10-D16-C16-L150-Z02-H	16	2	16	150	50	10		89,00 €
	AEM90-AP10-D16-W16-L150-Z02	16	2	16	150	50	10		79,00 €
	AEM90-AP10-D16-C16-L200-Z02	16	2	16	200	100	10		112,00 €
	AEM90-AP10-D16-C16-L200-Z02-H	16	2	16	200	100	10		140,00 €
AEM90-AP10-D16-C16-L250-Z02	16	2	16	250	50	10		189,00 €	
AEM90-AP10-D18-W16-L100-Z02-H	18	2	16	100	30	10		81,00 €	
AEM90-AP10-D18-W16-L150-Z02	18	2	16	150	30	10		81,00 €	
AEM90-AP10-D20-C20-L100-Z03-H	20	3	20	100	30	10		91,00 €	

END MILLS / WP - SCHAFTFRÄSER

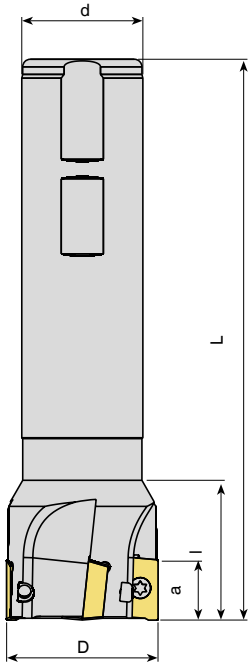
	CODE / TYP	TOOL DIMENSIONS (mm) <i>MAß</i>						CUTTING INSERT WENDE PLATTE	PRICE / PREIS
		D	Z	d	L	l	a		
  90°	AEM90-AP10-D20-W20-L100-Z03-H	20	3	20	100	30	10		91,00 €
	AEM90-AP10-D20-C20-L120-Z03-H	20	3	20	120	30	10		91,00 €
	AEM90-AP10-D20-C20-L150-Z03	20	3	20	150	50	10		91,00 €
	AEM90-AP10-D20-C20-L150-Z03-H	20	3	20	150	50	10		102,00 €
	AEM90-AP10-D20-W20-L150-Z03	20	3	20	150	50	10		91,00 €
	AEM90-AP10-D20-C20-L200-Z02	20	2	20	200	100	10		140,00 €
	AEM90-AP10-D20-C20-L200-Z03-H	20	3	20	200	100	10		171,00 €
	AEM90-AP10-D20-C20-L250-Z02	20	2	20	250	150	10		200,00 €
	AEM90-AP10-D20-C20-L250-Z02-H	20	2	20	250	150	10		255,00 €
	AEM90-AP10-D21-W20-L150-Z03	21	3	20	150	30	10		91,00 €
	AEM90-AP10-D22-W20-L100-Z03-H	22	3	20	100	30	10		91,00 €
	AEM90-AP10-D22-W20-L150-Z03	22	3	20	150	30	10		91,00 €
	AEM90-AP10-D23-W20-L150-Z03	23	3	20	150	30	10		91,00 €
	AEM90-AP10-D24-W20-L150-Z03	24	3	20	150	30	10		91,00 €
	AEM90-AP10-D25-W25-L100-Z04-H	25	4	25	100	30	10		117,00 €
	AEM90-AP10-D25-C25-L100-Z03-H	25	3	25	100	30	10	AP.. 1003..	97,00 €
	AEM90-AP10-D25-W25-L100-Z03-H	25	3	25	100	30	10	ISO	97,00 €
	AEM90-AP10-D25-C25-L120-Z03-H	25	3	25	120	30	10		91,00 €
	AEM90-AP10-D25-C25-L150-Z03	25	3	25	150	50	10		91,00 €
	AEM90-AP10-D25-W25-L150-Z03	25	3	25	150	50	10		97,00 €
	AEM90-AP10-D25-C25-L200-Z02	25	2	25	200	100	10		145,00 €
	AEM90-AP10-D25-C25-L200-Z03	25	3	25	200	100	10		155,00 €
	AEM90-AP10-D25-C25-L250-Z02	25	2	25	250	100	10		183,00 €
	AEM90-AP10-D30-C25-L100-Z04-H	30	4	25	100	30	10		107,00 €
	AEM90-AP10-D30-C25-L120-Z04-H	30	4	25	120	30	10		107,00 €
	AEM90-AP10-D30-C25-L150-Z04	30	4	25	150	30	10		107,00 €
	AEM90-AP10-D32-C25-L100-Z04-H	32	4	25	100	35	10		107,00 €
	AEM90-AP10-D32-C25-L120-Z04-H	32	4	25	120	35	10		107,00 €
	AEM90-AP10-D32-C25-L150-Z04	32	4	25	150	35	10		107,00 €
	AEM90-AP10-D32-W25-L150-Z04	32	4	25	150	35	10		107,00 €
	AEM90-AP10-D32-W32-L150-Z04	32	4	32	150	50	10		107,00 €
	AEM90-AP10-D40-W32-L150-Z05	40	5	32	150	40	10		123,00 €
	AEM90-AP10D-D16-W16-L150-Z02	16	2	16	150	50	10	AP.. 1003..	79,00 €
	AEM90-AP10D-D20-W20-L150-Z03	20	3	20	150	50	10	FOR DJT INSERT.	91,00 €
	NEW AEM90-AP100-D16-C15-L150-Z02	16	2	15	150	30	10	AP.. 1003..	84,00 €
	NEW AEM90-AP100-D21-C20-L150-Z03	21	3	20	150	30	10	FOR B.OKE	100,00 €
	NEW AEM90-AP100-D26-C25-L150-Z04	26	4	25	150	35	10	INSERT.	113,00 €
	NEW AEM90-AP100-D33-C32-L200-Z05	33	5	32	200	50	10		175,00 €
	NEW AEM90-AP10S-D16-W16-L150-Z02	16	2	16	150	26	10	AP.. 1003..	84,00 €
	NEW AEM90-AP10S-D20-W20-L150-Z02	20	2	20	150	26	10	FOR SMTM	89,00 €
	NEW AEM90-AP10S-D25-W25-L150-Z03	25	3	25	150	26	10	INSERT.	100,00 €
	AEM90-AP11-D16-C16-L150-Z02	16	2	16	150	50	11		79,00 €
	AEM90-AP11-D16-C16-L150-Z02-H	16	2	16	150	50	11	AP.. 11T3..	89,00 €
	AEM90-AP11-D16-W16-L150-Z02	16	2	16	150	50	11	FOR ZCC	79,00 €
	NEW AEM90-AP11-D16-W16-L150-Z02-H	16	2	16	150	50	11	INSERT.	89,00 €
AEM90-AP11-D16-C16-L200-Z02	16	2	16	200	100	11		112,00 €	
AEM90-AP11-D17-C16-L150-Z02	17	2	16	150	30	11		89,00 €	
AEM90-AP11-D17-C16-L200-Z02	17	2	16	200	30	11		123,00 €	
AEM90-AP11-D20-C20-L150-Z03	20	3	20	150	50	11		91,00 €	

END MILLS / WP - SCHAFTFRÄSER

	CODE / TYP	TOOL DIMENSIONS (mm) <small>MAS</small>						CUTTING INSERT WENDE PLATTE	PRICE / PREIS
		D	Z	d	L	l	a		
	AEM90-AP11-D20-W20-L150-Z03	20	3	20	150	50	11		91,00 €
	AEM90-AP11-D20-W20-L150-Z03-H	20	3	20	150	50	11		102,00 €
	AEM90-AP11-D20-C20-L200-Z03	20	3	20	200	100	11		150,00 €
	AEM90-AP11-D21-C20-L150-Z03	21	3	20	150	30	11		91,00 €
	AEM90-AP11-D21-W20-L150-Z03	21	3	20	150	30	11		91,00 €
	AEM90-AP11-D21-W20-L150-Z03-H	21	3	20	150	30	11		102,00 €
	AEM90-AP11-D21-C20-L200-Z03	21	3	20	200	30	11	AP. 11T3..	161,00 €
	AEM90-AP11-D25-C25-L150-Z03	25	3	25	150	50	11	FOR ZCC	97,00 €
	AEM90-AP11-D25-W25-L150-Z03	25	3	25	150	50	11	INSERT.	97,00 €
	AEM90-AP11-D25-W25-L150-Z03-H	25	3	25	150	50	11		107,00 €
	AEM90-AP11-D26-C25-L150-Z03	26	3	25	150	35	11		107,00 €
	AEM90-AP11-D26-C24-L150-Z03	26	3	24	150	47	11		107,00 €
	AEM90-AP11-D32-W25-L150-Z04	32	4	25	150	35	11		107,00 €
	AEM90-AP11-D32-W32-L150-Z03-H	32	3	32	150	50	11		107,00 €
	AEM90-AP11-D32-W32-L150-Z04	32	4	32	150	50	11		107,00 €
	<small>NEW</small> AEM90-AP1135A-D14-C16-L150-Z01	14	1	16	150	40	9.5		75,00 €
	<small>NEW</small> AEM90-AP1135A-D16-C16-L150-Z02	16	2	16	150	40	9.5		84,00 €
	<small>NEW</small> AEM90-AP1135A-D16-C16-L200-Z02	16	2	16	200	100	9.5		129,00 €
	<small>NEW</small> AEM90-AP1135A-D16-C16-L250-Z02	16	2	16	250	150	9.5		191,00 €
	<small>NEW</small> AEM90-AP1135A-D17-C16-L180-Z02	17	2	16	180	30	9.5	APMT 1135..	117,00 €
	<small>NEW</small> AEM90-AP1135A-D20-C20-L150-Z03	20	3	20	150	50	9.5	FOR ACHTK	100,00 €
	<small>NEW</small> AEM90-AP1135A-D20-C20-L200-Z02	20	2	20	200	100	9.5	INSERT.	129,00 €
	<small>NEW</small> AEM90-AP1135A-D21-C20-L180-Z02	21	2	20	180	30	9.5		117,00 €
	<small>NEW</small> AEM90-AP1135A-D25-C25-L200-Z03	25	3	25	200	100	9.5		166,00 €
	<small>NEW</small> AEM90-AP1135A-D26-C25-L250-Z02	26	2	25	250	35	9.5		170,00 €
	<small>NEW</small> AEM90-AP1135A-D33-C32-L250-Z02	33	2	32	250	35	9.5		170,00 €
	<small>NEW</small> AEM90-AP110-D16-C15-L150-Z02	16	2	15	150	30	11	APMT 1135..	84,00 €
	<small>NEW</small> AEM90-AP110-D21-C20-L150-Z03	21	3	20	150	30	11	FOR B.OKE	100,00 €
	<small>NEW</small> AEM90-AP110-D26-C25-L150-Z04	26	4	25	150	35	11	INSERT.	113,00 €
	<small>NEW</small> AEM90-AP110-D33-C32-L200-Z05	33	5	32	200	50	11		175,00 €
	<small>NEW</small> AEM90-APK11G-D16-W16-L150-Z02	16	2	16	150	26	11	APKT 1135..	84,00 €
	<small>NEW</small> AEM90-APK11G-D20-W20-L150-Z03	20	3	20	150	26	11	FOR XTC-GSC	100,00 €
	<small>NEW</small> AEM90-APK11G-D25-W25-L150-Z03	25	3	25	150	26	11	INSERT.	105,00 €
	AEM90-AP1135-D16-W16-L150-Z02	16	2	16	150	50	9.5	AP. 1135..	84,00 €
	AEM90-AP1135-D20-W20-L150-Z03	20	3	20	150	50	9.5	FOR XTC-GSC INSERT.	100,00 €
AEM90-AP1204-D20-C20-L150-Z02	20	2	20	150	30	12		118,00 €	
AEM90-AP1204-D21-C20-L150-Z02	21	2	20	150	30	12	AP. 1204..	118,00 €	
AEM90-AP1204-D21-C20-L200-Z02	21	2	20	200	30	12	FOR TGTC	171,00 €	
AEM90-AP1204-D25-C25-L150-Z03	25	3	25	150	40	12	INSERT.	129,00 €	
AEM90-AP1204-D26-C25-L250-Z02	26	2	25	250	35	12		236,00 €	
AEM90-AP1204-D32-C25-L150-Z03	32	3	25	150	35	12		134,00 €	
AEM90-AP16-D25-C20-L100-Z02	25	2	20	100	35	16		91,00 €	
AEM90-AP16-D25-W25-L100-Z02-H	25	2	25	100	35	16		91,00 €	
AEM90-AP16-D25-W25-L150-Z02	25	2	25	150	50	16		91,00 €	
AEM90-AP16-D25-C25-L250-Z02	25	2	25	250	100	16	AP. 1604..	183,00 €	
AEM90-AP16-D28-W25-L100-Z03-H	28	3	25	100	40	16	ISO	101,00 €	
AEM90-AP16-D28-W25-L150-Z03	28	3	25	150	40	16		101,00 €	
AEM90-AP16-D30-W25-L110-Z03-H	30	3	25	110	40	16		101,00 €	
AEM90-AP16-D30-W25-L150-Z02	30	2	25	150	40	16		97,00 €	

90°

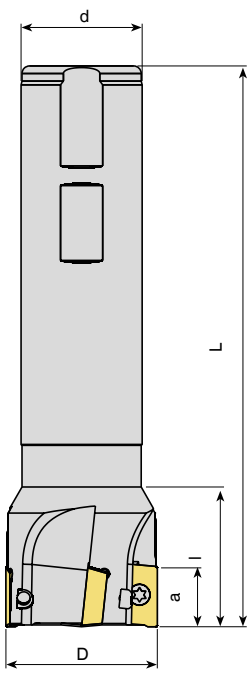

END MILLS / WP - SCHAFTFRÄSER

	CODE / TYP	TOOL DIMENSIONS (mm) <i>MAß</i>						CUTTING INSERT WENDE PLATTE	PRICE / PREIS
		D	Z	d	L	l	a		
 	AEM90-AP16-D30-W25-L150-Z03	30	3	25	150	40	16		101,00 €
	AEM90-AP16-D32-W32-L110-Z03-H	32	3	32	110	40	16		101,00 €
	AEM90-AP16-D32-C32-L150-Z03	32	3	32	150	50	16		101,00 €
	AEM90-AP16-D32-W25-L150-Z03	32	3	25	150	40	16		101,00 €
	AEM90-AP16-D32-W32-L150-Z03	32	3	32	150	50	16		101,00 €
	AEM90-AP16-D32-W32-L150-Z03-H	32	3	32	150	50	16		122,00 €
	AEM90-AP16-D32-C25-L200-Z03-H	32	3	25	200	40	16		163,00 €
	AEM90-AP16-D32-C32-L250-Z02	32	2	32	250	100	16	AP.. 1604..	183,00 €
	AEM90-AP16-D32-C32-L250-Z03	32	3	32	250	100	16	ISO	202,00 €
	AEM90-AP16-D35-W32-L150-Z03	35	3	32	150	40	16		106,00 €
	AEM90-AP16-D36-W32-L110-Z03-H	36	3	32	110	40	16		106,00 €
	AEM90-AP16-D36-W32-L150-Z03	36	3	32	150	40	16		106,00 €
	AEM90-AP16-D40-W32-L110-Z04-H	40	4	32	110	40	16		116,00 €
	AEM90-AP16-D40-C32-L150-Z04	40	4	32	150	40	16		116,00 €
	AEM90-AP16-D40-W32-L150-Z04	40	4	32	150	40	16		116,00 €
	AEM90-AP16-D40-C32-L250-Z02	40	2	32	250	40	16		192,00 €
	AEM90-AP16-D40-C32-L250-Z04	40	4	32	250	40	16		233,00 €
	AEM90-AP16D-D25-W25-L150-Z02	25	2	25	150	50	16		91,00 €
	AEM90-AP16D-D25-C25-L200-Z02	25	2	25	200	50	16	AP.. 1604..	140,00 €
	AEM90-AP16D-D32-W32-L150-Z03	32	3	32	150	50	16	FOR DJT	101,00 €
	AEM90-AP16D-D32-C32-L180-Z03	32	3	32	180	50	16	INSERT.	175,00 €
	AEM90-AP16D-D32-C32-L200-Z03	32	3	32	200	50	16		163,00 €
	AEM90-AP16L-D25-C25-L120-Z02-H	25	2	25	120	45	16		91,00 €
	AEM90-AP16L-D25-C25-L150-Z02	25	2	25	150	55	16		91,00 €
	AEM90-AP16L-D25-C25-L200-Z02	25	2	25	200	55	16		136,00 €
	AEM90-AP16L-D25-C25-L250-Z02	25	2	25	250	100	16		183,00 €
	AEM90-AP16L-D32-C32-L120-Z03-H	32	3	32	120	45	16	AP.. 1604..	101,00 €
	AEM90-AP16L-D32-C32-L150-Z03	32	3	32	150	55	16	FOR LMNA	101,00 €
	AEM90-AP16L-D32-C32-L200-Z03	32	3	32	200	55	16	INSERT.	150,00 €
	AEM90-AP16L-D32-C32-L250-Z03	32	3	32	250	100	16		202,00 €
	AEM90-AP16L-D40-C32-L120-Z04-H	40	4	32	120	40	16		116,00 €
	AEM90-AP16L-D40-C32-L150-Z04	40	4	32	150	40	16		116,00 €
	AEM90-AP16L-D40-C32-L200-Z04	40	4	32	200	40	16		172,00 €
	AEM90-AP16L-D40-C32-L250-Z04	40	4	32	250	40	16		233,00 €
	AEM90-AP16P-D25-W25-L100-Z02-H	25	2	25	100	35	16		91,00 €
	AEM90-AP16P-D25-W25-L150-Z02	25	2	25	150	50	16	AP.. 1604..	91,00 €
	AEM90-AP16P-D32-W32-L150-Z03	32	3	32	150	50	16	FOR PLBT	101,00 €
	AEM90-AP16P-D32-C32-L250-Z02	32	2	32	250	100	16	INSERT.	183,00 €
	AEM90-AP16P-D40-W32-L150-Z04	40	4	32	150	50	16		116,00 €
	AEM90-AP1705-D25-C25-L120-Z02	25	2	25	120	40	16		134,00 €
AEM90-AP1705-D26-C25-L200-Z02	26	2	25	200	40	16		198,00 €	
AEM90-AP1705-D26-C25-L250-Z02	26	2	25	250	40	16	AP.. 1705..	262,00 €	
NEW AEM90-AP1705-D26-C25-L300-Z02	26	2	25	300	40	16	FOR TGTC-LMNA	297,00 €	
AEM90-AP1705-D28-W25-L075-Z02	28	2	25	75	20	16	INSERT.	135,00 €	
AEM90-AP1705-D32-C25-L150-Z03	32	3	25	150	40	16		145,00 €	
NEW AEM90-AP1705-D33-C32-L250-Z03	33	3	32	250	40	16		300,00 €	
AEM90-AP1705-D33-C32-L300-Z02	33	2	32	300	40	16		305,00 €	

90°

END MILLS / WP - SCHAFTFRÄSER

70/71



	CODE / TYP	TOOL DIMENSIONS (mm) <i>MAS</i>						CUTTING INSERT WENDE PLATTE	PRICE / PREIS
		D	Z	d	L	l	a		
	AEM90-A01236-D16-C16-L85-Z02-H	16	2	16	85	30	12		113,00 €
	AEM90-A01236-D16-W16-L150-Z02	16	2	16	150	50	12	AO.. 1236..	113,00 €
	AEM90-A01236-D20-C20-L100-Z02-H	20	2	20	100	30	12	FOR MTSBH	123,00 €
	AEM90-A01236-D25-C25-L115-Z02-H	25	2	25	115	30	12	INSERT.	134,00 €
	AEM90-A01236-D25-W25-L150-Z03	25	3	25	150	50	12		138,00 €
	AEM90-A01236-D32-W32-L150-Z04	32	4	32	150	50	12		158,00 €
90°									
	<small>NEW</small> AEM90-AX0602-D10-C09-L120-Z02	10	2	9	120	15	5.7		134,00 €
	<small>NEW</small> AEM90-AX0602-D10-C10-L080-Z02	10	2	10	80	20	5.7		134,00 €
	AEM90-AX0602-D10-C10-L120-Z02	10	2	10	120	20	5.7		134,00 €
	<small>NEW</small> AEM90-AX0602-D12-C11-L120-Z02	12	2	11	120	15	5.7		134,00 €
	<small>NEW</small> AEM90-AX0602-D12-C12-L080-Z02	12	2	12	80	20	5.7	AX.T 0602..	134,00 €
	AEM90-AX0602-D12-C12-L120-Z02	12	2	12	120	20	5.7	FOR TGTC	134,00 €
	AEM90-AX0602-D14-C12-L120-Z03	14	3	12	120	20	5.7	INSERT.	150,00 €
	AEM90-AX0602-D16-W16-L120-Z04-H	16	4	16	120	20	5.7		115,00 €
	AEM90-AX0602-D16-W16-L150-Z04-H	16	4	16	150	20	5.7		130,00 €
	AEM90-AX0602-D20-W20-L120-Z05-H	20	5	20	120	25	5.7		136,00 €
	AEM90-AX0602-D20-W20-L150-Z05-H	20	5	20	150	25	5.7		150,00 €
	AEM90-AX0903-D16-C16-L120-Z02	16	2	16	120	30	8.8		97,00 €
	AEM90-AX0903-D16-C16-L180-Z02	16	2	16	180	30	8.8		145,00 €
	AEM90-AX0903-D17-C16-L120-Z02	17	2	16	120	25	8.8		97,00 €
	AEM90-AX0903-D17-C16-L180-Z02	17	2	16	180	25	8.8	AX.T 0903..	145,00 €
	AEM90-AX0903-D20-C20-L120-Z03	20	3	20	120	30	8.8	FOR TGTC	118,00 €
	AEM90-AX0903-D20-C20-L200-Z02	20	2	20	200	30	8.8	INSERT.	171,00 €
	AEM90-AX0903-D21-C20-L120-Z03	21	3	20	120	25	8.8		118,00 €
	AEM90-AX0903-D21-C20-L200-Z02	21	2	20	200	25	8.8		171,00 €
	AEM90-AX0903-D25-C25-L150-Z03	25	3	25	150	30	8.8		118,00 €
	AEM90-AX0903-D25-C25-L250-Z02	25	2	25	250	40	8.8		236,00 €
	90°	AEM90-AX0903-D26-C25-L150-Z03	26	3	25	150	30	8.8	

Cutting Calculation : P 114 / Schnittdatenberechnung : S 114

Ordering Example/Beispiel Bestellformular: 1pcs. AEM90-A01236-D16-C16-L85-Z02-H



END MILLS / WP - SCHAFTFRÄSER

	CODE / TYP	TOOL DIMENSIONS (mm) <small>MAß</small>						CUTTING INSERT WENDE PLATTE	PRICE / PREIS	
		D	Z	d	L	l	a			
	AEM90-AX1235-D16-C14-L120-Z02-H	16	2	14	120	25	10		112,00 €	
	AEM90-AX1235-D16-C15-L145-Z02-H	16	2	15	145	30	10		120,00 €	
	AEM90-AX1235-D16-C16-L100-Z02-H	16	2	16	100	30	10		112,00 €	
	AEM90-AX1235-D16-C16-L140-Z02-H	16	2	16	140	30	10		112,00 €	
	AEM90-AX1235-D16-C16-L145-Z02-H	16	2	16	145	30	10		120,00 €	
	AEM90-AX1235-D16-C16-L150-Z02	16	2	16	150	30	10		112,00 €	
	AEM90-AX1235-D20-C19-L150-Z02-H	20	2	19	150	40	10		128,00 €	
	AEM90-AX1235-D20-C20-L110-Z03-H	20	3	20	110	40	10		135,00 €	
	AEM90-AX1235-D20-C20-L150-Z02	20	2	20	150	40	10	AX.T 1235..	118,00 €	
	AEM90-AX1235-D20-C20-L150-Z02-H	20	2	20	150	40	10	FOR SMTM	128,00 €	
	AEM90-AX1235-D20-C20-L150-Z03	20	3	20	150	40	10	INSERT.	135,00 €	
	AEM90-AX1235-D25-C20-L120-Z04-H	25	4	20	120	30	10		158,00 €	
	AEM90-AX1235-D25-C20-L150-Z04-H	25	4	20	150	30	10		158,00 €	
	AEM90-AX1235-D25-C24-L170-Z02-H	25	2	24	170	50	10		143,00 €	
	AEM90-AX1235-D25-C25-L120-Z04-H	25	4	25	120	40	10		143,00 €	
	AEM90-AX1235-D25-C25-L150-Z03	25	3	25	150	50	10		142,00 €	
	AEM90-AX1235-D25-C25-L170-Z02-H	25	2	25	170	50	10		143,00 €	
	AEM90-AX1235-D25-W25-L100-Z04-H	25	4	25	100	30	10		158,00 €	
	AEM90-AX1235-D32-C32-L130-Z05-H	32	5	32	130	40	10		168,00 €	
	AEM90-AX1235-D32-C32-L180-Z02-H	32	2	32	180	50	10		150,00 €	
AEM90-AX1705-D25-C25-L150-Z02	25	2	25	150	50	14		130,00 €		
AEM90-AX1705-D28-W25-L115-Z02-H	28	2	25	115	35	14	AX.T 1705..	138,00 €		
AEM90-AX1705-D32-C32-L150-Z03	32	3	32	150	50	14	FOR SMTM	154,00 €		
AEM90-AX1705-D32-C32-L180-Z02-H	32	2	32	180	50	14	INSERT.	170,00 €		
90°										
	AEM90-AZ11-D12-W16-L90-Z01	12	1	16	90	30	11		67,00 €	
	AEM90-AZ11-D16-C16-L200-Z02	16	2	16	200	100	11		112,00 €	
	AEM90-AZ11-D16-W15-L170-Z02	16	2	15	170	50	11		94,00 €	
	AEM90-AZ11-D16-W16-L100-Z02	16	2	16	100	35	11		79,00 €	
	AEM90-AZ11-D16-W16-L150-Z02	16	2	16	150	50	11		79,00 €	
	AEM90-AZ11-D17-C16-L150-Z02	17	2	16	150	30	11		79,00 €	
	AEM90-AZ11-D17-C16-L180-Z02	17	2	16	180	50	11		115,00 €	
	AEM90-AZ11-D17-W16-L100-Z02	17	2	16	100	30	11		89,00 €	
	AEM90-AZ11-D20-C20-L200-Z03	20	3	20	200	100	11	AZGT 1135..	170,00 €	
	AEM90-AZ11-D20-W19-L170-Z03	20	3	19	170	50	11	FOR ZCC	109,00 €	
	AEM90-AZ11-D20-W20-L110-Z02	20	2	20	110	35	11	INSERT.	91,00 €	
	AEM90-AZ11-D21-C20-L150-Z03	21	3	20	150	30	11		91,00 €	
	AEM90-AZ11-D21-C20-L180-Z03	21	3	20	180	50	11		117,00 €	
	AEM90-AZ11-D21-W20-L110-Z03	21	3	20	110	35	11		91,00 €	
	AEM90-AZ11-D25-C24-L180-Z04	25	4	24	180	50	11		157,00 €	
	AEM90-AZ11-D25-W25-L110-Z04	25	4	25	110	40	11		138,00 €	
	AEM90-AZ11-D26-C25-L250-Z02	26	2	25	250	50	11		204,00 €	
	AEM90-AZ11-D26-W25-L120-Z03	26	3	25	120	30	11		97,00 €	
	AEM90-AZ11-D26-W25-L120-Z04	26	4	25	120	40	11		128,00 €	
	AEM90-AZ11-D28-C25-L250-Z02	28	2	25	250	50	11		204,00 €	
	AEM90-AZ11-D33-W32-L130-Z04	33	4	32	130	50	11		111,00 €	
	90°									

END MILLS / WP - SCHAFTFRÄSER

72/73



	CODE / TYP	TOOL DIMENSIONS (mm) <small>MAS</small>						CUTTING INSERT <small>WENDE PLATTE</small>	PRICE / PREIS
		D	Z	d	L	l	a		
	<small>NEW</small> AEM90-BD11T3-D16-C16-L100-Z02-H	16	2	16	100	30	10		87,00 €
	AEM90-BD11T3-D16-W16-L100-Z02-H	16	2	16	100	30	10		87,00 €
	AEM90-BD11T3-D16-W16-L150-Z02	16	2	16	150	50	10		87,00 €
	<small>NEW</small> AEM90-BD11T3-D16-C15-L180-Z02	16	2	15	180	50	10		114,00 €
	AEM90-BD11T3-D17-W16-L150-Z02	17	2	16	150	25	10		97,00 €
	<small>NEW</small> AEM90-BD11T3-D17-C16-L180-Z02	17	2	16	180	50	10		128,00 €
	<small>NEW</small> AEM90-BD11T3-D18-W16-L100-Z02	18	2	16	100	25	10		87,00 €
	AEM90-BD11T3-D18-W16-L100-Z02-H	18	2	16	100	25	10		87,00 €
	<small>NEW</small> AEM90-BD11T3-D20-W20-L100-Z02-H	20	2	20	100	30	10		87,00 €
	AEM90-BD11T3-D20-W20-L100-Z03-H	20	3	20	100	30	10		104,00 €
	<small>NEW</small> AEM90-BD11T3-D20-C20-L110-Z03-H	20	3	20	110	30	10		104,00 €
	<small>NEW</small> AEM90-BD11T3-D20-W20-L150-Z02	20	2	20	150	50	10	BDMT 11T3..	87,00 €
	AEM90-BD11T3-D20-W20-L150-Z03	20	3	20	150	50	10	FOR KYCR	104,00 €
	AEM90-BD11T3-D21-W20-L150-Z03	21	3	20	150	25	10	INSERT.	112,00 €
	<small>NEW</small> AEM90-BD11T3-D21-C20-L200-Z02	21	2	20	200	25	10		160,00 €
	AEM90-BD11T3-D22-W20-L090-Z02-H	22	2	20	90	25	10		92,00 €
	AEM90-BD11T3-D25-W25-L100-Z03-H	25	3	25	100	30	10		108,00 €
	<small>NEW</small> AEM90-BD11T3-D25-C25-L120-Z03-H	25	3	25	120	30	10		108,00 €
	AEM90-BD11T3-D25-W25-L150-Z03	25	3	25	150	50	10		108,00 €
	AEM90-BD11T3-D26-W25-L150-Z03	26	3	25	150	35	10		112,00 €
	<small>NEW</small> AEM90-BD11T3-D26-C25-L250-Z02	26	2	25	250	35	10		241,00 €
	AEM90-BD11T3-D32-W32-L110-Z04-H	32	4	32	110	40	10		125,00 €
	<small>NEW</small> AEM90-BD11T3-D32-C32-L130-Z04-H	32	4	32	130	40	10		125,00 €
	AEM90-BD11T3-D32-W32-L150-Z04	32	4	32	150	50	10		125,00 €
	AEM90-BD11T3-D40-W32-L110-Z04-H	40	4	32	110	35	10		163,00 €
	AEM90-BD1704-D25-W25-L100-Z02-H	25	2	25	100	35	15.7		108,00 €
	AEM90-BD1704-D25-W25-L150-Z02	25	2	25	150	50	15.7		108,00 €
	AEM90-BD1704-D32-W32-L110-Z03-H	32	3	32	110	40	15.7	BDMT 1704..	125,00 €
	AEM90-BD1704-D32-W32-L150-Z03	32	3	32	150	50	15.7	FOR KYCR	125,00 €
	AEM90-BD1704-D40-W32-L110-Z04-H	40	4	32	110	40	15.7	INSERT.	142,00 €
AEM90-BD1704-D40-W32-L150-Z04	40	4	32	150	40	15.7		142,00 €	
90°									
	<small>NEW</small> AEM90-ED10T3-D16-W16-L120-Z02	16	2	16	120	30	10	EDPT 10T3..	112,00 €
	<small>NEW</small> AEM90-ED10T3-D20-W20-L120-Z02	20	2	20	120	30	10	FOR KNMTL INSERT.	112,00 €
	AEM90-ED1404-D20-W20-L150-Z02	20	2	20	150	50	14.5	EDPT 1404..	112,00 €
	AEM90-ED1404-D25-W25-L150-Z02	25	2	25	150	50	14.5	FOR KNMTL	123,00 €
	AEM90-ED1404-D30-C25-L150-Z03	30	3	25	150	50	14.5	INSERT.	160,00 €
90°									
	AEM90-LN08-D16-W16-L100-Z02-H	16	2	16	100	28	8	LNMT 0804..	128,00 €
	AEM90-LN08-D20-W20-L100-Z03-H	20	3	20	100	28	8	FOR ISCR	153,00 €
	AEM90-LN08-D25-W25-L100-Z03-H	25	3	25	100	30	8	INSERT.	163,00 €
	AEM90-LN08-D32-W32-L110-Z05-H	32	5	32	110	30	8		189,00 €
90°									

END MILLS / WP - SCHAFTFRÄSER

	CODE / TYP	TOOL DIMENSIONS (mm) <small>MAß</small>						CUTTING INSERT <small>WENDE PLATTE</small>	PRICE / PREIS
		D	Z	d	L	l	a		
 90°	AEM90-LN15T6-D25-W25-L150-Z02-H	25	2	25	150	50	15.5	LNGU 15T6..	123,00 €
	AEM90-LN15T6-D32-W32-L150-Z03-H	32	3	32	150	50	15.5	FOR KNMTL	142,00 €
	AEM90-LN15T6-D40-W32-L150-Z03-H	40	3	32	150	40	15.5	INSERT.	155,00 €
 90°	AEM90-LN1106-D25-W25-L150-Z03	25	3	25	150	40	10	LNMT 1106..	139,00 €
	AEM90-LN1106-D32-W32-L150-Z04	32	4	32	150	40	10	FOR ISCR-XTC-GSC	162,00 €
	AEM90-LN1106-D40-W32-L150-Z05	40	5	32	150	40	10	INSERT.	184,00 €
 90°	AEM90-R390.11-D16-W16-L100-Z02-H	16	2	16	100	30	10		91,00 €
	AEM90-R390.11-D16-W16-L150-Z02	16	2	16	150	50	10		91,00 €
	AEM90-R390.11-D16-W16-L150-Z02-H	16	2	16	150	50	10		106,00 €
	AEM90-R390.11-D20-W20-L090-Z02-H	20	2	20	90	30	10		87,00 €
	AEM90-R390.11-D20-W20-L100-Z03-H	20	3	20	100	30	10		106,00 €
	AEM90-R390.11-D20-W20-L150-Z03	20	3	20	150	50	10		106,00 €
	AEM90-R390.11-D20-W20-L150-Z03-H	20	3	20	150	50	10	R390-11T3..	121,00 €
	AEM90-R390.11-D20-C20-L150-Z03	20	3	20	150	30	10	FOR SNDVK	106,00 €
	AEM90-R390.11-D22-W20-L090-Z02-H	22	2	20	90	30	10	INSERT.	87,00 €
	AEM90-R390.11-D25-C20-L150-Z03	25	3	20	150	40	10		106,00 €
	AEM90-R390.11-D25-W25-L100-Z03-H	25	3	25	100	30	10		106,00 €
	AEM90-R390.11-D25-W25-L150-Z03	25	3	25	150	50	10		106,00 €
	AEM90-R390.11-D25-W25-L150-Z03-H	25	3	25	150	50	10		121,00 €
	AEM90-R390.11-D30-W25-L150-Z04-H	30	4	25	150	30	10		148,00 €
	AEM90-R390.11-D32-C25-L200-Z03	32	3	25	200	40	10		163,00 €
	AEM90-R390.11-D32-W32-L150-Z05-H	32	5	32	150	50	10		164,00 €
	AEM90-R390.17-D25-W25-L150-Z02	25	2	25	150	50	15.4		106,00 €
	AEM90-R390.17-D25-W25-L150-Z02-H	25	2	25	150	50	15.4	R390-1704..	121,00 €
	AEM90-R390.17-D30-W25-L150-Z03	30	3	25	150	40	15.4	FOR SNDVK	121,00 €
	AEM90-R390.17-D30-W25-L150-Z03-H	30	3	25	150	40	15.4	INSERT.	140,00 €
	AEM90-R390.17-D32-W32-L150-Z03-H	32	3	32	150	40	15.4		140,00 €
	AEM90-R390.18-D32-C32-L150-Z03	32	3	32	150	45	15.4	R390-1806..	121,00 €
								FOR SNDVK	
								INSERT.	

END MILLS / WP - SCHAFTFRÄSER

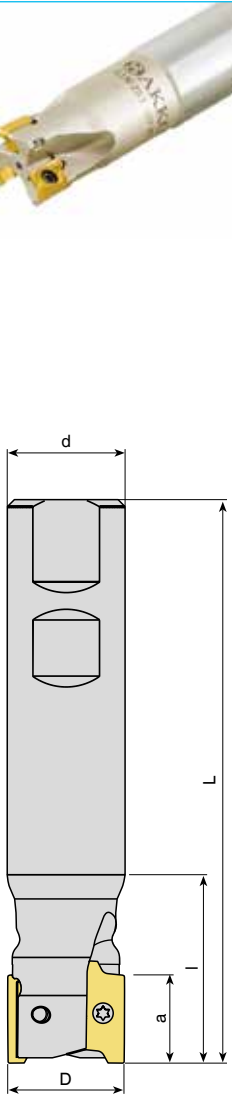
74/75





	CODE / TYP	TOOL DIMENSIONS (mm) <small>MAS</small>						CUTTING INSERT WENDE PLATTE	PRICE / PREIS
		D	Z	d	L	l	a		
	AEM90-RT07-D10-W10-L120-Z02	10	2	10	120	30	7	RT 0702..	82,00 €
	AEM90-RT07-D12-W12-L120-Z02	12	2	12	120	30	7	FOR SFTY	82,00 €
	AEM90-RT07-D12-C12-L120-Z02	12	2	12	120	30	7	INSERT.	82,00 €
	AEM90-RT07-D14-W12-L120-Z02	14	2	12	120	30	7		82,00 €
	AEM90-RT10-D16-W16-L120-Z02-H	16	2	15	160	30	10		82,00 €
	AEM90-RT10-D16-W16-L150-Z02	16	2	16	120	30	10		82,00 €
	AEM90-RT10-D16-C15-L160-Z02	16	2	16	150	50	10		102,00 €
	AEM90-RT10-D16-C16-L200-Z02	16	2	16	200	100	10		121,00 €
	AEM90-RT10-D17-W16-L160-Z02	17	2	16	160	30	10		102,00 €
	AEM90-RT10-D17-C16-L200-Z02	17	2	16	200	30	10		112,00 €
	AEM90-RT10-D18-W16-L120-Z02-H	18	2	16	120	30	10		82,00 €
	AEM90-RT10-D20-W20-L120-Z03-H	20	3	19	200	30	10		101,00 €
	AEM90-RT10-D20-W20-L150-Z03	20	3	20	120	30	10		101,00 €
	AEM90-RT10-D20-C19-L200-Z03	20	3	20	150	50	10		163,00 €
	<small>NEW</small> AEM90-RT10-D20-C20-L110-Z03	20	3	20	110	30	10	RT 1003..	101,00 €
	AEM90-RT10-D20-C20-L200-Z03	20	3	20	200	100	10	FOR SFTY	142,00 €
	AEM90-RT10-D21-W20-L200-Z03	21	3	20	200	30	10	INSERT.	169,00 €
	AEM90-RT10-D22-W20-L120-Z03-H	22	3	20	120	30	10		101,00 €
	AEM90-RT10-D22-C20-L150-Z03	22	3	20	150	30	10		101,00 €
	AEM90-RT10-D22-C20-L200-Z03	22	3	20	200	30	10		169,00 €
	AEM90-RT10-D25-W25-L120-Z04-H	25	4	25	120	40	10		111,00 €
	AEM90-RT10-D25-W25-L150-Z04	25	4	25	150	50	10		111,00 €
	AEM90-RT10-D25-C25-L200-Z04	25	4	25	200	100	10		152,00 €
	AEM90-RT10-D26-C25-L250-Z04	26	4	25	250	32	10		194,00 €
	AEM90-RT10-D32-W32-L120-Z05-H	32	5	32	120	50	10		121,00 €
	AEM90-RT10-D32-W32-L150-Z05	32	5	32	150	50	10		121,00 €
	AEM90-RT10-D32-C32-L200-Z05	32	5	32	200	100	10		162,00 €
	AEM90-RT10-D33-C32-L250-Z04	33	4	32	250	32	10		225,00 €
	AEM90-RT13-D32-C32-L250-Z04	32	4	32	250	50	13	RT 1304..	225,00 €
	AEM90-RT16-D25-W25-L120-Z02-H	25	2	25	120	40	16		101,00 €
	AEM90-RT16-D25-W25-L150-Z02	25	2	25	150	50	16		101,00 €
	AEM90-RT16-D25-C25-L200-Z02	25	2	25	200	100	16		142,00 €
AEM90-RT16-D32-W32-L120-Z03-H	32	3	32	120	50	16		111,00 €	
AEM90-RT16-D32-W32-L150-Z03	32	3	32	150	50	16	RT 1606..	111,00 €	
AEM90-RT16-D32-C32-L200-Z03	32	3	32	200	100	16	FOR SFTY	152,00 €	
AEM90-RT16-D32-C32-L250-Z03	32	3	32	250	100	16	INSERT.	183,00 €	
AEM90-RT16-D32-C32-L270-Z03	32	3	32	270	100	16		192,00 €	
AEM90-RT16-D40-W32-L120-Z04-H	40	4	32	120	50	16		121,00 €	
AEM90-RT16-D40-W32-L150-Z04	40	4	32	150	50	16		121,00 €	
90° AEM90-RT16-D40-C32-L200-Z04	40	4	32	200	100	16		162,00 €	
	AEM90-SE09-D25-C25-L120-Z03-H	25	3	25	120	60	6.7	SEET 09T3..	102,00 €
	AEM90-SE09-D25-C25-L150-Z02	25	2	25	150	50	6.7	FOR ZCC	87,00 €
	AEM90-SE09-D32-C32-L120-Z04-H	32	4	32	120	60	6.7	INSERT.	118,00 €
	AEM90-SE09-D32-C32-L150-Z03	32	3	32	150	50	6.7		102,00 €
	90°								

END MILLS / WP - SCHAFTFRÄSER



	CODE / TYP	TOOL DIMENSIONS (mm) <small>MAß</small>						CUTTING INSERT WENDE PLATTE	PRICE / PREIS
		D	Z	d	L	l	a		
 90°	AEM90-S00803-D20-C16-L110-Z02-H	20	2	16	110	25	7	SOMT 0803..	110,00 €
	AEM90-S00803-D25-C20-L110-Z02-H	25	2	20	110	25	7	FOR SMTM	119,00 €
	AEM90-S00803-D32-C25-L120-Z03-H	32	3	25	120	30	7	INSERT.	147,00 €
 90°	AEM90-SPGT0602-D16-W16-L150-Z02	16	2	16	150	50	5.5	SPGT 0602..	119,00 €
	AEM90-SPGT07T3-D20-W20-L150-Z03	20	3	20	150	50	7	SPGT 07T3..	133,00 €
	AEM90-SPGT07T3-D25-W25-L150-Z03	25	3	25	150	50	7	FOR ZCC INSERT.	142,00 €
	AEM90-SPGT0904-D30-W32-L150-Z03	30	3	32	150	50	9	SPGT 0904..	146,00 €
							FOR ZCC INSERT.		
 90°	AEM90-TNG10-D20-C20-L125-Z02-H	20	2	20	125	29	5		134,00 €
	AEM90-TNG10-D20-C20-L125-Z03-H	20	3	20	125	29	5		159,00 €
	AEM90-TNG10-D20-C20-L150-Z03-H	20	3	20	150	50	5	TNGX 1004..	192,00 €
	AEM90-TNG10-D25-C25-L150-Z03-H	25	3	25	150	34	5	FOR PRMT	192,00 €
	AEM90-TNG10-D25-C25-L150-Z04-H	25	4	25	150	34	5	INSERT.	217,00 €
	AEM90-TNG10-D25-C25-L170-Z04-H	25	4	25	170	50	5		246,00 €
	AEM90-TNG10-D32-C32-L170-Z04-H	32	4	32	170	37	5		270,00 €
	AEM90-TNG10-D32-C32-L170-Z05-H	32	5	32	170	37	5		295,00 €
 90°	AEM90-WN0604Z-D25-W25-L150-Z02-H	25	2	25	150	50	5.7	WNHU 0604..	132,00 €
	AEM90-WN0604Z-D32-W32-L150-Z03-H	32	3	32	150	50	5.7	FOR ZCC	145,00 €
	AEM90-WN0604Z-D40-W32-L150-Z04-H	40	4	32	150	35	5.7	INSERT.	165,00 €
 90°	AEM90-XC13-D20-W20-L150-Z02	20	2	20	150	60	13	XCKX 13T3..	97,00 €
	AEM90-XC13-D25-W25-L150-Z03	25	3	25	150	60	13	FOR SC	101,00 €
	AEM90-XC13-D32-W32-L150-Z04	32	4	32	150	60	13	INSERT.	116,00 €

END MILLS / WP - SCHAFTFRÄSER



76/77

	CODE / TYP	TOOL DIMENSIONS (mm) <small>MAS</small>						CUTTING INSERT WENDE PLATTE	PRICE / PREIS
		D	Z	d	L	l	a		
	AEM90-XD11T3-D16-W16-L150-Z02	16	2	16	150	40	10		91,00 €
	AEM90-XD11T3-D17-C16-L150-Z02	17	2	16	150	30	10		91,00 €
	AEM90-XD11T3-D20-W20-L150-Z03	20	3	20	150	50	10	XD.T 11T3..	106,00 €
	<small>NEW</small> AEM90-XD11T3-D21-C20-L080-Z03-H	21	3	20	80	25	10	FOR CRTZT	106,00 €
	AEM90-XD11T3-D21-C20-L150-Z03	21	3	20	150	30	10	INSERT.	106,00 €
	AEM90-XD11T3-D25-W25-L150-Z04	25	4	25	150	50	10		120,00 €
	AEM90-XD11T3-D32-W32-L150-Z04	32	4	32	150	50	10		124,00 €
<small>NEW</small> AEM90-XD11T3-D33-C20-L080-Z04-H	33	4	20	80	30	10		124,00 €	
90°									
	AEM90-X006-D10-C12-L120-Z02	10	2	12	120	50	5	XO.. 0602..	134,00 €
	AEM90-X006-D12-C12-L120-Z02	12	2	12	120	25	5	FOR SC INSERT.	134,00 €
	AEM90-X009-D16-W16-L150-Z02	16	2	16	150	50	8	XO.. 0903..	101,00 €
	AEM90-X009-D20-W20-L150-Z03	20	3	20	150	50	8	FOR SC INSERT.	114,00 €
	AEM90-X012-D20-W20-L150-Z02	20	2	20	150	50	11		91,00 €
	AEM90-X012-D20-C20-L200-Z02	20	2	20	200	100	11		140,00 €
	AEM90-X012-D22-W20-L150-Z02	22	2	20	150	20	11	XO.. 1204..	91,00 €
	AEM90-X012-D25-W25-L150-Z03	25	3	25	150	50	11	FOR SC	101,00 €
	AEM90-X012-D25-C25-L200-Z03	25	3	25	200	100	11	INSERT.	155,00 €
	AEM90-X012-D32-C25-L150-Z04	32	4	25	150	40	11		116,00 €
	AEM90-X012-D32-W32-L150-Z04	32	4	32	150	50	11		116,00 €
AEM90-X012-D32-C32-L250-Z04	32	4	32	250	100	11		302,00 €	
90°									
	AEM90-ZC1003-D16-C14-L150-Z02	16	2	14	150	25	9		79,00 €
	AEM90-ZC1003-D16-C14-L200-Z02	16	2	14	200	25	9		119,00 €
	AEM90-ZC1003-D16-C15-L150-Z02	16	2	15	150	25	9		79,00 €
	AEM90-ZC1003-D16-C16-L150-Z02	16	2	16	150	25	9		79,00 €
	AEM90-ZC1003-D17-C16-L150-Z02	17	2	16	150	25	9		79,00 €
	AEM90-ZC1003-D17-C16-L200-Z02	17	2	16	200	25	9		118,00 €
	AEM90-ZC1003-D20-C18-L150-Z03	20	3	18	150	25	9		91,00 €
	AEM90-ZC1003-D20-C18-L200-Z02	20	2	18	200	25	9	ZCMT 100308R	132,00 €
	AEM90-ZC1003-D20-C20-L150-Z03	20	3	20	150	40	9	FOR DJT	91,00 €
	AEM90-ZC1003-D20-C18-L200-Z03	20	3	18	200	25	9	INSERT.	138,00 €
	<small>NEW</small> AEM90-ZC1003-D21-C20-L150-Z02	21	2	20	150	30	9		79,00 €
	AEM90-ZC1003-D21-C20-L150-Z03	21	3	20	150	30	9		91,00 €
	AEM90-ZC1003-D21-C20-L200-Z03	21	3	20	200	30	9		143,00 €
	AEM90-ZC1003-D25-C20-L150-Z03	25	3	20	150	30	9		91,00 €
	AEM90-ZC1003-D25-C20-L200-Z03	25	3	20	200	30	9		142,00 €
	AEM90-ZC1003-D25-C25-L150-Z03	25	3	25	150	40	9		91,00 €
	AEM90-ZC1003-D26-C25-L170-Z03	26	3	25	170	25	9		103,00 €
	AEM90-ZC1003-D26-C25-L200-Z03	26	3	25	200	25	9		138,00 €
	AEM90-ZC1003-D32-C25-L180-Z04	32	4	25	180	30	9		149,00 €
AEM90-ZC1003-D33-C32-L200-Z04	33	4	32	200	25	9		155,00 €	
90°									
	AEM90-ZP13T3-D26-C25-L200-Z02	26	2	25	200	35	13	ZPMT 13T3..	131,00 €
	AEM90-ZP13T3-D26-C25-L200-Z03	26	3	25	200	35	13	FOR DJT	138,00 €
	AEM90-ZP13T3-D26-C25-L250-Z02	26	2	25	250	35	13	INSERT.	184,00 €
	AEM90-ZP13T3-D33-C32-L200-Z03	33	3	32	200	40	13		155,00 €
	AEM90-ZP13T3-D33-C32-L250-Z03	33	3	32	250	40	13		205,00 €
90°									

END MILLS / WP - SCHAFTFRÄSER

	CODE / TYP	TOOL DIMENSIONS (mm) <i>MAß</i>						CUTTING INSERT WENDE PLATTE	PRICE / PREIS
		D	Z	d	L	l	a		
 90°	AEM90-3P1004-D20-W20-L150-Z02	20	2	20	150	40	7	3P.T 100408	108,00 €
	AEM90-3P1004-D25-W25-L150-Z03	25	3	25	150	40	7	FOR TGTC INSERT.	124,00 €
	AEM90-3P1505-D32-W32-L150-Z03	32	3	32	150	50	11	3P.T 150508	130,00 €
	AEM90-3P1505-D40-W32-L150-Z04	40	4	32	150	50	11	FOR TGTC INSERT.	146,00 €
 90°	AEM90-4N06-D16-W16-L120-Z02-H	16	2	16	120	25	6	4NKT 0603..	102,00 €
	AEM90-4N06-D16-W16-L160-Z02	16	2	16	160	25	6	FOR TGTC	102,00 €
	AEM90-4N06-D20-W16-L120-Z03-H	20	3	16	120	20	6	INSERT.	128,00 €
	AEM90-4N06-D20-W16-L160-Z03	20	3	16	160	20	6		128,00 €

S - SYSTEM FACE AND COPY END MILLS / S-SYSTEM KOPIER - UND SCHAFTFRÄSER

	CODE / TYP	TOOL DIMENSIONS (mm) <i>MAß</i>						CUTTING INSERT WENDE PLATTE	PRICE / PREIS
		D	Z	d	L	l			
 -°	AEMR-RP08T2M-D20-W20-L150-Z02-H	20	2	20	150	60		RPMT 08T2..	133,00 €
	AEMR-RP08T2M-D25-W25-L200-Z03-H	25	3	25	200	100		FOR MTSBSH INSERT.	204,00 €
	AEMR-RP10T3M-D25-W25-L200-Z02-H	25	2	25	200	100		RPMT 10T3..	179,00 €
	AEMR-RP1204M-D32-W32-L150-Z03-H	32	3	32	150	60		RPMT 1204..	148,00 €
	AEMR-RP1204M-D32-W32-L200-Z03-H	32	3	32	200	100		FOR MTSBSH INSERT.	222,00 €
 -°	AEMR-RY08-D16-W16-L150-Z02	16	16	2	150	55		RYMX 0803..	107,00 €
	AEMR-RY10-D20-W20-L150-Z02	20	20	2	150	60			117,00 €
	AEMR-RY10-D20-C20-L200-Z02	20	20	2	200	100		RYMX 1004..	158,00 €
	AEMR-RY10-D21-W20-L200-Z02-H	21	20	2	200	30		FOR TGTC	189,00 €
	AEMR-RY10-D25-W25-L150-Z02	25	25	2	150	60		INSERT.	128,00 €
	AEMR-RY10-D26-W25-L200-Z02-H	26	25	2	200	60			228,00 €
	AEMR-RY10-D32-W32-L160-Z04-H	32	32	4	160	60			203,00 €
AEMR-RY12-D32-C25-L160-Z03	32	25	3	160	30		RYMX 1205..	157,00 €	
 -°	AEMR-QP10T3-D20-C20-L150-Z01-H	20	1	20	150	70			134,00 €
	AEMR-QP10T3-D25-C25-L120-Z02-H	25	2	25	120	40			156,00 €
	AEMR-QP10T3-D25-C25-L150-Z02-H	25	2	25	150	70		QP.. 10T3..	156,00 €
	AEMR-QP10T3-D25-C25-L170-Z02	25	2	25	170	90		FOR SMTM	147,00 €
	AEMR-QP10T3-D32-C32-L150-Z03-H	32	3	32	150	70		INSERT.	179,00 €
	AEMR-QP10T3-D32-C32-L170-Z03	32	3	32	170	90			158,00 €
	AEMR-QP1204-D25-C25-L150-Z02-H	25	2	25	150	70		QP.. 1204.. SMTM	156,00 €

S - SYSTEM FACE AND COPY END MILLS / S-SYSTEM KOPIER - UND SCHAFTFRÄSER

	CODE / TYP	TOOL DIMENSIONS (mm) MAß					CUTTING INSERT WENDE PLATTE	PRICE / PREIS
		D	Z	d	L	l		
	AEMR-RD0501-D08-W10-L100-Z01-H	8	1	10	100	20		93,00 €
	AEMR-RD0501-D10-W12-L100-Z02-H	10	2	12	100	20	RD.. 0501	106,00 €
	AEMR-RD0501-D12-W12-L120-Z02-H	12	2	12	120	20		106,00 €
	AEMR-RD0803-D16-W16-L150-Z02	16	2	16	150	60	RD.. 0803	84,00 €
	AEMR-RD0803-D16-C20-L200-Z02	16	3	20	200	60	ISO	131,00 €
	NEW AEMR-RD0803-D20-W20-L150-Z03	20	2	20	150	60		125,00 €
	AEMR-RD08T2-D16-W16-L150-Z02	16	2	16	150	60	RD.. 08T2	84,00 €
	AEMR-RD08T2-D20-W20-L150-Z02	20	2	20	150	60	ISO	103,00 €
	AEMRC-RD1003-D20-W20-L150-Z02	20	2	20	150	60		103,00 €
	AEMRC-RD1003-D20-C20-L160-Z02	20	2	20	160	70		111,00 €
	AEMRC-RD1003-D20-C20-L250-Z02	20	2	20	250	150		187,00 €
	AEMRC-RD1003-D21-C20-L160-Z02	21	2	20	160	70		111,00 €
	AEMRC-RD1003-D25-W25-L150-Z02	25	2	25	150	60		103,00 €
	AEMRC-RD1003-D25-C25-L160-Z02	25	2	25	160	70		111,00 €
	AEMRC-RD1003-D25-W25-L200-Z02	25	2	25	200	100		140,00 €
	AEMRC-RD1003-D25-C25-L200-Z02	25	2	25	200	100	RD.. 1003	140,00 €
	AEMRC-RD1003-D25-C25-L250-Z02	25	2	25	250	150	ISO	187,00 €
	AEMRC-RD1003-D26-C25-L160-Z02	26	2	25	160	70		111,00 €
	AEMRC-RD1003-D32-W32-L150-Z03	32	3	32	150	60		116,00 €
	AEMRC-RD1003-D32-C32-L250-Z02	32	2	32	250	150		196,00 €
	AEMRC-RD1003-D33-C32-L160-Z03	33	3	32	160	70		125,00 €
	AEMRC-RD1003-D40-W32-L150-Z04	40	4	32	150	35		131,00 €
	AEMRC-RD1003-D40-C32-L250-Z02	40	2	32	250	35		205,00 €
	AEMRC-RD10T3-D20-W20-L150-Z02	20	2	20	150	60	RD.. 10T3	103,00 €
	AEMRC-RD10T3-D25-W25-L150-Z02	25	2	25	150	60	ISO	103,00 €
	AEMRC-RD10T3-D32-W32-L150-Z03	32	3	32	150	60		116,00 €
	AEMRC-RD1204-D32-C32-L160-Z03	32	3	32	160	70	RD.. 1204	125,00 €
	AEMRC-RD1204-D32-W32-L160-Z03	32	3	32	160	50	ISO	125,00 €
	AEMRC-RD1204-D33-C32-L160-Z03	33	3	32	160	70		125,00 €
	AEMRC-RD12T3-D25-W25-L150-Z02	25	2	25	150	60		103,00 €
	AEMRC-RD12T3-D25-W25-L200-Z02	25	2	25	200	100		140,00 €
	AEMRC-RD12T3-D25-C25-L250-Z02	25	2	25	250	150		187,00 €
	NEW AEMRC-RD12T3-D25-C25-L300-Z02	25	2	25	300	200	RD.. 12T3	250,00 €
AEMRC-RD12T3-D32-W32-L150-Z03	32	3	32	150	60	ISO	116,00 €	
AEMRC-RD12T3-D32-C32-L250-Z02	32	2	32	250	150		196,00 €	
AEMRC-RD12T3-D40-W32-L150-Z04	40	4	32	150	50		131,00 €	
AEMRC-RD12T3-D40-C32-L250-Z02	40	2	32	250	50		205,00 €	
AEMRC-RD1604-D40-W32-L150-Z02	40	2	32	150	35	RD.. 1604	121,00 €	
						ISO		
	AEMR-RP10T3-D25-W25-L150-Z02	25	2	25	150	60	RPNX 10T3..	116,00 €
	AEMR-RP10T3-D32-W32-L150-Z03	32	3	32	150	60	FOR CRTZT	132,00 €
							INSERT.	

S - SYSTEM HIGHFEED END MILLS / S - SYSTEM HOCHGESCHWINDIGKEITS

	CODE / TYP	TOOL DIMENSIONS (mm) <i>MAG</i>					CUTTING INSERT WENDE PLATTE	PRICE / PREIS
		D	Z	d	L	I		
 NEW	AHFM-BN10T3-D16-C16-L100-Z02-H	16	2	16	100	30		107,00 €
	AHFM-BN10T3-D16-C16-L150-Z02-H	16	2	16	150	50		128,00 €
	AHFM-BN10T3-D20-C20-L130-Z03-H	20	3	20	130	40		145,00 €
	AHFM-BN10T3-D20-C20-L130-Z04-H	20	4	20	130	40	BNGX 10T3..	171,00 €
	AHFM-BN10T3-D20-C20-L160-Z03-H	20	3	20	160	80	FOR PRMT	207,00 €
	AHFM-BN10T3-D25-C25-L140-Z04-H	25	4	25	140	50	INSERT.	193,00 €
	AHFM-BN10T3-D25-C25-L140-Z05-H	25	5	25	140	50		220,00 €
	AHFM-BN10T3-D25-C25-L180-Z04-H	25	4	25	180	100		290,00 €
	AHFM-BN10T3-D32-C32-L150-Z05-H	32	5	32	150	70		268,00 €
	AHFM-BN10T3-D32-C32-L150-Z06-H	32	6	32	150	70		295,00 €
-°	AHFM-BN10T3-D35-C32-L200-Z06-H	35	6	32	200	50		388,00 €
	NEW AHFM-BL0603-D16-C15-L150-Z02	16	2	15	150	20		107,00 €
	NEW AHFM-BL0603-D16-C16-L100-Z02-H	16	2	16	100	30		107,00 €
	NEW AHFM-BL0603-D16-C16-L150-Z02	16	2	16	150	50		107,00 €
	NEW AHFM-BL0603-D17-C16-L150-Z02	17	2	16	150	20		107,00 €
	AHFM-BL0603-D17-W16-L170-Z02	17	2	16	170	20		120,00 €
	AHFM-BL0603-D17-W16-L170-Z02-H	17	2	16	170	20		150,00 €
	NEW AHFM-BL0603-D18-C16-L150-Z02	18	2	16	150	20		107,00 €
	AHFM-BL0603-D18-W16-L150-Z02-H	18	2	16	150	20	BLMP 0603..	128,00 €
	NEW AHFM-BL0603-D20-C20-L130-Z03	20	3	20	130	50	FOR TGTC	121,00 €
	NEW AHFM-BL0603-D20-C20-L160-Z03	20	3	20	160	50	INSERT.	141,00 €
	AHFM-BL0603-D21-W20-L200-Z03	21	3	20	200	25		202,00 €
	NEW AHFM-BL0603-D21-C20-L200-Z03	21	3	20	200	25		202,00 €
	NEW AHFM-BL0603-D25-C25-L250-Z04	25	4	25	250	40		334,00 €
	AHFM-BL0603-D26-W25-L200-Z04	26	4	25	200	35		221,00 €
	NEW AHFM-BL0603-D26-C25-L200-Z04	26	4	25	200	35		221,00 €
NEW AHFM-BL0603-D32-C32-L150-Z05	32	5	32	150	70		162,00 €	
NEW AHFM-BL0603-D32-C32-L200-Z05	32	5	32	200	120		244,00 €	
-°	NEW AHFM-BL0603-D33-C32-L200-Z05	33	5	32	200	40		244,00 €
	AHFM-E00602-D10-C10-L080-Z02	10	2	10	80	20		100,00 €
	AHFM-E00602-D10-C09-L120-Z02	10	2	9	120	15		100,00 €
	AHFM-E00602-D10-C10-L120-Z02	10	2	10	120	60		100,00 €
	AHFM-E00602-D12-C12-L080-Z02	12	2	12	80	20	EO.. 0602..	100,00 €
	AHFM-E00602-D12-C12-L080-Z03	12	3	12	80	20	ZOMT 0602..	112,00 €
	AHFM-E00602-D12-C11-L120-Z02	12	2	11	120	15	FOR DJT	100,00 €
	AHFM-E00602-D12-C11-L120-Z03	12	3	11	120	15	INSERT.	112,00 €
	AHFM-E00602-D12-C12-L120-Z02	12	2	12	120	60		100,00 €
	AHFM-E00602-D12-C12-L120-Z03	12	3	12	120	60		112,00 €
-°	AHFM-E00602-D16-C16-L150-Z04	16	4	16	150	60		125,00 €
	AHFM-EP1003-D16-C16-L150-Z02-H	16	2	16	150	50	EP.. 1003..	85,00 €
	AHFM-EP1003-D17-C16-L150-Z02-H	17	2	16	150	20	ZPMT 1003..	85,00 €
	AHFM-EP1003-D20-C20-L150-Z04-H	20	4	20	150	50	YPHW 1003..	117,00 €
	AHFM-EP1003-D21-C20-L150-Z04-H	21	4	20	150	20	FOR DJT	117,00 €
							INSERT.	

S - SYSTEM HIGHFEED END MILLS / S - SYSTEM HOCHGESCHWINDIGKEITS

	CODE / TYP	TOOL DIMENSIONS (mm) <small>MAß</small>					CUTTING INSERT WENDE PLATTE	PRICE / PREIS
		D	Z	d	L	l		
	AHFM-EN1004-D16-C16-L150-Z02	16	2	16	150	25		93,00 €
	AHFM-EN1004-D17-C16-L150-Z02-H	17	2	16	150	25		111,00 €
	AHFM-EN1004-D17-C16-L150-Z02	17	2	16	150	25		93,00 €
	AHFM-EN1004-D17-C16-L200-Z02	17	2	16	200	25		139,00 €
	AHFM-EN1004-D18-C16-L150-Z02	18	2	16	150	25		93,00 €
	AHFM-EN1004-D20-C20-L150-Z03	20	3	20	150	40		111,00 €
	AHFM-EN1004-D21-C20-L150-Z02	21	2	20	150	30	ENMU 1004..	99,00 €
	AHFM-EN1004-D21-C20-L150-Z03	21	3	20	150	30	FOR DJT	111,00 €
	AHFM-EN1004-D21-C20-L200-Z03	21	3	20	200	30	INSERT.	166,00 €
	AHFM-EN1004-D22-C20-L150-Z03	22	3	20	150	30		111,00 €
	AHFM-EN1004-D25-C25-L150-Z03	25	3	25	150	40		111,00 €
	AHFM-EN1004-D25-C25-L150-Z04	25	4	25	150	40		122,00 €
	AHFM-EN1004-D26-C25-L150-Z03	26	3	25	150	30		111,00 €
	AHFM-EN1004-D26-C25-L150-Z04	26	4	25	150	30		122,00 €
	AHFM-EN1004-D26-C25-L200-Z03	26	4	25	200	30		166,00 €
	AHFM-EN1004-D28-C25-L200-Z04	28	4	25	200	30		227,00 €
AHFM-EN1004-D32-C32-L200-Z04	32	4	32	200	50		227,00 €	
AHFM-EN1004-D33-C32-L200-Z04	33	4	32	200	30		227,00 €	
	AHFMC-JD1204-D32-C32-L150-Z02	32	2	32	150	50	JDMW 1204..	158,00 €
	AHFMC-JD1204-D32-C32-L200-Z02	32	2	32	200	50	FOR MTSBSH	209,00 €
	AHFMC-JD1204-D35-C32-L200-Z02	35	2	32	200	50	INSERT.	219,00 €
	AHFMC-JD1204-D35-C32-L250-Z02	35	2	32	250	50		301,00 €
	AHFM-LN120-D16-C15-L150-Z02	16	2	15	150	30	LNMX 1235..	125,00 €
	AHFM-LN120-D21-C20-L150-Z03	21	3	20	150	30	FOR B.OKE	145,00 €
	AHFM-LN120-D26-C25-L150-Z04	26	4	25	150	30	INSERT.	173,00 €
	AHFM-LN120-D33-C32-L200-Z05	33	5	32	200	30		201,00 €
	AHFM-L003-D16-C16-L100-Z02	16	2	16	100	30		103,00 €
	AHFM-L003-D16-C16-L100-Z02-F	16	2	16	100	30		155,00 €
	AHFM-L003-D16-C15-L160-Z02	16	2	15	160	30		125,00 €
	AHFM-L003-D16-C16-L160-Z02	16	2	16	160	50		125,00 €
	AHFM-L003-D17-C16-L180-Z02	17	2	16	180	30	LOGU 0303..	155,00 €
	AHFM-L003-D20-C20-L130-Z03	20	3	20	130	40	FOR KYCR	131,00 €
	AHFM-L003-D20-C20-L160-Z03	20	3	20	160	80	INSERT.	160,00 €
	AHFM-L003-D21-C20-L200-Z03	21	3	20	200	30		203,00 €
	AHFM-L003-D25-C25-L140-Z04	25	4	25	140	50		186,00 €
	AHFM-L003-D25-C25-L140-Z04-F	25	4	25	140	50		279,00 €
	AHFM-L003-D25-C25-L180-Z04	25	4	25	180	100		241,00 €
	AHFM-L003-D32-C32-L200-Z05	32	5	32	200	120		303,00 €

S - SYSTEM HIGHFEED END MILLS / S - SYSTEM HOCHGESCHWINDIGKEITS

	CODE / TYP	TOOL DIMENSIONS (mm) <small>MAG</small>					CUTTING INSERT WENDE PLATTE	PRICE / PREIS
		D	Z	d	L	I		
	AHFM-LP0102-D10-C09-L120-Z02	10	2	9	120	20	LPGT 0102..	119,00 €
	AHFM-LP0102-D10-C10-L120-Z02	10	2	10	120	20	FOR KYCR	119,00 €
	AHFM-LP0102-D12-C11-L120-Z02	12	2	11	120	20	INSERT.	119,00 €
	AHFM-LP0102-D12-C12-L120-Z02	12	2	12	120	20		119,00 €
	NEW AHFM-SD06T2-D16-C16-L150-Z02-H	16	2	16	150	50		120,00 €
	NEW AHFM-SD06T2-D17-C16-L150-Z02-H	17	2	16	150	50	SD.. 06T2..	120,00 €
	NEW AHFM-SD06T2-D20-C20-L150-Z03-H	20	3	20	150	50	FOR ZCC	138,00 €
	NEW AHFM-SD06T2-D21-C20-L150-Z03-H	21	3	20	150	50	INSERT.	138,00 €
	NEW AHFM-SD06T2-D25-C25-L150-Z04-H	25	4	25	150	50		155,00 €
	NEW AHFM-SD06T2-D26-C25-L150-Z04-H	26	4	25	150	60		155,00 €
	AHFMC-SD09T3-D25-C25-L150-Z02	25	2	25	150	100	SD.. 09T3..	117,00 €
	AHFMC-SD09T3-D25-W25-L150-Z02	25	2	25	150	100	FOR ZCC	117,00 €
	AHFMC-SD09T3-D32-C32-L150-Z03	32	3	32	150	100	INSERT.	135,00 €
AHFMC-SD09T3-D32-W32-L150-Z03	32	3	32	150	100		135,00 €	
	AHFM-S00803-D20-W20-L150-Z02	20	2	20	150	50	SOMW 080315	112,00 €
	AHFM-S00803-D25-W25-L150-Z03	25	3	25	150	50	FOR KPTK	122,00 €
	AHFM-S00803-D32-W32-L150-Z04	32	4	32	150	50	INSERT.	133,00 €
	AHFM-SP1004-D25-C25-L150-Z02	25	2	25	150	50	SPNW 1004..	136,00 €
	AHFM-SP1004-D32-C32-L150-Z03	32	3	32	150	50	FOR DJT	156,00 €
	AHFM-Y00602-D10-C09-L120-Z02-F	10	2	9	120	15		171,00 €
	AHFM-Y00602-D10-C10-L080-Z02-F	10	2	10	80	20		171,00 €
	AHFM-Y00602-D10-C10-L120-Z02-F	10	2	10	120	60		171,00 €
	AHFM-Y00602-D10-C10-L120-Z02-H-F	10	2	10	120	60		171,00 €
	AHFM-Y00602-D10-C10-L120-Z02-H	10	2	10	120	60		114,00 €
	AHFM-Y00602-D12-C11-L120-Z02-F	12	2	11	120	15	YOHW 0602..	171,00 €
	AHFM-Y00602-D12-C11-L120-Z02-H-F	12	2	11	120	15	FOR DJT	171,00 €
	AHFM-Y00602-D12-C11-L120-Z02-H	12	2	11	120	15	INSERT.	114,00 €
	AHFM-Y00602-D12-C11-L120-Z03-F	12	3	11	120	15		193,00 €
	AHFM-Y00602-D12-C12-L080-Z02-F	12	2	12	80	20		171,00 €
	AHFM-Y00602-D12-C12-L080-Z03-F	12	3	12	80	20		193,00 €
	AHFM-Y00602-D12-C12-L120-Z02-F	12	2	12	120	60		171,00 €
	AHFM-Y00602-D12-C12-L120-Z03-F	12	3	12	120	60		193,00 €

S - SYSTEM HIGHFEED END MILLS / S - SYSTEM HOCHGESCHWINDIGKEITS

	CODE / TYP	TOOL DIMENSIONS (mm) MAß					CUTTING INSERT WENDE PLATTE	PRICE / PREIS
		D	Z	d	L	I		
 	AHFM-YP1003-D16-C15-L150-Z02-F	16	2	15	150	20		142,00 €
	AHFM-YP1003-D16-C15-L200-Z02-F	16	2	15	200	20		212,00 €
	AHFM-YP1003-D16-C16-L150-Z02-F	16	2	16	150	50		142,00 €
	AHFM-YP1003-D17-C16-L150-Z02-F	17	2	16	150	20		142,00 €
	AHFM-YP1003-D17-C16-L200-Z02-F	17	2	16	200	20		212,00 €
	AHFM-YP1003-D20-C18-L150-Z03-F	20	3	18	150	25	YPHW 1003..	171,00 €
	AHFM-YP1003-D20-C18-L200-Z03-F	20	3	18	200	25	FOR DJT	257,00 €
	AHFM-YP1003-D20-C20-L150-Z03-F	20	3	20	150	50	INSERT.	171,00 €
	AHFM-YP1003-D21-C20-L150-Z03-F	21	3	20	150	20		171,00 €
	AHFM-YP1003-D21-C20-L150-Z04-F	21	3	20	150	20		201,00 €
	AHFM-YP1003-D21-C20-L200-Z03-F	21	3	20	200	20		257,00 €
	AHFM-YP1003-D25-C20-L150-Z04-F	25	4	20	150	25		183,00 €
	AHFM-YP1003-D25-C20-L200-Z04-F	25	4	20	200	25		275,00 €
	AHFM-YP1003-D25-C25-L150-Z04-F	25	4	25	150	50		183,00 €
	AHFM-YP1003-D26-C25-L150-Z04-F	26	4	25	150	30		183,00 €
	AHFM-YP1003-D26-C25-L200-Z03-F	26	3	25	200	30		257,00 €
AHFM-YP1003-D26-C25-L200-Z04-F	26	4	25	200	30		275,00 €	
	AHFM-WD0503D-D20-C20-L150-Z02	20	2	20	150	50	WDMT 0503..	95,00 €
	AHFM-WD0503D-D21-C20-L150-Z02	21	2	20	150	30	FOR DJT INSERT.	117,00 €
	AHFMC-WD06T3D-D26-C25-L200-Z02	26	2	25	200	30	WDHW 06T3..	155,00 €
	AHFMC-WD06T3D-D33-C32-L200-Z03	33	3	32	200	32	FOR DJT INSERT.	179,00 €
	AHFM-WD0603-D16-C16-L150-Z02	16	2	16	150	70	WDMT 0603..	202,00 €
	AHFM-WD0603-D20-C20-L150-Z03	20	3	20	150	70	SMTM	214,00 €
	AHFMC-WD0804-D25-C25-L150-Z02	25	2	25	150	70	WDMT 0804..	154,00 €
	AHFMC-WD0804-D32-C32-L150-Z03	32	3	32	150	70	SMTM	183,00 €
	AHFMC-WD1205-D32-C32-L150-Z02	32	2	32	150	70	WDMT 1205.. FOR SMTM INSERT.	155,00 €
	AHFM-W004T2D-D16-C16-L150-Z02	16	2	16	150	20	WOMW 04T2..	98,00 €
	AHFM-W004T2D-D17-C16-L150-Z02	17	2	16	150	20	FOR DJT INSERT.	102,00 €

S - SYSTEM HIGHFEED END MILLS / S - SYSTEM HOCHGESCHWINDIGKEITS

	CODE / TYP	TOOL DIMENSIONS (mm) <small>MAB</small>					CUTTING INSERT WENDE PLATTE	PRICE / PREIS
		D	Z	d	L	I		
	NEW AHFM-WN0603-D16-C16-L110-Z02-H	16	2	16	110	30		104,00 €
	NEW AHFM-WN0603-D16-C16-L150-Z02-H	16	2	16	150	70	WNMX 0603..	130,00 €
	NEW AHFM-WN0603-D17-C16-L150-Z02-H	17	2	16	150	20	FOR KRLY	130,00 €
	NEW AHFM-WN0603-D20-C20-L150-Z02-H	20	2	20	150	70	INSERT.	135,00 €
	NEW AHFM-WN0603-D20-C20-L200-Z02-H	20	2	20	200	100		189,00 €
	NEW AHFM-WN0603-D21-C20-L150-Z02-H	21	2	20	150	20		135,00 €
	AHFM-WN09T3-D25-W25-L120-Z02-H	25	2	25	120	40		138,00 €
	AHFML-WN09T3-D25-W25-L120-Z02-H	25	2	25	120	40		138,00 €
	AHFM-WN09T3-D25-C25-L200-Z02	25	2	25	200	120		202,00 €
	AHFM-WN09T3-D30-W25-L120-Z03-H	30	3	25	120	30	WNMX 09T3..	156,00 €
	AHFM-WN09T3-D32-W32-L120-Z03-H	32	3	32	120	30	FOR KRLY	156,00 €
	NEW AHFM-WN09T3-D32-W32-L200-Z03-H	32	3	32	200	100	INSERT.	260,00 €
	NEW AHFM-WN09T3-D35-W32-L200-Z04-H	35	4	32	200	50		286,00 €
	AHFM-WN09T3-D40-W32-L120-Z04-H	40	4	32	120	30		174,00 €
	AHFM-WN09T3-D40-C32-L200-Z04	40	4	32	200	30		230,00 €
	NEW AHFM-WN1305-D32-C32-L150-Z02-H	32	2	32	150	70	WNMX 1305..	156,00 €
NEW AHFM-WN1305-D32-C32-L200-Z02-H	32	2	32	200	120	FOR KRLY	260,00 €	
NEW AHFM-WN1305-D40-C32-L200-Z03-H	40	3	32	200	30	INSERT.	313,00 €	

90°
MODULAR END MILLS (SCREW TYPE TOOLS) / EINSCHRAUBFRÄSER

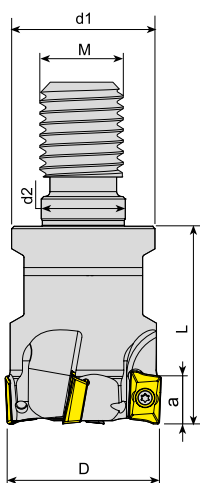
	CODE / TYP	TOOL DIMENSIONS (mm) <small>MAB</small>						CUTTING INSERT WENDE PLATTE	PRICE / PREIS
		D	Z	d ₁	M	L	d ₂		
 	AEM90-AP10-D16-M08-L30-Z02-H	16	2	14.75	M08	30	8.5		91,00 €
	AEM90-AP10-D20-M10-L30-Z03-H	20	3	18	M10	30	10.5		107,00 €
	AEM90-AP10-D25-M12-L35-Z03-H	25	3	21	M12	35	12.5	AP.. 1003..	112,00 €
	AEM90-AP10-D32-M16-L35-Z04-H	32	4	29	M16	35	17	FOR ISO	129,00 €
	AEM90-AP10-D40-M16-L43-Z05-H	40	5	29	M16	43	17	INSERT.	150,00 €
	AEM90-AP10-D42-M16-L43-Z05-H	42	5	29	M16	43	17		150,00 €
	AEM90-AP10D-D16-M08-L30-Z02-H	16	2	14.75	M08	30	8.5	AP.. 1003..	91,00 €
	AEM90-AP10D-D20-M10-L30-Z03-H	20	3	18	M10	30	10.5	FOR DJT	107,00 €
	AEM90-AP10D-D25-M12-L35-Z03-H	25	3	21	M12	35	12.5	INSERT.	112,00 €
	AEM90-AP11-D16-M08-L30-Z02-H	16	2	14.75	M08	30	8.5		91,00 €
	AEM90-AP11-D20-M10-L30-Z03-H	20	3	18	M10	30	10.5	AP.. 11T3..	107,00 €
	AEM90-AP11-D25-M12-L35-Z03-H	25	3	21	M12	35	12.5	FOR ZCC	112,00 €
	AEM90-AP11-D32-M16-L35-Z04-H	32	4	29	M16	35	17	INSERT.	129,00 €
	AEM90-AP11-D40-M16-L43-Z05-H	40	5	29	M16	43	17		148,00 €
	AEM90-AP16-D25-M12-L43-Z02-H	25	2	21	M12	43	12.5	AP.. 1604..	112,00 €
	AEM90-AP16-D32-M16-L43-Z03-H	32	3	29	M16	43	17	FOR ISO	129,00 €
	AEM90-AP16-D40-M16-L43-Z04-H	40	4	29	M16	43	17	INSERT.	150,00 €
	AEM90-AP16-D42-M16-L43-Z04	42	4	29	M16	43	17		150,00 €
	AEM90-AP16D-D25-M12-L43-Z02-H	25	2	21	M12	43	12.5	AP.. 1604..	112,00 €
	AEM90-AP16D-D32-M16-L43-Z03-H	32	3	29	M16	43	17	FOR DJT	129,00 €
AEM90-AP16D-D40-M16-L43-Z04-H	40	4	29	M16	43	17	INSERT.	150,00 €	
AEM90-AP16L-D25-M12-L43-Z02-H	25	2	21	M12	43	12.5	AP.. 1604..	112,00 €	
AEM90-AP16L-D32-M16-L43-Z03-H	32	3	29	M16	43	17	FOR LMNA	129,00 €	
AEM90-AP16L-D40-M16-L43-Z04-H	40	4	29	M16	43	17	INSERT.	150,00 €	

90°





MODULAR END MILLS (SCREW TYPE TOOLS) / EINSCHRAUBFRÄSER

	CODE / TYP	TOOL DIMENSIONS (mm) <small>MAß</small>						CUTTING INSERT <small>WENDE PLATTE</small>	PRICE / PREIS
		D	Z	d ₁	M	L	d ₂		
 90°	AEM90-A01236-D16-M08-L30-Z02	16	2	14.8	M08	30	8.5	AO.. 1236..	130,00 €
	AEM90-A01236-D20-M10-L35-Z03	20	3	18	M10	35	10.5	FOR MTSBH INSERT.	153,00 €
 90°	AEM90-AD1505D-D25-M12-L43-Z02-H	25	2	21	M12	43	12.5	ADKT 150508	132,00 €
	AEM90-AD1505D-D32-M16-L43-Z03-H	32	3	29	M16	43	17	FOR DJT INSERT.	144,00 €
 90°	AEM90-AX1235-D16-M08-L30-Z02-H	16	2	14.75	M08	30	8.5	AX.T 1235..	118,00 €
	AEM90-AX1235-D20-M10-L30-Z03-H	20	3	18	M10	30	10.5	FOR SMTM	135,00 €
	AEM90-AX1235-D25-M12-L35-Z04-H	25	4	21	M12	35	12.5	INSERT.	158,00 €
	AEM90-AX1705-D25-M12-L43-Z02-H	25	2	21	M12	43	12.5	AX.T 1705..	142,00 €
	AEM90-AX1705-D32-M16-L43-Z02-H	32	2	29	M16	43	17	FOR SMTM INSERT.	154,00 €
 90°	AEM90-DC07-D20-M10-L30-Z02-H	20	2	18	M10	30	10.5	DC.T 0702..	107,00 €
	AEM90-DC07-D25-M12-L35-Z03-H	25	3	21	M12	35	12.5	FOR ISO	122,00 €
	AEM90-DC07-D32-M16-L43-Z04-H	32	4	29	M16	43	17	INSERT.	138,00 €
	AEM90-DC07-D40-M16-L43-Z05-H	40	5	29	M16	43	17		148,00 €
	AEM90-DC11-D32-M16-L43-Z03-H-F	32	3	29	M16	43	17	DC.T 11T3..	224,00 €
	AEM90-DC11-D40-M16-L43-Z03-H-F	40	3	29	M16	43	17	FOR ISO INSERT.	224,00 €
 90°	AEM90-R390.11-D16-M08-L30-Z02-H	16	2	14.75	M08	30	8.5	R390-11T3..	112,00 €
	AEM90-R390.11-D20-M10-L30-Z03-H	20	3	18	M10	30	10.5	FOR SNDVK	129,00 €
	AEM90-R390.11-D25-M12-L35-Z03-H	25	3	21	M12	35	12.5	INSERT.	135,00 €
	AEM90-R390.11-D32-M16-L43-Z04-H	32	4	29	M16	43	17		146,00 €
 90°	AEM90-RT10-D16-M08-L20-Z02-H	16	2	14.75	M08	20	8.5	RT 1003..	110,00 €
	AEM90-RT10-D20-M10-L25-Z03-H	20	3	18	M10	25	10.5	FOR SFTY	125,00 €
	AEM90-RT10-D25-M12-L30-Z04-H	25	4	21	M12	30	12.5	INSERT.	129,00 €
	AEM90-RT10-D32-M16-L43-Z05-H	32	5	29	M16	43	17		145,00 €
	AEM90-RT10-D42-M16-L43-Z06-H	42	6	29	M16	43	17		166,00 €

MODULAR END MILLS (SCREW TYPE TOOLS) / EINSCHRAUBFRÄSER

	CODE / TYP	TOOL DIMENSIONS (mm) <small>MAß</small>						CUTTING INSERT <small>WENDE PLATTE</small>	PRICE / PREIS
		D	Z	d ₁	M	L	d ₂		
 90°	AEM90-WN0604Z-D25-M12-L35-Z02-H	25	2	21	M12	35	12.5	WNHU 0604..	132,00 €
	AEM90-WN0604Z-D32-M16-L43-Z03-H	32	3	29	M16	43	17	FOR ZCC	145,00 €
	AEM90-WN0604Z-D40-M16-L43-Z04-H	40	4	29	M16	43	17	INSERT.	165,00 €
 95°	AEM95-XD0206-D16-M08-L23-Z02-H	16	2	14.75	M08	23	8.5		91,00 €
	AEM95-XD0206-D16-M08-L23-Z02-H-F	16	2	14.75	M08	23	8.5	XDHW 0206..	137,00 €
	AEM95-XD0206-D20-M10-L30-Z03-H	20	3	18	M10	30	10.5	FOR DJT	107,00 €
	AEM95-XD0206-D20-M10-L30-Z03-H-F	20	3	18	M10	30	10.5	INSERT.	161,00 €
	AEM95-XD0206-D25-M12-L35-Z03-H	25	3	21	M12	35	12.5		112,00 €
	AEM95-XD0206-D25-M12-L35-Z03-H-F	25	3	21	M12	35	12.5		168,00 €
	AEM95C-XD0310-D35-M16-L43-Z03-H	35	3	29	M16	43	17		129,00 €
	AEM95C-XD0310-D35-M16-L43-Z03-H-F	35	3	29	M16	43	17	XDHW 0310..	193,00 €
	AEM95C-XD0310-D42-M16-L43-Z04-H	42	4	29	M16	43	17	FOR DJT	150,00 €
	AEM95C-XD0310-D42-M16-L43-Z04-H-F	42	4	29	M16	43	17	INSERT.	225,00 €
 -°	AEMR-RC10T3-D25-M12-L35-Z03-H	25	3	21	M12	35	12.5	RC. 10T3..	134,00 €
	AEMR-RC10T3-D32-M16-L43-Z04-H	32	4	29	M16	43	17	FOR ZCC	148,00 €
	AEMR-RC10T3-D40-M16-L43-Z05-H	40	5	29	M16	43	17	INSERT.	164,00 €
 -°	AEMR-RP08T2M-D20-M10-L30-Z02-H	20	2	18	M10	30	10.5	RPMT 08T2..	123,00 €
	AEMR-RP10T3M-D25-M12-L35-Z02-H	25	2	21	M12	35	12.5	RPMT 10T3..	128,00 €
	AEMR-RP10T3M-D32-M16-L43-Z03-H	32	3	29	M16	43	17	MTSBSH	144,00 €
	AEMR-RP1204M-D32-M16-L43-Z03-H	32	3	29	M16	43	17	RPMT 1204..	144,00 €
	AEMR-RP1204M-D40-M16-L43-Z04-H	40	4	29	M16	43	17	FOR MTSBSH	164,00 €
								INSERT.	
 -°	AEMR-RP10T3-D25-M12-L35-Z02-H	25	2	21	M12	35	12.5	RPNX 10T3..	139,00 €
	AEMR-RP10T3-D32-M16-L43-Z03-H	32	3	29	M16	43	17	FOR CRTZT	154,00 €
							INSERT.		

MODULAR END MILLS (SCREW TYPE TOOLS) / EINSCHRAUBFRÄSER

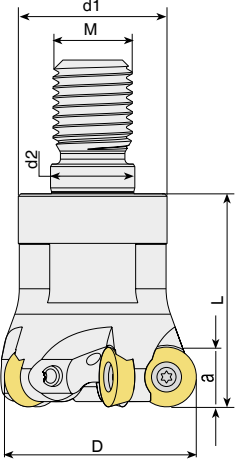
	CODE / TYP	TOOL DIMENSIONS (mm) <small>MAß</small>						CUTTING INSERT <small>WENDE PLATTE</small>	PRICE / PREIS
		D	Z	d ₁	M	L	d ₂		
 	AEMR-RY10-D32-M16-L43-Z04-H	32	4	29	M16	43	17	RYMX 1004..	169,00 €
	AEMR-RY10-D40-M16-L43-Z05-H	40	5	29	M16	43	17	FOR TGTC INSERT.	186,00 €
	AEMR-RY12-D32-M16-L43-Z03-H	32	3	29	M16	43	17	RYMX 1205..	153,00 €
	AEMR-RY12-D40-M16-L43-Z03-H	40	3	29	M16	43	17	FOR TGTC INSERT.	166,00 €
  	AEMR-RD07T1-D12-M07-L23-Z02-H	12	2	10	M07	23	6.5	RD.. 07T1	91,00 €
	AEMR-RD0702-D15-M08-L23-Z02-H	15	2	13	M08	23	8.5		91,00 €
	AEMR-RD0702-D16-M08-L23-Z02-H	16	2	13	M08	23	8.5		91,00 €
	AEMR-RD0702-D20-M10-L30-Z04-H	20	4	18	M10	30	10.5		112,00 €
	AEMR-RD0702-D25-M12-L35-Z05-H	25	5	21	M12	35	12.5	RD.. 0702	129,00 €
	AEMR-RD0702-D30-M16-L42-Z05-H	30	5	29	M16	42	17	ISO	140,00 €
	AEMR-RD0702-D32-M16-L43-Z05-H	32	5	29	M16	43	17		140,00 €
	AEMR-RD0702-D35-M16-L42-Z06-H	35	6	29	M16	42	17		150,00 €
	AEMR-RD0702-D42-M16-L43-Z05-H	42	5	29	M16	43	17		154,00 €
	AEMR-RD0702-D42-M16-L43-Z07-H	42	7	29	M16	43	17		173,00 €
	AEMR-RD08T2-D16-M08-L23-Z02-H	16	2	13	M08	23	8.5		108,00 €
	AEMR-RD08T2-D16-M10-L23-Z02-H	16	2	13	M10	23	10.5	RD.. 08T2	108,00 €
	AEMR-RD08T2-D20-M10-L30-Z03-H	20	3	18	M10	30	10.5	ISO	122,00 €
	AEMR-RD08T2-D25-M12-L35-Z04-H	25	4	21	M12	35	12.5		136,00 €
	AEMR-RD0803-D16-M08-L23-Z02-H	16	2	13	M08	23	8.5		108,00 €
	AEMR-RD0803-D20-M10-L30-Z03-H	20	3	18	M10	30	10.5	RD.. 0803	122,00 €
	AEMR-RD0803-D25-M12-L35-Z04-H	25	4	21	M12	35	12.5	ISO	136,00 €
	AEMR-RD1003-D20-M10-L30-Z02-H	20	2	18	M10	30	10.5		97,00 €
	AEMR-RD1003-D25-M12-L35-Z02-H	25	2	21	M12	35	12.5		107,00 €
	AEMR-RD1003-D25-M12-L35-Z03-H	25	3	21	M12	35	12.5		112,00 €
	AEMR-RD1003-D30-M16-L43-Z04-H	30	4	29	M16	43	17		129,00 €
	AEMR-RD1003-D32-M16-L43-Z04-H	32	4	29	M16	43	17	RD.. 1003	129,00 €
	AEMR-RD1003-D35-M16-L43-Z04-H	35	4	29	M16	43	17	ISO	134,00 €
	AEMR-RD1003-D40-M16-L43-Z05-H	40	5	29	M16	43	17		150,00 €
	AEMR-RD1003-D42-M16-L43-Z05-H	42	5	29	M16	43	17		150,00 €
	AEMR-RD12T3-D24-M12-L35-Z02-H	24	2	21	M12	35	12.5		107,00 €
	AEMR-RD12T3-D25-M12-L35-Z02-H	25	2	21	M12	35	12.5		107,00 €
	AEMR-RD12T3-D32-M16-L43-Z03-H	32	3	29	M16	43	17		129,00 €
	AEMR-RD12T3-D35-M16-L43-Z03-H	35	3	29	M16	43	17	RD.. 12T3	134,00 €
	AEMR-RD12T3-D35-M16-L43-Z04-H	35	4	29	M16	43	17	ISO	150,00 €
	AEMR-RD12T3-D40-M16-L43-Z04-H	40	4	29	M16	43	17		150,00 €
	AEMR-RD12T3-D42-M16-L43-Z05-H	42	5	29	M16	43	17		166,00 €
AEMR-RD1204-D32-M16-L43-Z03-H	32	3	29	M16	43	17	RD.. 1204	129,00 €	
AEMR-RD1204-D42-M16-L43-Z04-H	42	4	29	M16	43	17	ISO	150,00 €	
AEMR-RD1604-D32-M16-L43-Z02-H	32	2	29	M16	43	17	RD.. 1604	145,00 €	
AEMR-RD1604-D40-M16-L43-Z02-H	40	2	29	M16	43	17	ISO	150,00 €	
AEMR-RD1604-D42-M16-L43-Z03-H	42	3	29	M16	43	17		166,00 €	

MODULAR END MILLS (SCREW TYPE TOOLS) / EINSCHRAUBFRÄSER

	CODE / TYP	TOOL DIMENSIONS (mm) <i>MAß</i>						CUTTING INSERT WENDE PLATTE	PRICE / PREIS
		D	Z	d ₁	M	L	d ₂		
	AEMR-QP10T3-D25-M12-L35-Z02-H	25	2	21	M12	35	12.5	QP. 10T3..	154,00 €
	AEMR-QP10T3-D32-M16-L43-Z03-H	32	3	29	M16	43	17	FOR SMTM INSERT.	170,00 €

S - SYSTEM MODULAR (SCREW TYPE) HIGHFEED END MILLS / SYSTEM HOCHGESCHWINDIGKEITS - EINSCHRAUBFRÄSER

	CODE / TYP	TOOL DIMENSIONS (mm) <i>MAß</i>						CUTTING INSERT WENDE PLATTE	PRICE / PREIS
		D	Z	d ₁	M	L	d ₂		
	AHFM-BL0603-D32-M16-L40-Z05-H	32	5	29	M16	40	17	BLMP 0603	151,00 €
	NEW AHFM-BL0904-D32-M16-L40-Z04-H	32	4	29	M16	40	17	BLMP 0904	151,00 €
	AHFM-BL0904-D42-M16-L43-Z05-H	42	5	29	M16	43	17	FOR TGTC INSERT.	164,00 €
	AHFM-ED0702-D12-M06-L20-Z03	12	3	10	M06	20	6.5	EDMT 0702	126,00 €
	AHFM-ED0702-D16-M08-L25-Z04-H	16	4	14.75	M08	25	8.5	JDMT 070204	146,00 €
	AHFM-ED0702-D20-M10-L30-Z05-H	20	5	18	M10	30	10.5	FOR HTCH	166,00 €
	AHFM-ED0702-D25-M12-L30-Z06-H	25	6	21	M12	30	12.5	INSERT.	190,00 €
	AHFM-ED0702-D32-M16-L30-Z08-H	32	8	29	M16	30	17		230,00 €
	AHFM-EP1003-D16-M08-L23-Z02-H	16	2	14.75	M08	23	8.5	EP. 1003..	106,00 €
	AHFM-EP1003-D20-M10-L30-Z04-H	20	4	18	M10	30	10.5	ZPMT 1003..	134,00 €
	AHFM-EP1003-D25-M12-L35-Z04-H	25	4	21	M12	35	12.5	YPHW 1003..	152,00 €
	AHFM-EP1003-D32-M16-L43-Z05-H	32	5	29	M16	43	17	FOR DJT	163,00 €
	AHFM-EP1003-D35-M16-L43-Z05-H	35	5	29	M16	43	17	INSERT.	163,00 €
	AHFM-EP1003-D42-M16-L43-Z06-H	42	6	29	M16	43	17		166,00 €
	AHFM-EN1004-D16-M08-L23-Z02-H	16	2	14.75	M8	23	8.5		117,00 €
	AHFM-EN1004-D20-M10-L30-Z03-H	20	3	18	M10	30	10.5		134,00 €
	AHFM-EN1004-D25-M12-L35-Z03-H	25	3	21	M12	35	12.5	ENMU 1004..	140,00 €
	AHFM-EN1004-D25-M12-L35-Z04-H	25	4	21	M12	35	12.5	FOR DJT	154,00 €
	AHFM-EN1004-D32-M16-L43-Z05-H	32	5	29	M16	43	17	INSERT.	168,00 €
	AHFM-EN1004-D35-M16-L43-Z05-H	35	5	29	M16	43	17		168,00 €
	AHFM-EN1004-D40-M16-L43-Z05-H	40	5	29	M16	43	17		168,00 €
	AHFM-EN1004-D42-M16-L43-Z05-H	42	5	29	M16	43	17		168,00 €
	AHFM-LN120-D25-M12-L35-Z04-H	25	4	21	M12	35	12.5	LNMX 1235..	182,00 €
	AHFM-LN120-D32-M16-L43-Z05-H	32	5	29	M16	43	17	FOR B.OKE	213,00 €
	AHFM-LN120-D42-M16-L43-Z06-H	42	6	29	M16	43	17	INSERT.	241,00 €

S - SYSTEM MODULAR (SCREW TYPE) HIGHFEED END MILLS / SYSTEM HOCHGESCHWINDIGKEITS - EINSCHRAUBFRÄSER 88/89

	CODE / TYP	TOOL DIMENSIONS (mm) <small>MAß</small>						CUTTING INSERT <small>WENDE PLATTE</small>	PRICE / PREIS
		D	Z	d ₁	M	L	d ₂		
 NEW	AHFM-L003-D20-M10-L30-Z04-H-F	20	4	18	M10	30	10.5		248,00 €
	AHFM-L003-D25-M12-L35-Z04-H-F	25	4	21	M12	35	12.5		248,00 €
	AHFM-L003-D25-M12-L35-Z04-H	25	4	21	M12	35	12.5	LOGU 0303..	165,00 €
	AHFM-L003-D32-M16-L40-Z05-H-F	32	5	29	M16	40	17	FOR KYCR	296,00 €
	AHFM-L003-D32-M16-L40-Z05-H	32	5	29	M16	40	17	INSERT.	196,00 €
	AHFM-L003-D32-M16-L40-Z06-H-F	32	6	29	M16	40	17		320,00 €
	AHFM-L003-D32-M16-L40-Z06-H	32	6	29	M16	40	17		213,00 €
	AHFM-L003-D42-M16-L40-Z05-H	42	5	29	M16	40	17		244,00 €
	AHFM-L003-D42-M16-L40-Z06-H	42	6	29	M16	40	17		272,00 €
	AHFMC-JD1204-D32-M16-L43-Z02-H	32	2	29	M16	43	17	JDMW 1204..	158,00 €
	AHFMC-JD1204-D42-M16-L43-Z03-H	42	3	29	M16	43	17	FOR MTSBH	199,00 €
								INSERT.	
 NEW	AHFM-SD06T2-D16-M08-L23-Z02-H	16	2	14.75	M08	23	8.5	SD.. 06T2..	134,00 €
	AHFM-SD06T2-D20-M10-L30-Z03-H	20	3	18	M10	30	10.5	FOR ZCC	153,00 €
	AHFM-SD06T2-D25-M12-L35-Z04-H	25	4	21	M12	35	12.5	INSERT.	177,00 €
	AHFMC-SD09T3-D25-M12-L30-Z02-H	25	2	22	M12	30	12.5	SD.. 09T3..	143,00 €
	AHFMC-SD09T3-D32-M16-L43-Z03-H	32	3	29	M16	43	17	FOR ZCC	182,00 €
	AHFMC-SD09T3-D35-M16-L43-Z03-H	35	3	29	M16	43	17	INSERT.	182,00 €
	AHFMC-SD09T3-D40-M16-L43-Z04-H	40	4	29	M16	43	17		198,00 €
	AHFMC-SD1204-D32-M16-L43-Z02-H	32	2	29	M16	43	17	SD.. 1204..	151,00 €
AHFMC-SD1204-D40-M16-L43-Z03-H	40	3	29	M16	43	17	FOR ZCC INSERT.	175,00 €	
	AHFM-S00803-D20-M10-L30-Z02-H	20	2	18	M10	30	10.5		122,00 €
	AHFM-S00803-D25-M12-L35-Z03-H	25	3	22	M12	35	12.5	SOMW 080315	138,00 €
	AHFM-S00803-D32-M16-L43-Z03-H	32	3	29	M16	43	17	FOR KPTK	138,00 €
	AHFM-S00803-D32-M16-L43-Z04-H	32	4	29	M16	43	17	INSERT.	148,00 €
	AHFM-S00803-D40-M16-L43-Z04-H	40	4	29	M16	43	17		148,00 €
 NEW	AHFM-SO1004-D32-M16-L40-Z03-H	32	3	29	M16	40	17	SOMT 1004..	182,00 €
	AHFM-SO1004-D40-M16-L40-Z04-H	40	4	29	M16	40	17	FOR KYCR	198,00 €
	AHFM-SO1004-D42-M16-L40-Z04-H	42	4	29	M16	40	17	INSERT.	198,00 €
 NEW	AHFM-SP1004-D32-M16-L43-Z03-H	32	3	29	M16	43	17	SPNW 1004..	182,00 €
	AHFM-SP1004-D35-M16-L43-Z03-H	35	3	29	M16	43	17	FOR DJT	182,00 €
	AHFM-SP1004-D42-M16-L43-Z04-H	42	4	29	M16	43	17	INSERT.	198,00 €

S - SYSTEM MODULAR (SCREW TYPE) HIGHFEED END MILLS / SYSTEM HOCHGESCHWINDIGKEITS - EINSCHRAUBFRÄSER

	CODE / TYP	TOOL DIMENSIONS (mm) <i>MAß</i>						CUTTING INSERT <i>WENDE PLATTE</i>	PRICE / PREIS
		D	Z	d ₁	M	L	d ₂		
 NEW	AHFM-YP1003-D16-M08-L23-Z02-F	16	2	14.75	M08	23	8.5		175,00 €
	AHFM-YP1003-D16-M08-L23-Z02-H-F	16	2	14.75	M08	23	8.5		175,00 €
	AHFM-YP1003-D17-M08-L23-Z02-H-F	17	2	14.75	M08	23	8.5		175,00 €
	AHFM-YP1003-D20-M10-L30-Z03-H-F	20	3	18	M10	30	10.5		200,00 €
	AHFM-YP1003-D20-M10-L30-Z04-F	20	4	18	M10	30	10.5	YPHW 1003..	225,00 €
	AHFM-YP1003-D21-M10-L30-Z03-H-F	21	3	18	M10	30	10.5	FOR DJT	200,00 €
	AHFM-YP1003-D25-M12-L35-Z04-F	25	4	21	M12	35	12.5	INSERT.	225,00 €
	AHFM-YP1003-D25-M12-L35-Z04-H-F	25	4	21	M12	35	12.5		225,00 €
	AHFM-YP1003-D26-M12-L35-Z04-H-F	26	4	21	M12	35	12.5		225,00 €
	AHFM-YP1003-D32-M16-L30-Z05-F	32	5	29	M16	30	17		250,00 €
	AHFM-YP1003-D32-M16-L43-Z05-H-F	32	5	29	M16	43	17		250,00 €
	AHFM-YP1003-D40-M16-L43-Z06-H-F	40	6	29	M16	43	17		271,00 €
	AHFM-YP1003-D42-M16-L43-Z06-H-F	42	6	29	M16	43	17		271,00 €
	AHFMC-WD0804-D25-M12-L35-Z02-H	25	2	21	M12	35	12.5	WDMT 0804..	170,00 €
	AHFMC-WD0804-D32-M16-L35-Z03-H	32	3	29	M16	35	17	FOR SMTM	200,00 €
								INSERT.	
	AHFM-WD0503D-D20-M10-L30-Z02-H	20	2	18	M10	30	10.5	WDMT 0503..	143,00 €
	AHFM-WD0503D-D25-M12-L35-Z03-H	25	3	21	M12	35	12.5	FOR DJT	159,00 €
	AHFM-WD0503D-D32-M16-L43-Z04-H	32	4	29	M16	43	17	INSERT.	182,00 €
	AHFM-WD0503D-D40-M16-L43-Z05-H	40	5	29	M16	43	17		190,00 €
	AHFMC-WD06T3D-D35-M16-L43-Z03-H	35	3	29	M16	43	17	WDHW 06T3..	175,00 €
	AHFMC-WD0805D-D32-M16-L43-Z02-H	32	2	29	M16	43	17	WDHW 0805..	261,00 €
	AHFM-WN09T3-D32-M16-L40-Z03-H	32	3	29	M16	40	17	WNMX 09T3..	138,00 €
	AHFM-WN09T3-D40-M16-L40-Z04-H	40	4	29	M16	40	17	FOR KRLY	155,00 €
								INSERT.	

Cutting Calculation : P 114 / Schnittdatenberechnung : S 114

Ordering Example/Beispiel Bestellformular: 1pcs. AHFM-YP1003-D16-M08-L23-Z02-F



PROFILE MILLING TOOLS / KUGEL - KOPIERFRÄSER



90/91

	CODE / TYP	CUTTING INSERT WENDE PLATTE	PRICE / PREIS
 	APMR-BNM12-D12-C12-L130	BNM 120-S	134,00 €
	APMR-BNM16-D16-C16-L175	BNM 160-S	124,00 €
		FOR DJT INSERT.	
	APMR-P3208-D08-C10-L110	P3208 - WLTR	122,00 €
	APMR-P3210-D10-C10-L130	P3210 - WLTR	122,00 €
	APMR-P3210-D10-C12-L130	P3210 - WLTR	122,00 €
	APMR-P3212-D12-C12-L130	P3212 - WLTR	122,00 €
	APMR-P3216-D16-C16-L175	P3216 - WLTR	112,00 €
	APMR-P3220-D20-C20-L200	P3220 - WLTR	122,00 €
	APMR-P3225-D25-C25-L200	P3225 - WLTR	132,00 €
	APMR-P3232-D32-C32-L200	P3232 - WLTR	136,00 €
	FOR WLTR INSERT.		
	APMR-R012-D12-C12-L120	ROHX 1203	108,00 €
	APMR-R012-D12-C16-L160	ZCC	112,00 €
	APMR-R016-D16-C16-L160	ROHX 1604	112,00 €
	APMR-R016-D16-C16-L200	FOR ZCC	122,00 €
	APMR-R016-D16-C20-L200	INSERT.	122,00 €
	APMR-R020-D20-C20-L160	ROHX 2005	116,00 €
	APMR-R020-D20-C20-L200	FOR ZCC	130,00 €
APMR-R020-D20-C25-L220	INSERT.	136,00 €	
	APMR-XP16-D16-C16-L150	XPHT 16R0803	112,00 €
	APMR-XP20-D20-C20-L150	XPHT 20R10T3	116,00 €
	APMR-XP25-D25-C25-L150	XPHT 25R1204	124,00 €
		FOR ZCC INSERT.	



BALL NOSE MODULAR (SCREW TYPE) END MILLS / EINSCHRAUB - KUGELFRÄSER

	CODE / TYP	CUTTING INSERT WENDE PLATTE	PRICE / PREIS
	APMR-P3216-D16-M08-L25	P3216 - WLTR	128,00 €
	APMR-P3220-D20-M10-L30	P3220 - WLTR	134,00 €
	APMR-P3225-D25-M12-L35	P3225 - WLTR	144,00 €
	APMR-P3232-D32-M16-L43	P3232 - WLTR	149,00 €
		FOR WLTR INSERT.	

BALL NOSE MODULAR (SCREW TYPE) END MILLS / EINSCHRAUB - KUGELFRÄSER

	CODE / TYP	CUTTING INSERT WENDE PLATTE	PRICE / PREIS
	APMR-XP16-D16-M08-L25	XPHT 16R0803	138,00 €
	APMR-XP20-D20-M10-L30	XPHT 20R10T3	147,00 €
	APMR-XP25-D25-M12-L40	XPHT 25R1204	156,00 €
		FOR ZCC INSERT.	
	APMR-SWB225-D25-M12-L35	SWB225HM-HS	170,00 €
	APMR-SWB230-D30-M16-L43	SWB230HM-HS	173,00 €
	APMR-SWB232-D32-M16-L43	SWB232HM-HS	175,00 €
		FOR DJT INSERT.	

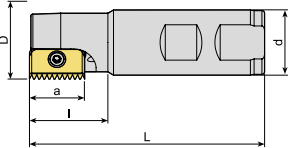
THREAD MILLING TOOLS / GEWINDEFÄSWERKZEUGE

	CODE / TYP	TOOL DIMENSIONS (mm) MAß						CUTTING INSERT WENDE PLATTE	PRICE / PREIS	
		D	Z	d	L	l	a			
 	ATM-C14-D14-W20-L100-Z01-H	14	1	20	100	25	14	C14	102,00 €	
	ATM-C21-D18-W20-L100-Z01-H	18	1	20	100	30	21		123,00 €	
	ATM-C21-D21-W25-L125-Z01-H	21	1	25	125	40	21		134,00 €	
	ATM-C21-D25-W20-L125-Z01-H	25	1	20	125	30	21	C21	134,00 €	
	ATM-C21-D28-W25-L90-Z01-H	28	1	25	90	30	21	FOR CPT	168,00 €	
	NEW ATM-C21-D38-W32-L90-Z03-H	38	3	32	90	21	31	INSERT.	185,00 €	
	ATM-C21-D38-W32-L120-Z03-H	38	3	32	120	30	21		185,00 €	
	ATM-C21-D43-W32-L90-Z03-H	43	3	32	90	30	21		199,00 €	
	ATM-C30-D29-W25-L150-Z01-H	29	1	25	150	50	30	C30	194,00 €	
								FOR CPT INSERT.		
	ATM-H23-D23-C25-L100-Z02-H	23	2	25	100	30	27	H23	219,00 €	
	ATM-H32-D32-C32-L130-Z05-H	32	5	32	130	35	32	H32	255,00 €	
							FOR CPT INSERT.			
	ATM60-TB0601-D13-C10-L150-Z02-H	60	13	10	2.5	150	40	3.3	TBGT 060102	131,00 €
	ATM60-TC0902-D20.5-C16-L150-Z02-H	60	20.5	16	5.2	150	40	4.7	TC.T 090202	131,00 €
	ATM60-TC1102-D26-C20-L150-Z03-H	60	26	20	8.3	150	50	5.4	TC.T 110202	153,00 €
	ATM60-TC16T3-D32-C25-L150-Z02-H	60	32	25	6.4	150	50	8	TC.T 16T304	161,00 €
	ATM60-TC16T3-D40-C32-L250-Z03-H	60	40	32	13.7	250	50	8	ISO	230,00 €



SCREWED TOOL HOLDERS / AUFNAHME FÜR EINSCHRAUBFRÄSER

	CODE / TYP	TOOL DIMENSIONS (mm) MAß						PRICE / PREIS
		d	M	d ₁	D	L	l	
	AVTT-D13-C16-M08-L100-H	16	8	8.5	13	100	40	102,00 €
	AVTT-D15-C16-M08-L130-H	16	8	8.5	15	130	70	112,00 €
	AVTT-D18-C20-M10-L130-H	20	10	10.5	18	130	70	112,00 €
	AVTT-D18-C20-M10-L160-H	20	10	10.5	18	160	80	123,00 €
	AVTT-D23-C25-M12-L150-H	25	12	12.5	23	150	70	134,00 €
	AVTT-D23-C25-M12-L200-H	25	12	12.5	23	200	100	174,00 €
	AVTT-D23-C25-M12-L250-H	25	12	12.5	23	250	150	209,00 €
	AVTT-D30-C32-M16-L150-H	32	16	17	30	150	70	138,00 €
	AVTT-D30-C32-M16-L200-H	32	16	17	30	200	100	179,00 €
	AVTT-D30-C32-M16-L250-H	32	16	17	30	250	150	215,00 €
	AVTT-D30-C32-M16-L300-H	32	16	17	30	300	200	241,00 €

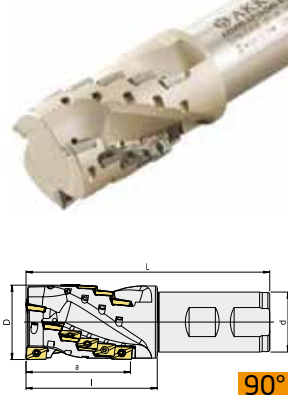
HELIX END MILL / WP - IGELFRÄSER

	CODE / TYP	TOOL DIMENSIONS (mm) MAß						CUTTING INSERT WENDE PLATTE	PRICE / PREIS
		D	z	d	a	l	L		
	AHM90-AP10-D20-W20-L087-Z04	20	4	20	28	37	87		270,00 €
	AHM90-AP10-D20-W20-L087-Z0206	20	2	20	28	37	87	AP.. 1003..	300,00 €
	AHM90-AP10-D25-W25-L105-Z0208-H	25	2	25	37	47	105	ISO	360,00 €
	AHM90-AP10-D32-W32-L115-Z0315-H	32	3	32	46	55	115		485,00 €
	AHM90-AP10-D40-W32-L130-Z0318-H	40	3	32	55	64	130		550,00 €

FACE MILLING TOOLS / PLAN UND ECKMESSERKÖPFE

	CODE / TYP	TOOL DIMENSIONS (mm) MAß					CUTTING INSERT WENDE PLATTE	PRICE / PREIS
		D	z	d	L	a		
	AFM42C-XD0806-D063-A27-Z04-H	63	4	27	50	12		182,00 €
	AFM42C-XD0806-D080-A27-Z05-H	80	5	27	50	12	XDMW 0806..	219,00 €
	AFM42C-XD0806-D100-A32-Z06-H	100	6	32	63	12	FOR DJT	250,00 €
	AFM42C-XD0806-D125-B40-Z07	125	7	40	63	12	INSERT.	328,00 €
	AFM42C-XD0806-D160-C40-Z08	160	8	40	63	12		401,00 €
	AFM42C-XD0806-D200-C60-Z09	200	9	60	63	12		601,00 €
	AFM43-OD0504-D040-A16-Z04-H	40	4	16	40	3.5		102,00 €
	AFM43-OD0504-D050-A22-Z05-H	50	5	22	40	3.5	OD.. 0504..	122,00 €
	AFM43-OD0504-D063-A22-Z06-H	63	6	22	40	3.5	FOR WLTR	143,00 €
	AFM43-OD0504-D080-A27-Z07-H	80	7	27	50	3.5	INSERT.	163,00 €
	AFM43-OD0504-D100-A32-Z08-H	100	8	32	50	3.5		205,00 €

FACE MILLING TOOLS / PLAN UND ECKMESSERKÖPFE

	CODE / TYP	TOOL DIMENSIONS (mm) <small>MAß</small>					CUTTING INSERT <small>WENDE PLATTE</small>	PRICE / PREIS
		D	z	d	L	a		
 43°	AFM43C-OD0605-D080-A27-Z06-H	80	6	27	50	4	OD.. 0605..	221,00 €
	AFM43C-OD0605-D100-A32-Z07-H	100	7	32	50	4	FOR WLTR-LMNA	248,00 €
	AFM43C-OD0605-D125-B40-Z08	125	8	40	63	4	INSERT.	326,00 €
 43°	AFM43-OF05T3-D050-A22-Z05-H	50	5	22	40	3	OF.. 05T3..	138,00 €
	AFM43-OF05T3-D063-A22-Z06-H	63	6	22	40	3	ISO	158,00 €
	AFM43-OF05T3-D080-A27-Z07-H	80	7	27	50	3		179,00 €
	AFM43-OF05T3-D125-B40-Z09	125	9	40	63	3		362,00 €
 43°	AFM43-ON0604-D050-A22-Z05-H	50	5	22	40	4	ON.. 0604..	144,00 €
	AFM43-ON0604-D063-A22-Z06-H	63	6	22	40	4		168,00 €
	AFM43-ON0604-D080-A27-Z07-H	80	7	27	50	4	FOR ZCC	195,00 €
	AFM43-ON0604-D100-A32-Z08-H	100	8	32	50	4	INSERT.	245,00 €
	AFM43-ON0604-D125-B40-Z09	125	9	40	63	4		326,00 €
 44°	AFM44-ON0606-D063-A22-Z06-H	63	6	22	40	3.8	ONHX 0606..	168,00 €
	AFM44-ON0606-D080-A27-Z08-H	80	8	27	50	3.8	FOR PLBT	195,00 €
	AFM44-ON0606-D100-A32-Z10-H	100	10	32	50	3.8	INSERT.	245,00 €
 45°	AFM45-HN0905-D050-A22-Z05-H	50	5	22	40	4.5		188,00 €
	AFM45-HN0905-D063-A22-Z06-H	63	6	22	40	4.5		211,00 €
	AFM45-HN0905-D080-A27-Z07-H	80	7	27	50	4.5	HN.. 0905..	241,00 €
	AFM45-HN0905-D125-B40-Z10	125	10	40	63	4.5	FOR WDA-KNMTL	306,00 €
	AFM45-HN0905-D160-C40-Z12	160	12	40	63	4.5	INSERT.	377,00 €
	AFM45L-HN0905-D160-C40-Z12	160	12	40	63	4.5		377,00 €
	AFM45L-HN0905-D200-C60-Z16	200	16	60	63	4.5		643,00 €

FACE MILLING TOOLS / PLAN UND ECKMESSERKÖPFE

	CODE / TYP	TOOL DIMENSIONS (mm) <small>MAß</small>					CUTTING INSERT WENDE PLATTE	PRICE / PREIS
		D	z	d	L	a		
 <p>NEW</p> <p>45°</p>	AFM45-NN2007-D100-A32-Z07-H	100	7	32	50	6	NNMU 2007..	219,00 €
	AFM45-NN2007-D125-B40-Z08	125	8	40	63	6	FOR MTSBSH	260,00 €
	AFM45-NN2007-D160-C40-Z10	160	10	40	63	6	INSERT.	347,00 €
 <p>45°</p>	AFM45-SE12-D050-A22-Z04-H	50	4	22	40	6		122,00 €
	AFM45L-SE12-D050-A22-Z04-H	50	4	22	40	6	SE.. 12T3..	122,00 €
	AFM45-SE12-D063-A22-Z05-H	63	5	22	40	6	FOR ZCC	143,00 €
	AFM45L-SE12-D063-A22-Z05-H	63	5	22	40	6	INSERT.	143,00 €
	AFM45-SE12-D080-A27-Z06-H	80	6	27	50	6		163,00 €
	AFM45L-SE12-D080-A27-Z06-H	80	6	27	50	6	R245-12T3..	163,00 €
	AFM45-SE12-D100-A32-Z07-H	100	7	32	50	6	FOR SNDVK	205,00 €
	AFM45-SE12-D125-B40-Z08	125	8	40	63	6	INSERT.	270,00 €
	AFM45-SE12-D160-C40-Z10	160	10	40	63	6		337,00 €
	AFM45L-SE12-D160-C40-Z10	160	10	40	63	6		337,00 €
	AFM45-SE12-D200-C60-Z12	200	12	60	63	6		408,00 €
	AFM45-SE14M4-D063-A22-Z04-H	63	4	22	40	7		153,00 €
	AFM45-SE14M4-D080-A27-Z05-H	80	5	27	50	7	SE.. 14M4..	179,00 €
	AFM45-SE14M4-D100-A32-Z05-H	100	5	32	50	7	FOR KRLY	219,00 €
	AFM45-SE14M4-D125-B40-Z06	125	6	40	63	7	INSERT.	291,00 €
AFM45-SE14M4-D160-C40-Z07	160	7	40	63	7		357,00 €	
 <p>45°</p>	AFM45-SE13-D050-A22-Z04-H	50	4	22	40	6		149,00 €
	AFM45-SE13-D063-A22-Z05-H	63	5	22	40	6		175,00 €
	AFM45-SE13-D080-A27-Z06-H	80	6	27	50	6	SEMT 13T3..	197,00 €
	AFM45S-SE13-D050-A22-Z05-H	50	5	22	40	6	FOR SMTM-DJT	237,00 €
	AFM45S-SE13-D063-A22-Z06-H	63	6	22	40	6	INSERT.	277,00 €
	AFM45S-SE13-D080-A27-Z08-H	80	8	27	50	6		346,00 €
	AFM45S-SE13-D100-A32-Z10-H	100	10	32	50	6		439,00 €
	AFM45S-SE13-D125-B40-Z12	125	12	40	63	6		561,00 €
 <p>45°</p>	AFM45-SA1706-D080-A27-Z06-H	80	6	27	50	8.4	SAKU 1706..	194,00 €
	AFM45-SA1706-D100-A32-Z07-H	100	7	32	50	8.4	FOR CRTZT	219,00 €
	AFM45-SA1706-D125-B40-Z09	125	9	40	63	8.4	INSERT.	306,00 €

FACE MILLING TOOLS / PLAN UND ECKMESSERKÖPFE

	CODE / TYP	TOOL DIMENSIONS (mm) <small>MAB</small>					CUTTING INSERT WENDE PLATTE	PRICE / PREIS
		D	z	d	L	a		
	AFM45C-SN12..-D050-A22-Z04-H	50	4	22	42	6		148,00 €
	AFM45CL-SN12..-D050-A22-Z05-H	50	5	22	42	6		163,00 €
	AFM45C-SN12..-D050-A22-Z05-H	50	5	22	42	6		163,00 €
	AFM45C-SN12..-D063-A22-Z06-H	63	6	22	42	6		170,00 €
	AFM45C-SN12..-D063-A22-Z07-H	63	7	22	42	6		186,00 €
	AFM45CL-SN12..-D063-A22-Z07-H	63	7	22	42	6		186,00 €
	AFM45C-SN12..-D080-A27-Z07-H	80	7	27	52	6	SN.. 12...	198,00 €
	AFM45C-SN12..-D080-A27-Z08-H	80	8	27	52	6	FOR	213,00 €
	AFM45CL-SN12..-D080-A27-Z08-H	80	8	27	52	6	WLTR-LMN-ACHTK	213,00 €
	AFM45C-SN12..-D100-A32-Z08-H	100	8	32	52	6	INSERT.	224,00 €
	AFM45C-SN12..-D100-A32-Z10-H	100	10	32	52	6		242,00 €
	AFM45CL-SN12..-D100-A32-Z10-H	100	10	32	52	6		242,00 €
	AFM45C-SN12..-D125-B40-Z11	125	11	40	65	6		337,00 €
	AFM45CL-SN12..-D125-B40-Z11	125	11	40	65	6		337,00 €
	AFM45C-SN12..-D160-C40-Z12	160	12	40	65	6		415,00 €
	AFM45C-SN12..-D200-C60-Z14	200	14	60	65	6		707,00 €
AFM45CL-SN12..-D200-C60-Z14	200	14	60	65	6		707,00 €	
45°								
	AFM45C-SN1206-D050-A22-Z04-H	50	4	22	42	6		133,00 €
	AFM45CL-SN1206-D050-A22-Z05-H	50	5	22	22	6		148,00 €
	AFM45C-SN1206-D050-A22-Z05-H	50	5	22	42	6		148,00 €
	AFM45C-SN1206-D063-A22-Z06-H	63	6	22	42	6		153,00 €
	AFM45C-SN1206-D063-A22-Z07-H	63	7	22	42	6	SN.. 1206..	168,00 €
	AFM45CL-SN1206-D063-A22-Z07-H	63	7	22	42	6	FOR	168,00 €
	AFM45C-SN1206-D080-A27-Z07-H	80	7	27	52	6	KRLY-PLBT-BHLR	179,00 €
	AFM45C-SN1206-D080-A27-Z08-H	80	8	27	52	6	INSERT.	194,00 €
	AFM45CL-SN1206-D080-A27-Z08-H	80	8	27	52	6		194,00 €
	AFM45C-SN1206-D100-A32-Z08-H	100	8	32	52	6		204,00 €
	AFM45C-SN1206-D100-A32-Z10-H	100	10	32	52	6		219,00 €
	AFM45CL-SN1206-D100-A32-Z10-H	100	10	32	52	6		219,00 €
	AFM45C-SN1206-D125-B40-Z11	125	11	40	65	6		306,00 €
	AFM45CL-SN1206-D125-B40-Z11	125	11	40	65	6		306,00 €
	AFM45C-SN1206-D160-C40-Z12	160	12	40	65	6		377,00 €
	AFM45C-SN1206-D200-C60-Z14	200	14	60	65	6		643,00 €
AFM45CL-SN1206-D200-C60-Z14	200	14	60	65	6		643,00 €	
45°								
	AFM45C-SN12Z-D050-A22-Z05-H	50	5	22	42	6	SNEG 1205..	148,00 €
	AFM45C-SN12Z-D063-A22-Z06-H	63	6	22	42	6	FOR ZCC	168,00 €
	AFM45C-SN12Z-D080-A27-Z07-H	80	7	27	52	6	INSERT.	194,00 €
	AFM45C-SN12Z-D100-A32-Z09-H	100	9	32	52	6		219,00 €
	AFM45C-SN12Z-D125-B40-Z11	125	11	40	65	6		306,00 €
	AFM45C-SN12Z-D160-C40-Z12	160	12	60	65	6		377,00 €
	AFM45C-SN12Z-D200-C60-Z14	200	14	60	65	6		643,00 €
45°								

FACE MILLING TOOLS / PLAN UND ECKMESSERKÖPFE

	CODE / TYP	TOOL DIMENSIONS (mm) <small>MAß</small>					CUTTING INSERT WENDE PLATTE	PRICE / PREIS
		D	z	d	L	a		
 <p>45°</p>	AFM45-ON0806-D063-A22-Z05-H	63	5	22	40	4	ON.. 0806.. ISO	168,00 €
	AFM45-ON0806-D080-A27-Z06-H	80	6	27	50	4		194,00 €
	AFM45-ON0806-D100-A32-Z07-H	100	7	32	50	4		219,00 €
	AFM45-ON0806-D125-B40-Z08	125	8	40	63	4		260,00 €
	AFM45-ON0806-D160-C40-Z10	160	10	40	63	4		347,00 €
	AFM45-ON0806-D200-C60-Z12	200	12	60	63	4		561,00 €
	AFM45-ON0806-D315-D60-Z16	315	16	60	63	4		995,00 €
 <p>45°</p>	AFM45-XN0906-D063-A22-Z06-H	63	6	22	50	5	XNMU 0906..	210,00 €
	AFM45-XN0906-D080-A27-Z06-H	80	6	27	50	5	FOR TGTC	223,00 €
	AFM45-XN0906-D100-A32-Z07-H	100	7	32	55	5	INSERT.	253,00 €
	AFM45-XN0906-D125-B40-Z08	125	8	40	63	5		299,00 €
 <p>66°</p>	AFM66-PN0905-D050-A22-Z05	50	5	22	40	8	PNMU 0905..	161,00 €
	AFM66-PN0905-D063-A22-Z06	63	6	22	40	8	FOR KYCR	188,00 €
	AFM66-PN0905-D080-A27-Z08	80	8	27	50	8	INSERT.	214,00 €
	AFM66-PN0905-D100-A32-Z10	100	10	32	50	8		268,00 €
	AFM66-PN0905-D125-B40-Z12	125	12	40	63	8		354,00 €
 <p>67°</p>	AFM67-PN1105-D050-A22-Z05	50	5	22	50	5	PNEG 1105.. FOR ZCC INSERT.	161,00 €
	AFM67-PN1105-D063-A22-Z06	63	6	22	50	5		188,00 €
	AFM67-PN1105-D080-A27-Z08	80	8	27	50	5		214,00 €
	AFM67-PN1105-D100-B32-Z10	100	10	32	50	5		268,00 €
	AFM67-PN1105-D125-B40-Z12	125	12	40	63	5		354,00 €
	AFM67-PN1105-D160-C40-Z14	160	14	40	63	5		536,00 €
 <p>75°</p>	AFM75-AP16-D063-A22-Z04-H	63	4	22	40	6	AP. 1604.. ISO	134,00 €
	AFM75-AP16-D080-A27-Z05-H	80	5	27	50	6		154,00 €
	AFM75-AP16-D100-A32-Z06-H	100	6	32	50	6		185,00 €
	AFM75-AP16-D125-B40-Z07	125	7	40	63	6		245,00 €

FACE MILLING TOOLS / PLAN UND ECKMESSERKÖPFE

	CODE / TYP	TOOL DIMENSIONS (mm) <small>MAß</small>					CUTTING INSERT <small>WENDE PLATTE</small>	PRICE / PREIS
		D	z	d	L	a		
 75°	AFM75-X012-D050-A22-Z04-H	50	4	22	40	-		133,00 €
	AFM75-X012-D063-A22-Z05-H	63	5	22	40	-	XOMX 1204..	148,00 €
	AFM75-X012-D080-A27-Z06-H	80	6	27	50	-	ISO	184,00 €
 88°	AFM88-SN1305-D050-A22-Z04	50	4	22	40	5		136,00 €
	AFM88-SN1305-D050-A22-Z05	50	5	22	40	5	SNMU 1305..	153,00 €
	AFM88-SN1305-D063-A22-Z05	63	5	22	40	5	FOR KYCR	158,00 €
	AFM88-SN1305-D063-A22-Z07	63	7	22	40	5	INSERT.	185,00 €
	AFM88-SN1305-D080-A27-Z06	80	6	27	50	5		185,00 €
	AFM88-SN1305-D080-A27-Z09	80	9	27	50	5		225,00 €
	AFM88-SN1305-D100-A32-Z07	100	7	32	50	5		206,00 €
	AFM88-SN1305-D100-A32-Z11	100	11	32	50	5		259,00 €
AFM88-SN1305-D125-B40-Z13	125	13	40	63	5		334,00 €	
 88°	AFM88-SN1306-D050-A22-Z05-H	50	5	22	40	5	SNGX 1306..	162,00 €
	AFM88-SN1306-D063-A22-Z06-H	63	6	22	40	5	FOR TGTC	185,00 €
	AFM88-SN1306-D080-A27-Z07-H	80	7	27	50	5	INSERT.	214,00 €
 88°	AFM88C-SN1206-D063-A22-Z06-H	63	6	22	40	11.5	SN.. 1206..	168,00 €
	AFM88C-SN1206-D080-A27-Z07-H	80	7	27	50	11.5	ISO	195,00 €
	AFM88C-SN1206-D100-A32-Z09-H	100	9	32	52	11.5		219,00 €
 88°	AFM88C-SN12..-D063-A22-Z06-H	63	6	22	40	11.5	SN.. 12....	186,00 €
	AFM88C-SN12..-D080-A27-Z07-H	80	7	27	50	11.5	ISO	214,00 €
	AFM88C-SN12..-D100-A32-Z09-H	100	9	32	52	11.5		242,00 €

FACE MILLING TOOLS / PLAN UND ECKMESSERKÖPFE



	CODE / TYP	TOOL DIMENSIONS (mm) <small>MAß</small>					CUTTING INSERT <small>WENDE PLATTE</small>	PRICE / PREIS
		D	z	d	L	a		
	AFM88C-SN12Z-D063-A22-Z06-H	63	6	22	40	11.5	SNEG 1205..	168,00 €
	AFM88C-SN12Z-D080-A27-Z07-H	80	7	27	50	11.5	FOR ZCC INSERT.	195,00 €
88°								
	AFM90-AD10T3-D040-A16-Z06-H	40	6	16	40	10	ADMT 10T3..	128,00 €
	AFM90-AD10T3-D050-A22-Z07-H	50	7	22	40	10	FOR WLTR INSERT.	151,00 €
90°								
	AFM90-AD1505-D040-A16-Z04-H	40	4	16	40	15	AD.. 1505..	107,00 €
	AFM90-AD1505-D050-A22-Z05-H	50	5	22	40	15		128,00 €
	AFM90-AD1505-D063-A22-Z06-H	63	6	22	40	15	FOR ISCR	148,00 €
	AFM90-AD1505-D080-A27-Z07-H	80	7	27	50	15	INSERT.	168,00 €
	AFM90-AD1505-D100-A32-Z08-H	100	8	32	50	15		205,00 €
	AFM90-AD1505-D125-B40-Z09	125	9	40	63	15		270,00 €
90°								
	AFM90-AD1505D-D050-A22-Z05-H	50	5	22	40	14.3	ADKT 150508	128,00 €
	AFM90-AD1505D-D063-A27-Z06-H	63	6	27	50	14.3	FOR DJT	148,00 €
	AFM90-AD1505D-D080-A27-Z08-H	80	8	27	50	14.3	INSERT.	179,00 €
	<small>NEW</small> AFM90-AD1505D-D100-A32-Z08-H	100	8	32	50	14.3		205,00 €
	<small>NEW</small> AFM90-AD1505D-D125-B40-Z09	125	9	40	63	14.3		270,00 €
90°								
	AFM90-AN11-D040-A16-Z04-H	40	4	16	40	11	ANGX 1105..	125,00 €
	AFM90-AN1506-D050-A22-Z04-H	50	4	22	40	14.5		130,00 €
	AFM90-AN1506-D063-A22-Z05-H	63	5	22	40	14.5	ANGX 1506..	151,00 €
	AFM90-AN1506-D080-A27-Z06-H	80	6	27	50	14.5	FOR ZCC	172,00 €
	AFM90-AN1506-D100-A32-Z08-H	100	8	32	50	14.5	INSERT.	207,00 €
	AFM90-AN1506-D125-B40-Z09	125	9	40	63	14.5		311,00 €
	AFM90-AN1506-D160-C40-Z10	160	10	40	63	14.5		403,00 €
90°								

FACE MILLING TOOLS / PLAN UND ECKMESSERKÖPFE

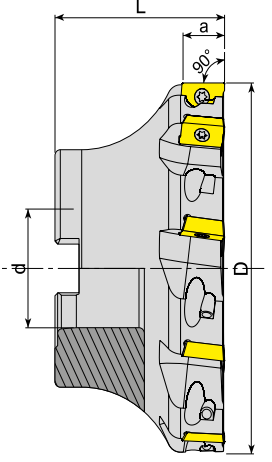

	CODE / TYP	TOOL DIMENSIONS (mm) <small>MAß</small>					CUTTING INSERT <small>WENDE PLATTE</small>	PRICE / PREIS
		D	z	d	L	a		
 90°	AFM90-AN1607-D050-A22-Z04-H	50	4	22	40	15	AN.X 1607..	166,00 €
	AFM90-AN1607-D063-A22-Z06-H	63	6	22	40	15	FOR TGTC	225,00 €
	AFM90-AN1607-D080-A27-Z07-H	80	7	27	50	15	INSERT.	252,00 €
	AFM90-AN1607-D100-A32-Z08-H	100	8	32	50	15		278,00 €
	NEW AFM90-AN1607-D125-B40-Z10	125	10	40	63	15		371,00 €
 90°	AFM90-AN12-D040-A16-Z04-H	40	4	16	40	12	ANKX 1205..	122,00 €
	AFM90-AN12-D050-A22-Z05-H	50	5	22	40	12	FOR ISCR	145,00 €
	AFM90-AN12-D063-A27-Z06-H	63	6	27	50	12	INSERT.	167,00 €
 90°	AFM90-AN1207-D040-A16-Z04-H	40	4	16	40	10	ANKX 1207..	122,00 €
	AFM90-AN1207-D050-A22-Z05-H	50	5	22	40	10	FOR XTC-GSC	145,00 €
	AFM90-AN1207-D063-A22-Z06-H	63	6	22	40	10	INSERT.	167,00 €
	AFM90-AN1607X-D050-A22-Z04-H	50	4	22	40	15	ANKX 1607..	136,00 €
	AFM90-AN1607X-D063-A22-Z06-H	63	6	22	40	15	FOR XTC-GSC	184,00 €
	AFM90-AN1607X-D080-A27-Z07-H	80	7	27	50	15	INSERT.	205,00 €
 90°	AFM90-A01236-D050-A22-Z05-H	50	5	22	40	12	AO.. 1236..	153,00 €
	AFM90-A01848-D050-A22-Z05-H	50	5	22	40	15	AO.. 1848..	153,00 €
	AFM90-A01848-D063-A22-Z06-H	63	6	22	40	15	FOR MTSBH INSERT.	170,00 €
 90°	AFM90-AP1705-D050-A22-Z05-H	50	5	22	40	16	AP.. 1705..	128,00 €
	AFM90-AP1705-D063-A22-Z06-H	63	6	22	40	16	FOR TGTC-LMNA	148,00 €
	AFM90-AP1705-D080-A27-Z07-H	80	7	27	50	16	INSERT.	168,00 €
	AFM90-AP1705-D100-A32-Z08-H	100	8	32	50	16		205,00 €

FACE MILLING TOOLS / PLAN UND ECKMESSERKÖPFE

100/101

	CODE / TYP	TOOL DIMENSIONS (mm) <small>MAß</small>					CUTTING INSERT <small>WENDE PLATTE</small>	PRICE / PREIS
		D	z	d	L	a		
  90°	AFM90-AP10-D040-A16-Z05-H	40	5	16	40	10		98,00 €
	AFM90-AP10-D050-A22-Z06-H	50	6	22	40	10		118,00 €
	AFM90-AP10-D063-A22-Z07-H	63	7	22	40	10	AP.. 1003..	133,00 €
	AFM90-AP10-D080-A27-Z08-H	80	8	27	50	10	ISO	153,00 €
	AFM90-AP10-D100-A32-Z09-H	100	9	32	50	10		184,00 €
	AFM90-AP16-D040-A16-Z04-H	40	4	16	40	16		98,00 €
	AFM90-AP16-D050-A22-Z05-H	50	5	22	40	16		118,00 €
	AFM90-AP16-D052-A22-Z05-H	52	5	22	40	16		122,00 €
	AFM90-AP16-D063-A22-Z06-H	63	6	22	40	16	AP.. 1604..	133,00 €
	AFM90-AP16-D080-A27-Z07-H	80	7	27	50	16	ISO	153,00 €
	AFM90-AP16-D100-A32-Z08-H	100	8	32	50	16		184,00 €
	AFM90-AP16-D125-B40-Z09	125	9	40	63	16		245,00 €
	AFM90-AP16-D160-C40-Z10	160	10	40	63	16		306,00 €
	AFM90-AP16-D200-C60-Z12	200	12	60	63	16		510,00 €
	AFM90-AP16DJ-D050-A22-Z05-H	50	5	22	40	16	AP.. 1604..	118,00 €
	AFM90-AP16DJ-D063-A22-Z06-H	63	6	22	40	16	FOR DJT	133,00 €
	AFM90-AP16DJ-D080-A27-Z07-H	80	7	27	50	16	INSERT.	153,00 €
	AFM90-AP16L-D050-A22-Z05-H	50	5	22	40	16	AP.. 1604..	118,00 €
	AFM90-AP16L-D063-A22-Z06-H	63	6	22	40	16	FOR LMNA	133,00 €
	AFM90-AP16L-D080-A27-Z07-H	80	7	27	50	16	INSERT.	153,00 €
	AFM90-AP16P-D040-A16-Z04-H	40	4	16	40	16		98,00 €
	AFM90-AP16P-D050-A22-Z05-H	50	5	22	40	16	AP.. 1604..	118,00 €
	AFM90-AP16P-D063-A22-Z06-H	63	6	22	40	16	FOR PLBT	133,00 €
	AFM90-AP16P-D080-A27-Z07-H	80	7	27	50	16	INSERT.	153,00 €
	AFM90-AP16P-D100-A32-Z08-H	100	8	32	50	16		184,00 €
	<small>NEW</small> AFM90-AP16A-D050-A22-Z05-H	50	5	22	40	15		118,00 €
	<small>NEW</small> AFM90-AP16A-D063-A22-Z06-H	63	6	22	40	15	AP.. 1604..	133,00 €
	<small>NEW</small> AFM90-AP16A-D080-A27-Z07-H	80	7	27	50	15	FOR ACHTK	153,00 €
<small>NEW</small> AFM90-AP16A-D100-A32-Z08-H	100	8	32	50	15	INSERT.	184,00 €	
<small>NEW</small> AFM90-AP16A-D125-B40-Z09	125	9	40	63	15		245,00 €	
 90°	AFM90-AX1235-D040-A16-Z06-H	40	6	16	40	10	AX.T 1235..	128,00 €
	AFM90-AX1235-D050-A22-Z07-H	50	7	22	40	10	FOR SMTM	148,00 €
	AFM90-AX1235-D063-A22-Z08-H	63	8	22	40	10	INSERT.	168,00 €
	AFM90-AX1235-D080-A27-Z10-H	80	10	27	50	10		213,00 €
	AFM90-AX1705-D040-A16-Z04-H	40	4	16	40	14		112,00 €
	AFM90-AX1705-D050-A22-Z05-H	50	5	22	40	14	AX.T 1705..	135,00 €
	AFM90-AX1705-D063-A22-Z06-H	63	6	22	40	14	FOR SMTM	154,00 €
	AFM90-AX1705-D080-A27-Z07-H	80	7	27	50	14	INSERT.	176,00 €
AFM90-AX1705-D100-A32-Z08-H	100	8	32	50	14		211,00 €	
 90°	AFM90-BD1704-D050-A22-Z05-H	50	5	22	40	15.7	BDMT 1704..	132,00 €
	AFM90-BD1704-D063-A22-Z06-H	63	6	22	40	15.7	FOR KYCR	145,00 €
	AFM90-BD1704-D080-A27-Z07-H	80	7	27	50	15.7	INSERT.	167,00 €

FACE MILLING TOOLS / PLAN UND ECKMESSERKÖPFE

	CODE / TYP	TOOL DIMENSIONS (mm) <small>MAß</small>					CUTTING INSERT <small>WENDE PLATTE</small>	PRICE / PREIS
		D	z	d	L	a		
 NEW 90°	AFM90-LN1506X-D063-A22-Z06	63	6	22	40	7	LNMT 1506..	168,00 €
	AFM90-LN1506X-D080-A27-Z07	80	7	27	50	7	FOR XTC-GSC	213,00 €
	AFM90-LN1506X-D100-A32-Z08	100	8	32	50	7	INSERT.	261,00 €
 NEW 90°	AFM90-LN1306W-D050-A22-Z05-H	50	5	22	40	12	LNHU 1306..	145,00 €
	AFM90-LN1306W-D063-A22-Z06-H	63	6	22	40	12	FOR WLTR	168,00 €
	AFM90-LN1306W-D080-A27-Z07-H	80	7	27	50	12	INSERT.	213,00 €
 90°	AFM90-LN1106-D050-A22-Z05	50	5	22	40	10		145,00 €
	AFM90-LN1106-D063-A22-Z06	63	6	22	40	10		168,00 €
	AFM90-LN1106-D080-A27-Z08	80	8	27	50	10	LNMT 1106..	213,00 €
	AFM90L-LN1106-D080-A27-Z08	80	8	27	50	10	FOR ISCR	213,00 €
	AFM90-LN1106-D100-A32-Z09	100	9	32	50	10	INSERT.	261,00 €
	AFM90L-LN1106-D100-A32-Z09	100	9	32	50	10		261,00 €
	AFM90-LN1106-D125-B40-Z10	125	10	40	63	10		339,00 €
	AFM90-LN1306-D040-A16-Z04-H	40	4	16	40	12.5	T490	122,00 €
	AFM90-LN1306-D050-A22-Z05-H	50	5	22	40	12.5	LNMT 1306..	145,00 €
	AFM90-LN1306-D063-A22-Z06-H	63	6	22	40	12.5	FOR ISCR	168,00 €
	AFM90-LN1306-D080-A27-Z07-H	80	7	27	50	12.5	INSERT.	213,00 €
	AFM90-LN1306-D100-A32-Z08-H	100	8	32	50	12.5		261,00 €
	AFM90L-LN1506-D040-A16-Z04	40	4	16	40	14		122,00 €
	AFM90-LN1506-D040-A16-Z04	40	4	16	40	14	LNMT 1506..	122,00 €
	AFM90-LN1506-D050-A22-Z05	50	5	22	40	14	FOR ISCR	145,00 €
	AFM90-LN1506-D063-A22-Z06	63	6	22	40	14	INSERT.	168,00 €
	AFM90-LN1506-D080-A27-Z07	80	7	27	50	14		213,00 €
	AFM90-LN1607-D050-A22-Z03-H	50	3	22	40	16		145,00 €
	AFM90-LN1607-D063-A22-Z04-H	63	4	22	40	16	LNHT 1607..	168,00 €
	AFM90-LN1607-D080-A27-Z05-H	80	5	27	50	16	FOR ISCR	213,00 €
AFM90-LN1607-D100-A32-Z06-H	100	6	32	50	16	INSERT.	261,00 €	

FACE MILLING TOOLS / PLAN UND ECKMESSERKÖPFE

	CODE / TYP	TOOL DIMENSIONS (mm) <i>MAß</i>					CUTTING INSERT WENDE PLATTE	PRICE / PREIS
		D	z	d	L	a		
 <p>90°</p>	AFM90-LN1307-D050-A22-Z04-H	50	4	22	40	13	LNGX 1307..	186,00 €
	AFM90-LN1307-D063-A22-Z06-H	63	6	22	40	13	FOR WLTR	223,00 €
	AFM90-LN1307-D080-A27-Z07-H	80	7	27	50	13	INSERT.	244,00 €
	AFM90-LN1307-D100-A32-Z08-H	100	8	32	50	13		264,00 €
 <p>90°</p>	AFM90-LN15Z-D050-A22-Z04	50	4	22	40	15	LNKT 1506..	145,00 €
	AFM90-LN15Z-D063-A22-Z05	63	5	22	40	15	FOR ZCC	168,00 €
	AFM90-LN15Z-D080-A27-Z06	80	6	27	50	15	INSERT.	193,00 €
	AFM90-LN15Z-D100-A32-Z07	100	7	32	50	15		241,00 €
	AFM90-LN15Z-D125-B40-Z08	125	8	40	63	15		318,00 €
 <p>90°</p>	AFM90-LN15T6-D050-A22-Z05-H	50	5	22	40	15.5	LNGU 15T6..	145,00 €
	AFM90-LN15T6-D063-A22-Z06-H	63	6	22	40	15.5	FOR KNMTL	167,00 €
	AFM90-LN15T6-D080-A27-Z07-H	80	7	27	50	15.5	INSERT.	190,00 €
 <p>90°</p>	AFM90-R290.12-D050-A22-Z04-H	50	4	22	40	10.7		122,00 €
	AFM90-R290.12-D063-A22-Z05-H	63	5	22	40	10.7	R290-12T3..	143,00 €
	AFM90-R290.12-D080-A27-Z07-H	80	7	27	50	10.7	FOR SNDVK	163,00 €
	AFM90-R290.12-D100-A32-Z09-H	100	9	32	50	10.7	INSERT.	205,00 €
	AFM90-R290.12-D125-B40-Z11	125	11	40	63	10.7		270,00 €

Cutting Calculation : P 114 / Schnittdatenberechnung : S 114

Ordering Example/Beispiel Bestellformular: 1pcs. AFM90-LN1307-D050-A22-Z04-H



FACE MILLING TOOLS / PLAN UND ECKMESSERKÖPFE

	CODE / TYP	TOOL DIMENSIONS (mm) MAß					CUTTING INSERT WENDE PLATTE	PRICE / PREIS
		D	z	d	L	a		
  90°	AFM90-R390.11-D040-A16-Z05-H	40	5	16	40	10	R390-11T3..	107,00 €
	AFM90-R390.11-D050-A22-Z06-H	50	6	22	40	10	FOR SNDVK	128,00 €
	AFM90-R390.11-D063-A22-Z07-H	63	7	22	40	10	INSERT.	148,00 €
	AFM90-R390.11-D080-A27-Z09-H	80	9	27	50	10		193,00 €
	AFM90-R390.17-D040-A16-Z04-H	40	4	16	40	15.4		107,00 €
	AFM90-R390.17-D050-A22-Z05-H	50	5	22	40	15.4	R390-1704..	128,00 €
	AFM90-R390.17-D063-A22-Z06-H	63	6	22	40	15.4	FOR SNDVK	148,00 €
	AFM90-R390.17-D080-A27-Z07-H	80	7	27	50	15.4	INSERT.	168,00 €
	AFM90-R390.17-D100-A32-Z08-H	100	8	32	50	15.4		205,00 €
	AFM90-R390.17-D125-B40-Z09	125	9	40	63	15.4		270,00 €
 90°	AFM90-R390.18-D050-A22-Z04-H	50	4	22	40	15.4		128,00 €
	AFM90-R390.18-D063-A22-Z05-H	63	5	22	40	15.4	R390-1806..	148,00 €
	AFM90-R390.18-D080-A27-Z06-H	80	6	27	50	15.4	FOR SNDVK	168,00 €
	AFM90-R390.18-D100-A32-Z07-H	100	7	32	50	15.4	INSERT.	205,00 €
	AFM90-R390.18-D125-B40-Z08	125	8	40	63	15.4		270,00 €
 90°	AFM90-490R14-D050-A22-Z04-H	50	4	22	40	10	490R-1404..	168,00 €
	AFM90-490R14-D063-A22-Z05-H	63	5	22	40	10	FOR SNDVK	197,00 €
	AFM90-490R14-D080-A27-Z07-H	80	7	27	50	10	INSERT.	224,00 €
 90°	AFM90-RT10-D040-A16-Z06-H	40	6	16	40	10	RT 1003..	107,00 €
	AFM90-RT10-D050-A22-Z07-H	50	7	22	40	10	FOR SFTY	126,00 €
	AFM90-RT10-D063-A22-Z09-H	63	9	22	50	10	INSERT.	154,00 €
 90°	AFM90-SD09M4-D040-A16-Z04-H	40	4	16	40	9	SD.. 09M4..	123,00 €
	AFM90-SD09M4-D050-A22-Z05-H	50	5	22	40	9	FOR KRLY	133,00 €
	AFM90-SD09M4-D063-A22-Z06-H	63	6	22	40	9	INSERT.	153,00 €
	AFM90-SD1305-D050-A22-Z04-H	50	4	22	40	13	SD.. 1305..	133,00 €
	AFM90-SD1305-D063-A22-Z05-H	63	5	22	40	13	FOR KRLY	153,00 €
	AFM90-SD1305-D080-A27-Z06-H	80	6	27	50	13	INSERT.	179,00 €
	AFM90-SD1305-D100-A32-Z07-H	100	7	32	50	13		219,00 €
	AFM90-SD1305-D125-B40-Z08	125	8	40	63	13		291,00 €
AFM90-SD1305-D160-C40-Z10	160	10	40	63	13		357,00 €	
 90°	AFM90S-SD1204-D050-A22-Z04-H	50	4	22	40	11	SDMT 1204..	189,00 €
	AFM90S-SD1204-D063-A22-Z05-H	63	5	22	40	11	FOR DJT	224,00 €
	AFM90S-SD1204-D080-A27-Z06-H	80	6	27	50	11	INSERT.	250,00 €
	AFM90S-SD1204-D100-A32-Z08-H	100	8	32	50	11		321,00 €
	AFM90S-SD1204-D125-B40-Z10	125	10	40	63	11		418,00 €
	AFM90S-SD1204-D160-C40-Z12	160	12	40	63	11		520,00 €

FACE MILLING TOOLS / PLAN UND ECKMESSERKÖPFE

	CODE / TYP	TOOL DIMENSIONS (mm) <i>MAß</i>					CUTTING INSERT WENDE PLATTE	PRICE / PREIS
		D	z	d	L	a		
 <p>90°</p>	AFM90-SE09-D040-A16-Z04-H	40	4	16	40	6.7	SEET 09T3..	118,00 €
	AFM90-SE09-D050-A22-Z05-H	50	5	22	40	6.7	FOR ZCC	138,00 €
	AFM90-SE09-D063-A22-Z06-H	63	6	22	40	6.7	INSERT.	158,00 €
 <p>90°</p>	AFM90-SE12-D050 A22 Z04-H	50	4	22	40	12	SEET 1203..	122,00 €
	AFM90-SE12-D063 A22 Z05-H	63	5	22	40	12		FOR ZCC
	AFM90-SE12-D080 A27 Z07-H	80	7	27	50	12	INSERT.	163,00 €
	AFM90-SE12-D100 A32 Z09-H	100	9	32	50	12		205,00 €
	AFM90-SE12-D125 B40 Z11	125	11	40	63	12		270,00 €
 <p>90°</p>	AFM90-SP1004-D040-A16-Z04-H	40	4	16	40	9.4	SPMT 1004..	123,00 €
	AFM90-SP1004-D050-A22-Z06-H	50	6	22	40	9.4	XPMT 1004..	153,00 €
							QPMR 1004.. QPMT 1004.. FOR ISCR INSERT.	
 <p>90°</p>	AFM90-TN2207-D063-A22-Z04-H	63	4	22	40	15	TN.X 2207..	171,00 €
	AFM90-TN2207-D080-A27-Z05-H	80	5	27	50	15	FOR TGTC	209,00 €
	AFM90-TN2207-D100-B32-Z06	100	6	32	50	15	INSERT.	252,00 €
	AFM90-TN2207-D125-B40-Z08	125	8	40	63	15		333,00 €
 <p>90°</p>	AFM90-TP2205-D063-A22-Z04	63	4	22	40	18	TPKT 2205..	161,00 €
	AFM90-TP2205-D080-A27-Z06	80	6	27	50	18		FOR TGTC
	AFM90-TP2205-D100-A32-Z07	100	7	32	50	18	INSERT.	231,00 €
	AFM90-TP2205-D125-B40-Z08	125	8	40	63	18		311,00 €
	AFM90-TP2205-D160-C40-Z09	160	9	40	63	18		418,00 €
	AFM90-TP2205-D200-C60-Z12	200	12	60	63	18		583,00 €
 <p>90°</p>	AFM90-WN0604Z-D040-A16-Z04-H	40	4	16	40	5.7	WNHU 0604..	158,00 €
	AFM90-WN0604Z-D050-A22-Z05-H	50	5	22	40	5.7	FOR ZCC	165,00 €
	AFM90-WN0604Z-D063-A22-Z06-H	63	6	22	40	5.7	INSERT.	178,00 €
	AFM90-WN0604Z-D080-A27-Z07-H	80	7	27	50	5.7		191,00 €
	AFM90-WN0604Z-D100-A32-Z09-H	100	9	32	50	5.7		242,00 €
	AFM90-WN0806Z-D050-A22-Z04-H	50	4	22	40	7.7	WNHU 0806..	165,00 €
	AFM90-WN0806Z-D063-A22-Z05-H	63	5	22	40	7.7		FOR ZCC
	AFM90-WN0806Z-D080-A27-Z06-H	80	6	27	50	7.7	INSERT.	171,00 €
	AFM90-WN0806Z-D100-A32-Z08-H	100	8	32	50	7.7		217,00 €
	AFM90-WN0806Z-D125-B40-Z10	125	10	40	63	7.7		283,00 €
	AFM90-WN0806Z-D160-C40-Z12	160	12	40	63	7.7		395,00 €

FACE MILLING TOOLS / PLAN UND ECKMESSERKÖPFE

	CODE / TYP	TOOL DIMENSIONS (mm) <small>MAß</small>					CUTTING INSERT <small>WENDE PLATTE</small>	PRICE / PREIS
		D	z	d	L	a		
 90°	AFM90-WN0806-D050-A16-Z04-H	50	4	16	40	8	WNMX 080608	176,00 €
	AFM90-WN0806-D063-A22-Z05-H	63	5	22	40	8	FOR KYCR-JD	212,00 €
	AFM90-WN0806-D080-A27-Z07-H	80	7	27	50	8	INSERT.	255,00 €
 90°	AFM90-XN0806-D050-A22-Z04-H	50	4	22	40	7.5	XNEX 0806..	128,00 €
	AFM90-XN0806-D063-A22-Z05-H	63	5	22	40	7.5	FOR SC	148,00 €
	AFM90-XN0806-D080-A27-Z07-H	80	7	27	50	7.5	INSERT.	189,00 €
	AFM90-XN0806-D100-A32-Z08-H	100	8	32	50	7.5		219,00 €
 90°	AFM90-X012-D040-A16-Z05-H	40	5	16	40	11		98,00 €
	AFM90-X012-D050-A22-Z07-H	50	7	22	40	11	XO.. 1204..	128,00 €
	AFM90-X012-D063-A22-Z08-H	63	8	22	40	11	FOR SC	143,00 €
	AFM90-X012-D080-A27-Z10-H	80	10	27	50	11	INSERT.	173,00 €
	AFM90-X012-D100-A32-Z12-H	100	12	32	50	11		219,00 €
 90°	AFM90-3P1004-D040-A16-Z05-H	40	5	16	40	7	3PKT 1004..	117,00 €
	AFM90-3P1004-D050-A22-Z06-H	50	6	22	40	7	TGTC	141,00 €
	AFM90-3P1505-D050-A22-Z04-H	50	4	22	40	11		117,00 €
	AFM90-3P1505-D050-A22-Z05-H	50	5	22	40	11		138,00 €
	AFM90-3P1505-D063-A22-Z04-H	63	4	22	40	11	3PKT 1505..	133,00 €
	AFM90-3P1505-D063-A22-Z06-H	63	6	22	40	11	FOR TGTC	148,00 €
	<small>NEW</small> AFM90-3P1505-D080-A27-Z07-H	80	7	27	50	11	INSERT.	199,00 €
	<small>NEW</small> AFM90-3P1505-D100-A32-Z08-H	100	8	32	50	11		239,00 €
<small>NEW</small> AFM90-3P1505-D125-B40-Z10	125	10	40	63	11		302,00 €	
 90°	AFM90-4N06-D040-A16-Z05-H	40	5	16	40	6	4NKT 0603..	117,00 €
	AFM90-4N06-D050-A22-Z06-H	50	6	22	40	6	TGTC	141,00 €
							INSERT.	



FACE AND COPY MILLING TOOLS / MESSERKÖPFE FÜR RUNGE WENDESCHNEIDPLATTEN 106/107

	CODE / TYP	TOOL DIMENSIONS (mm) MAß					CUTTING INSERT WENDE PLATTE	PRICE / PREIS
		D	z	d	L	a		
	AFMR-RC10T3-D040-A16-Z04-H	40	4	16	40	5	RC.. 10T3..	112,00 €
	AFMR-RC10T3-D050-A22-Z05-H	50	5	22	50	5	FOR ZCC	134,00 €
	AFMR-RC10T3-D063-A22-Z06-H	63	6	22	50	5	INSERT.	154,00 €
	AFMR-RC1204-D040-A16-Z04-H	40	4	16	40	6	RC.. 1204..	138,00 €
	AFMR-RC1204-D050-A22-Z05-H	50	5	22	50	6	FOR SNDVK	163,00 €
	AFMR-RC1204-D052-A22-Z05-H	52	5	22	50	6	INSERT	152,00 €
	AFMR-RC1204-D063-A22-Z06-H	63	6	22	50	6		175,00 €
	NEW AFMR-RC1204-D063-A27-Z06-H	63	6	27	50	6		175,00 €
AFMR-RC1204-D080-A27-Z07-H	80	7	27	50	6		205,00 €	
	AFMR-RP10T3-D063-A22-Z06-H	63	6	22	40	5	RPNX 10T3..	144,00 €
	AFMR-RP10T3-D080-A27-Z07-H	80	7	27	50	5	CRTZT	167,00 €
	AFMR-RP1204-D040-A16-Z04-H	40	4	16	40	6	RPNX 1204..	105,00 €
	AFMR-RP1204-D080-A27-Z07-H	80	7	27	50	6	FOR CRTZT	167,00 €
						INSERT.		
	AFMR-RP1204M-D050-A22-Z04-H	50	4	22	50	6	RPMT 1204..	122,00 €
	AFMR-RP1204M-D052-A22-Z05-H	52	5	22	50	6	FOR MTSBSH	128,00 €
	AFMR-RP1204M-D063-A22-Z05-H	63	5	22	50	6	INSERT.	132,00 €
	AFMR-RP1204M-D080-A27-Z06-H	80	6	27	50	6		153,00 €
	AFMR-RY10-D040-A16-Z04-H	40	4	16	40	5	RYMX 1004..	105,00 €
	NEW AFMR-RY10-D040-A16-Z05-H	40	5	16	40	5	FOR TGTC	124,00 €
	AFMR-RY10-D050-A22-Z05-H	50	5	22	50	5	INSERT.	133,00 €
	AFMR-RY10-D063-A22-Z06-H	63	6	22	50	5		163,00 €
	AFMR-RY12-D040-A16-Z04-H	40	4	16	40	6		105,00 €
	AFMR-RY12-D050-A22-Z05-H	50	5	22	50	6	RYMX 1205..	133,00 €
	AFMR-RY12-D052-A22-Z05-H	52	5	22	50	6	FOR TGTC	133,00 €
	AFMR-RY12-D063-A22-Z06-H	63	6	22	50	6	INSERT.	163,00 €
NEW AFMR-RY12-D080-A27-Z06-H	80	6	27	50	6		173,00 €	
NEW AFMR-RY12-D100-A32-Z07-H	100	7	32	50	6		218,00 €	
	AFMR-QP10T3-D040-A16-Z04-H	40	4	16	40	5	QP.. 10T3..	130,00 €
	AFMR-QP10T3-D050-A22-Z05-H	50	5	22	40	5	FOR SMTM	154,00 €
	AFMR-QP10T3-D063-A22-Z06-H	63	6	22	40	5	INSERT.	176,00 €
	AFMR-QP1204-D050-A22-Z04-H	50	4	22	40	6	QP.. 1204..	154,00 €
	AFMR-QP1204-D063-A22-Z05-H	63	5	22	40	6	FOR SMTM	176,00 €
						INSERT.		

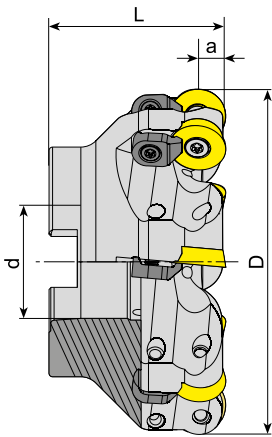

FACE AND COPY MILLING TOOLS / MESSERKÖPFE FÜR RUNGE WENDESCHNEIDPLATTEN

	CODE / TYP	TOOL DIMENSIONS (mm) <i>MAB</i>					CUTTING INSERT WENDE PLATTE	PRICE / PREIS
		D	z	d	L	a		
  -°	AFMR-RD0702-D050-A22-Z06-H	50	6	22	40	3.5	RD.. 0702..	141,00 €
	AFMR-RD0803-D050-A22-Z05-H	50	5	22	40	4	RD.. 0803..	141,00 €
	AFMRC-RD1003-D040-A16-Z04-H	40	4	16	40	5		105,00 €
	AFMRC-RD1003-D050-A22-Z05-H	50	5	22	40	5	RD.. 1003..	124,00 €
	AFMRC-RD1003-D063-A22-Z06-H	63	6	22	40	5	ISO	144,00 €
	AFMRC-RD1003-D080-A27-Z07-H	80	7	27	50	5		167,00 €
	AFMRC-RD1003-D100-A32-Z08-H	100	8	32	50	5		206,00 €
	AFMRC-RD10T3-D050-A22-Z05-H	50	5	22	50	5	RD.. 10T3..	124,00 €
	AFMRC-RD10T3-D063-A22-Z06-H	63	6	22	50	5	ISO	144,00 €
	AFMRC-RD12T3-D040-A16-Z04-H	40	4	16	40	6		105,00 €
	AFMRC-RD12T3-D050-A22-Z05-H	50	5	22	40	6		124,00 €
	AFMRC-RD12T3-D052-A22-Z05-H	52	5	22	40	6	RD.. 12T3..	124,00 €
	AFMRC-RD12T3-D063-A22-Z06-H	63	6	22	40	6	ISO	144,00 €
	AFMRC-RD12T3-D080-A27-Z07-H	80	7	27	50	6		167,00 €
	AFMRC-RD12T3-D100-A32-Z08-H	100	8	32	50	6		206,00 €
	AFMRC-RD12T3-D125-B40-Z09	125	9	40	63	6		273,00 €
	AFMRC-RD1204-D040-A16-Z04-H	40	4	16	40	6		105,00 €
	AFMRC-RD1204-D050-A22-Z05-H	50	5	22	40	6		124,00 €
	AFMRC-RD1204-D052-A22-Z05-H	52	5	22	40	6	RD.. 1204..	124,00 €
	AFMRC-RD1204-D063-A22-Z06-H	63	6	22	40	6	ISO	144,00 €
	AFMRC-RD1204-D080-A27-Z07-H	80	7	27	50	6		167,00 €
	AFMRC-RD1204-D100-A32-Z07-H	100	7	32	50	6		195,00 €
	AFMRC-RD1204-D100-A32-Z08-H	100	8	32	50	6		206,00 €
	AFMRC-RD1604-D050-A22-Z04-H	50	4	22	40	8		134,00 €
	AFMRC-RD1604-D052-A22-Z04-H	52	4	22	50	8		134,00 €
	AFMRC-RD1604-D063-A22-Z05-H	63	5	22	40	8		153,00 €
	AFMRC-RD1604-D066-A22-Z05-H	66	5	22	50	8	RD.. 1604..	153,00 €
	AFMRC-RD1604-D066-A27-Z05-H	66	5	27	50	8	ISO	153,00 €
	AFMRC-RD1604-D080-A27-Z06-H	80	6	27	50	8		192,00 €
	AFMRC-RD1604-D100-A32-Z07-H	100	7	32	50	8		219,00 €
AFMRC-RD1604-D125-B40-Z07	125	7	40	63	8		286,00 €	



FACE MILLING TOOLS / PLAN UND ECKMESSERKÖPFE

	CODE / TYP	TOOL DIMENSIONS (mm) <i>MAB</i>					CUTTING INSERT WENDE PLATTE	PRICE / PREIS
		D	z	d	L	a		
 43°	AFM43C-OF07-D063-A22-Z04	63	4	22	40	5		144,00 €
	AFM43C-OF07-D080-A27-Z05	80	5	27	50	5	OF.. 0704..	167,00 €
	AFM43C-OF07-D100-A32-Z06	100	6	32	50	5	ISO	215,00 €
	AFM43C-OF07-D125-B40-Z08	125	8	40	63	5		306,00 €
	AFM43C-OF07-D160-C40-Z09	160	9	40	63	5		377,00 €
 45°	AFM45C-HN0905-D063-A22-Z07	63	7	22	40	4.5	HN.. 0905..	163,00 €
	AFM45C-HN0905-D080-A27-Z09	80	9	27	50	4.5	FOR WDA-KNMTL	192,00 €
	AFM45C-HN0905-D100-A32-Z11	100	11	32	50	4.5	INSERT.	219,00 €
	AFM45C-HN0905-D125-B40-Z13	125	13	40	63	4.5		268,00 €
	AFM45CL-HN0905-D125-B40-Z10	125	10	40	63	4.5		268,00 €
	AFM45C-HN0905-D160-C40-Z15	160	15	40	63	4.5		383,00 €

FACE MILLING TOOLS / PLAN UND ECKMESSERKÖPFE

	CODE / TYP	TOOL DIMENSIONS (mm) <small>MAß</small>					CUTTING INSERT <small>WENDE PLATTE</small>	PRICE / PREIS
		D	z	d	L	a		
 <p>45°</p>	AFM45C-XN0806-D063-A22-Z05	63	5	22	50	4.5		143,00 €
	AFM45C-XN0806-D080-A27-Z06	80	6	27	50	4.5	XNMU 0806..	158,00 €
	AFM45C-XN0806-D100-A32-Z08	100	8	32	50	4.5	FOR DJT	188,00 €
	AFM45C-XN0806-D125-B40-Z08	125	8	40	63	4.5	INSERT.	225,00 €
	AFM45C-XN0806-D160-C40-Z10	160	10	40	63	4.5		338,00 €
	AFM45C-XN0806-D200-C60-Z12	200	12	60	63	4.5		488,00 €
 <p>75°</p>	AFM75C-SP12-D050-A22-Z04	50	4	22	42	8		112,00 €
	AFM75C-SP12-D063-A22-Z05	63	5	22	40	8		128,00 €
	AFM75C-SP12-D080-A27-Z06	80	6	27	50	8		153,00 €
	AFM75C-SP12-D100-A32-Z07	100	7	32	50	8	SPKN 1203..	184,00 €
	AFM75C-SP12-D125-B40-Z08	125	8	40	63	8	ISO	245,00 €
	AFM75C-SP12-D160-C40-Z09	160	9	40	63	8		306,00 €
	AFM75C-SP12-D200-C60-Z12	200	12	60	63	8		434,00 €
 <p>90°</p>	AFM90C-TP16-D050-A22-Z04	50	4	22	40	12		112,00 €
	AFM90C-TP16-D063-A22-Z06	63	6	22	45	12		128,00 €
	AFM90C-TP16-D080-A27-Z07	80	7	27	50	12	TP.. 1603..	153,00 €
	AFM90C-TP16-D100-A32-Z08	100	8	32	50	12	ISO	184,00 €
	AFM90C-TP16-D125-B40-Z08	125	8	40	63	12		245,00 €
	AFM90C-TP22-D063-A22-Z05	63	5	22	45	18		128,00 €
	AFM90C-TP22-D080-A27-Z06	80	6	27	50	18		153,00 €
	AFM90C-TP22-D100-A32-Z07	100	7	32	50	18	TP.. 2204..	184,00 €
	AFM90C-TP22-D125-B40-Z08	125	8	40	63	18	ISO	245,00 €
	AFM90C-TP22-D160-C40-Z09	160	9	40	63	18		306,00 €
	AFM90C-TP22-D200-C60-Z12	200	12	60	63	18		434,00 €
	AFM90C-TP22-D250-C60-Z15	250	15	60	63	18		612,00 €
	AFM90C-TP22-D315-D60-Z18	315	18	60	63	18		989,00 €

HIGH FEED MILLING TOOLS / HOCHVORSCHUBFRÄSER





	CODE / TYP	TOOL DIMENSIONS (mm) <small>MAß</small>					CUTTING INSERT <small>WENDE PLATTE</small>	PRICE / PREIS
		D	z	d	L	a		
 <p>0°</p>	NEW AHFM-BL0904-D040-A16-Z05-H	40	5	16	40	2	BLMP 0904..	109,00 €
	AHFM-BL0904-D050-A22-Z06-H	50	6	22	50	2	FOR TGTC	125,00 €
	AHFM-BL0904-D063-A22-Z05-H	63	5	22	50	2	INSERT.	157,00 €
	AHFM-BL0904-D063-A22-Z07-H	63	7	22	50	2		214,00 €
 <p>0°</p>	AHFM-BL1205-D050-A22-Z03-H	50	3	22	40	2	BLMP 1205..	209,00 €
	AHFM-BL1205-D063-A22-Z04-H	63	4	22	40	2	FOR TGTC	236,00 €
	AHFM-BL1205-D080-A27-Z05-H	80	5	27	50	2	INSERT.	278,00 €

HIGH FEED MILLING TOOLS / HOCHVORSCHUBFRÄSER

	CODE / TYP	TOOL DIMENSIONS (mm) <small>MAß</small>					CUTTING INSERT <small>WENDE PLATTE</small>	PRICE / PREIS
		D	z	d	L	a		
	AHFM-EN1004-D050-A22-Z05-H	50	5	22	50	1	ENMU 1004..	134,00 €
	AHFM-EN1004-D050-A22-Z06-H	50	6	22	50	1	FOR DJT	147,00 €
	AHFM-EN1004-D052-A22-Z06-H	52	6	22	50	1	INSERT.	147,00 €
	AHFM-EN1004-D063-A22-Z06-H	63	6	22	50	1		155,00 €
	AHFM-EP1003-D050-A22-Z08-H	50	8	22	40	1	EP.. 1003..	170,00 €
	AHFM-EP1003-D063-A22-Z08-H	63	8	22	40	1	ZPMT 1003..	179,00 €
							YPHW 1003.. FOR DJT INSERT.	
	AHFM-L003-D040-A16-Z06-H	40	6	16	40	1	LOGU 0303..	163,00 €
	AHFM-L003-D050-A22-Z07-H	50	7	22	40	1	FOR KYCR	192,00 €
	AHFM-L003-D063-A22-Z09-H	63	9	22	40	1	INSERT.	238,00 €
	AHFMC-JD1204-D052-A22-Z03-H	52	3	22	50	1.5		153,00 €
	AHFMC-JD1204-D052-A22-Z04-H	52	4	22	50	1.5	JDMW 1204..	173,00 €
	AHFMC-JD1204-D063-A22-Z05-H	63	5	22	50	1.5	FOR MTSBSH	199,00 €
	AHFMC-JD1204-D080-A27-Z06-H	80	6	27	50	1.5	INSERT.	235,00 €
	AHFMC-JD1204-D100-A32-Z07-H	100	7	32	50	1.5		275,00 €
	AHFMC-JD1405-D052-A22-Z03-H	52	3	22	40	2	JDMW 1405..	173,00 €
	AHFMC-SD1204-D050-A22-Z04-H	50	4	22	40	1.8	SD.. 1204..	151,00 €
	AHFMC-SD1204-D063-A22-Z05-H	63	5	22	40	1.8	FOR ZCC	175,00 €
	AHFMC-SD1204-D080-A27-Z06-H	80	6	27	50	1.8	INSERT.	240,00 €
	AHFMC-SD1204-D100-A32-Z08-H	100	8	32	50	1.8		291,00 €
	AHFM-SD1205-D052-A22-Z04-H	52	4	22	50	2	SD.. 1205..	180,00 €
	AHFM-SD1205-D052-A22-Z05-H	52	5	22	50	2	FOR HTCH	195,00 €
	AHFM-SD1205-D066-A22-Z05-H	66	5	22	50	2	INSERT.	219,00 €
	AHFM-SD1205-D066-A22-Z06-H	66	6	22	50	2		234,00 €
	AHFM-SD1205-D080-A27-Z06-H	80	6	27	70	2		253,00 €

HIGH FEED MILLING TOOLS / HOCHVORSCHUBFRÄSER



110/111

	CODE / TYP	TOOL DIMENSIONS (mm) <i>MAß</i>					CUTTING INSERT WENDE PLATTE	PRICE / PREIS
		D	z	d	L	a		
	AHFM-SO1004-D050-A22-Z05-H	50	5	22	50	1.5	SOMT 1004..	175,00 €
	AHFM-SO1004-D063-A22-Z06-H	63	6	22	50	1.5	FOR KYCR	200,00 €
	AHFM-SO1004-D080-A27-Z07-H	80	7	27	63	1.5	INSERT.	248,00 €
	AHFM-SP1004-D050-A22-Z05-H	50	5	22	50	9.4	SPNW 1004..	181,00 €
	AHFM-SP1004-D052-A22-Z05-H	52	5	22	50	9.4	FOR DJT	181,00 €
	AHFM-SP1004-D063-A22-Z06-H	63	6	22	50	9.4	INSERT.	200,00 €
	AHFMC-WD06T3D-D042-A16-Z04-H	42	4	16	45	1.5	WD.W 06T3..	155,00 €
	AHFMC-WD06T3D-D050-A22-Z05-H	50	5	22	50	1.5	FOR DJT	164,00 €
	AHFMC-WD06T3D-D052-A22-Z05-H	52	5	22	50	1.5	INSERT.	168,00 €
	AHFMC-WD0805D-D052-A22-Z04-H	52	4	22	50	2		164,00 €
	AHFMC-WD0805D-D063-A22-Z05-H	63	5	22	50	2	WD.W 0805..	186,00 €
	AHFMC-WD0805D-D063-A27-Z05-H	63	5	27	50	2	FOR DJT	186,00 €
	AHFMC-WD0805D-D066-A27-Z05-H	66	5	27	50	2	INSERT.	199,00 €
	AHFMC-WD0805D-D080-A27-Z05	80	5	27	50	2		224,00 €
	AHFMC-WD0805D-D100-A32-Z06	100	6	32	50	2		286,00 €
	AHFMC-WD10X6D-D125-B40-Z06	125	6	40	63	2.5	WD.W 10X6..	314,00 €
AHFMC-WD10X6D-D160-C40-Z07	160	7	40	63	2.5	FOR DJT	393,00 €	
						INSERT.		
	AHFMC-WD0804-D040-A16-Z04-H	40	4	16	40	-	WDMT 0804..	165,00 €
	AHFMC-WD0804-D050-A22-Z04-H	50	4	22	50	-	SMTM	184,00 €
	AHFMC-WD1205-D050-A22-Z04-H	50	4	22	50	-	WDMT 1205..	170,00 €
	AHFMC-WD1205-D052-A22-Z04-H	52	4	22	50	-	FOR SMTM	170,00 €
	AHFMC-WD1205-D063-A22-Z05-H	63	5	22	50	-	INSERT.	200,00 €
	AHFMC-WD1205-D080-A27-Z06-H	80	6	27	63	-		231,00 €
	AHFM-WN0907-D050-A22-Z04-H	50	4	22	50	3	WNMU 0907..	183,00 €
	AHFM-WN0907-D052-A22-Z04-H	52	4	22	50	3	FOR DJT	174,00 €
	AHFM-WN0907-D063-A22-Z05-H	63	5	22	50	3	INSERT.	197,00 €
	AHFM-WN0907-D066-A27-Z05-H	66	5	27	50	3		209,00 €
	AHFM-WN0907-D080-A27-Z06-H	80	6	27	50	3		261,00 €
	AHFM-WN0907-D100-A32-Z07-H	100	7	32	50	3		314,00 €

HIGH FEED MILLING TOOLS / HOCHVORSCHUBFRÄSER

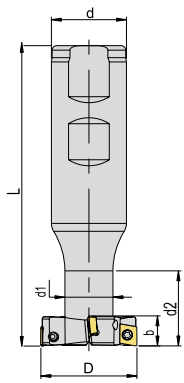

	CODE / TYP	TOOL DIMENSIONS (mm) MAß					CUTTING INSERT WENDE PLATTE	PRICE / PREIS
		D	z	d	L	a		
	AHFM-WN09T3-D040-A16-Z04-H	40	4	16	40	1.5	WNMX 09T3..	159,00 €
	AHFML-WN09T3-D040-A16-Z04-H	40	4	16	40	1.5		159,00 €
	AHFM-WN09T3-D050-A22-Z05-H	50	5	22	40	1.5	FOR KRLY	191,00 €
	AHFML-WN09T3-D050-A22-Z05-H	50	5	22	40	1.5	INSERT.	191,00 €
	AHFM-WN09T3-D063-A22-Z06-H	63	6	22	40	1.5		215,00 €

T - SLOT MILLING / T - NUTENFRÄSER

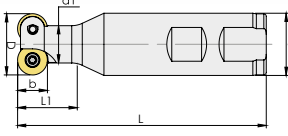
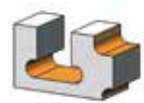
	CODE / TYP	TOOL DIMENSIONS (mm) MAß							CUTTING INSERT WENDE PLATTE	PRICE / PREIS
		Z TOTAL LENGTH	D	b	d	L	d ₁	d ₂		
 	ATSM90-CC06-D17X8-W16-L85-Z02	2-1	17	8	16	85	10	16		102,00 €
	ATSM90-CC06-D28X8-W20-L66-Z04	4-2	28	8	20	66	14	15.5		158,00 €
	ATSM90-CC06-D32X8-W25-L100-Z04	4-2	32	8	25	100	16	23	135,00 €	
	ATSM90-CC06-D45.5X8-W25-L100-Z06	6-3	45.5	8	25	100	12	30	240,00 €	
	ATSM90-CC06-D63X8-W32-L125-Z08	8-4	63	8	32	125	31.5	30	225,00 €	
	ATSM90-CC06-D18X9-W16-L90-Z02	2-1	18	9	16	90	10	16	CC.. 0602..	102,00 €
	ATSM90-CC06-D20X9-W16-L85-Z04	4-2	20	9	16	85	10	16	ISO	129,00 €
	ATSM90-CC06-D23X10-W20-L90-Z04	4-2	23	10	20	90	12	25		134,00 €
	ATSM90-CC06-D32X10-W25-L100-Z04	4-2	32	10	25	100	16	25		135,00 €
	ATSM90-CC06-D45X10-W32-L120-Z06	6-3	45	10	32	120	20	25		169,00 €
	ATSM90-CC06-D25X11-W25-L100-Z04	4-2	25	11	25	100	13	20		134,00 €
	ATSM90-CC09-D30X12-W25-L100-Z04	4-2	30	12	25	100	16	25		146,00 €
	ATSM90-CC09-D32X12-W25-L100-Z02	2-1	32	12	25	100	16	25	CC.. 09T3..	144,00 €
	ATSM90-CC09-D32X12-W25-L100-Z04	4-2	32	12	25	100	16	25	ISO	156,00 €
	ATSM90-CC09-D32X14-W25-L100-Z04	4-2	32	14	25	100	16	25		156,00 €
	ATSM90-CC09-D37X16-W32-L120-Z04	4-2	37	16	32	120	17	30		147,00 €
	ATSM90-CC09-D42X17-W32-L120-Z04	4-2	42	17	32	120	19	30		157,00 €
	ATSM90-CC09-D40X17-W32-L120-Z04	4-2	40	17	32	120	19	30		157,00 €
	ATSM90-CC12-D47X20-W32-L120-Z04	4-2	47	20	32	120	25	45		169,00 €
	ATSM90-CC12-D52X21-W32-L120-Z04	4-2	52	21	32	120	25	45	CC.. 1204..	192,00 €
ATSM90-CC12-D50X22-W32-L120-Z04	4-2	50	22	32	120	25	45	ISO	180,00 €	
ATSM90-CC12-D55X22-W32-L120-Z04	4-2	55	22	32	120	25	45		202,00 €	
	ATSM90-SP.05-D22.5X5-W25-L100-Z04	4-2	22.5	5	25	100	12	25	SPMG 050204	173,00 €
	ATSM90-SP.05-D30X5-W25-L100-Z04	4-2	30	5	25	100	10	25	FOR TGTC INSERT.	245,00 €
	ATSM90-SPGT0502-D63X6-W32-L125-Z10	10-5	63	6	32	125	31	30	SPGT 050204	270,00 €
	ATSM90-SPGT0904-D32X14-W32-L120-Z04-H	4-2	32	14	32	120	17.5	30	SPGT 090408	147,00 €
	ATSM90-SPGT0904-D37X16-W32-L120-Z04-H	4-2	37	16	32	120	21	40	FOR ZCC INSERT.	147,00 €
	ATSM90-SPGT0904-D42X17-W32-L120-Z04-H	4-2	42	17	32	120	21	40		157,00 €
	ATSM90-SPGT1104-D47X20-W32-L120-Z04-H	4-2	47	20	32	120	24	45	SPGT 110408	169,00 €
	ATSM90-SP.06-D80X7-W32-L120-Z10	10-5	80	7	32	120	32	30	SPMG 060204	663,00 €
								FOR TGTC INSERT.		

	CODE / TYP	TOOL DIMENSIONS (mm) MAß							CUTTING INSERT WENDE PLATTE	PRICE / PREIS
		Z	D	b	d	L	d ₁	L ₁		
  	ATSMR-RD0702-D17-W16-L90-Z02	2	17	7	16	90	10	12	RD.. 0702..	128,00 €
	ATSMR-RD0702-D25-W16-L90-Z03	3	25	7	16	90	15	12	ISO	148,00 €
	ATSMR-RD0702-D35-W25-L100-Z05	5	35	7	25	100	20	20		179,00 €
	ATSMR-RD1003-D21-W25-L100-Z02	2	21	10	25	100	12	20	RD.. 1003..	133,00 €
	ATSMR-RD1003-D80-W32-L165-Z06-H	6	80	10	32	165	30	31.5		734,00 €
	ATSMR-RD12T3-D25-W25-L100-Z02	2	25	12	25	100	15	24	RD.. 12T3..	138,00 €
	ATSMR-RD12T3-D80-W32-L165-Z06-H	6	80	12	32	165	30	31.5		734,00 €
	ATSMR-RD1604-D34-W32-L110-Z02	2	34	16	32	110	20	30	RD.. 1604..	143,00 €
								ISO		

SLOT DISC MILLING / SCHEIBENFRÄSER

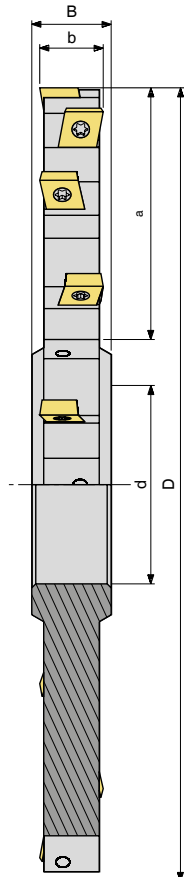
	CODE / TYP	TOOL DIMENSIONS (mm) <small>MAß</small>						CUTTING INSERT <small>WENDE PLATTE</small>	PRICE / PREIS
		<small>TOTAL EFFECTIVE</small>	D	b	a	d	B		
 <p>90°</p>	ASDM-SPGT05-D80x6-d27-Z10	10-5	80	6	17	27	10	SPGT 0502..	190,00 €
	ASDM-SPGT05-D100x6-d32-Z12	12-6	100	6	25	32	10	FOR ZCC	223,00 €
	ASDM-SPGT05-D125x6-d40-Z14	14-7	125	6	35	40	10	INSERT.	337,00 €
	ASDM-SPGT05-D160x6-d40-Z18	18-9	160	6	52	40	10		448,00 €
	ASDM-SPGT06-D80x7-d27-Z10	10-5	80	7	17	27	11		190,00 €
	ASDM-SPGT06-D100x7-d32-Z12	12-6	100	7	25	32	11	SPGT 0602..	223,00 €
	ASDM-SPGT06-D125x7-d40-Z14	14-7	125	7	35	40	11	FOR ZCC	337,00 €
	ASDM-SPGT06-D160x7-d40-Z16	16-8	160	7	52	40	11	INSERT.	448,00 €
	ASDM-SPGT06-D200x7-d40-Z18	18-9	200	7	70	40	11		560,00 €
  <p>90°</p>	ASDM-CC06-D80x8-d27-Z10	10-5	80	8	17	27	12		190,00 €
	ASDM-CC06-D100x8-d32-Z12	12-6	100	8	25	32	12		223,00 €
	ASDM-CC06-D125x8-d40-Z14	14-7	125	8	35	40	12		337,00 €
	ASDM-CC06-D160x8-d40-Z16	16-8	160	8	52	40	12		448,00 €
	ASDM-CC06-D200x8-d40-Z18	18-9	200	8	70	40	12	CC.. 0602..	560,00 €
	ASDM-CC06-D80x10-d27-Z10	10-5	80	10	17	27	14	ISO	190,00 €
	ASDM-CC06-D100x10-d32-Z12	12-6	100	10	25	32	14		223,00 €
	ASDM-CC06-D125x10-d40-Z14	14-7	125	10	35	40	14		337,00 €
	ASDM-CC06-D160x10-d40-Z16	16-8	160	10	52	40	14		448,00 €
	ASDM-CC06-D200x10-d40-Z18	18-9	200	10	70	40	14		560,00 €
	ASDM-CC09-D80x12-d27-Z08	8-4	80	12	17	27	16		190,00 €
	ASDM-CC09-D100x12-d32-Z10	10-5	100	12	25	32	16		223,00 €
	ASDM-CC09-D125x12-d40-Z12	12-6	125	12	35	40	16		337,00 €
	ASDM-CC09-D160x12-d40-Z14	14-7	160	12	52	40	16		448,00 €
	ASDM-CC09-D200x12-d40-Z16	16-8	200	12	70	40	16	CC.. 09T3..	560,00 €
	ASDM-CC09-D80x14-d27-Z08	8-4	80	14	17	27	18	ISO	190,00 €
	ASDM-CC09-D100x14-d32-Z10	10-5	100	14	25	32	18		223,00 €
	ASDM-CC09-D125x14-d40-Z12	12-6	125	14	35	40	18		337,00 €
	ASDM-CC09-D160x14-d40-Z14	14-7	160	14	52	40	18		448,00 €
	ASDM-CC09-D200x14-d40-Z16	16-8	200	14	70	40	18		560,00 €
	ASDM-CC12-D80x16-d27-Z06	6-3	80	16	17	27	20		190,00 €
	ASDM-CC12-D100x16-d32-Z08	8-4	100	16	25	32	20		223,00 €
	ASDM-CC12-D125x16-d40-Z10	10-5	125	16	35	40	20		337,00 €
	ASDM-CC12-D160x16-d40-Z12	12-6	160	16	52	40	20		448,00 €
	ASDM-CC12-D200x16-d40-Z14	14-7	200	16	70	40	20		560,00 €
	ASDM-CC12-D80x18-d27-Z06	6-3	80	18	17	27	22		190,00 €
	ASDM-CC12-D100x18-d32-Z08	8-4	100	18	25	32	22		223,00 €
	ASDM-CC12-D125x18-d40-Z10	10-5	125	18	35	40	22	CC.. 1204..	337,00 €
	ASDM-CC12-D160x18-d40-Z12	12-6	160	18	52	40	22	ISO	448,00 €
	ASDM-CC12-D200x18-d40-Z14	14-7	200	18	70	40	22		560,00 €
	ASDM-CC12-D250x18-d40-Z16	16-8	250	18	90	40	22		784,00 €
	ASDM-CC12-D80x20-d27-Z06	6-3	80	20	17	27	24		190,00 €
ASDM-CC12-D100x20-d32-Z08	8-4	100	20	25	32	24		223,00 €	
ASDM-CC12-D125x20-d40-Z10	10-5	125	20	35	40	24		337,00 €	
ASDM-CC12-D160x20-d40-Z12	12-6	160	20	52	40	24		448,00 €	
ASDM-CC12-D200x20-d40-Z14	14-7	200	20	70	40	24		560,00 €	
ASDM-CC12-D250x20-d40-Z16	16-8	250	20	90	40	24		784,00 €	

User's Guide For AKKO U-Drills

Before connecting your U-Drill to CNC lathe, you have to check if the turret is eccentric from the center or not. If there is any eccentricity in your turret, never use your U-Drill;

Processes that should be done to fix the turret :

1. A cylindrical part whose surface is precision and whose length and diameter is the same with the U-Drill that you will use, should be mounted to the holder of turret and X value of the lathe should be brought to zero (0).
2. Comparator should be mounted to chuck. The end of the comparator should be contacted (touched) to the surface of the part that we mounted on the turret.
3. The comparator that we mounted on the chuck should be turned 360-degree with the chuck and turret should be zeroed by that turning according to changing rate of comparator.

Cutting Speed and Revolution That are Needed For Using (Running) Your U-DRILLS More Productively

Grup No.	Material	Material Type	Cutting Speed Vc (m/m)
1	Non-alloy steel and free cutting steel	C1010. Automat etc.	220
2	Low alloy steel and cast steel	C1030 - 106 etc.	200
3	Alloy steel and tool steel	CK-45, 4140, 7131 etc.	170
4	Hot Work Steel and Stainless Steel	Impax etc.	150

P.S. : The cutting speed may be concerned with the type of the insert that you use.

Fistly, choose the material to make calculation of revolution. You should multiply the cutting speed (Vc) of the material that you chose by 1000 and divide by 3.14. You should divide the value that you found by the diameter of U-Drill. For Example : If our material is alloy steel and tool steel (3rd group), diameter of the U-Drill is 25 mm, cutting speed is 170, we should calculate as following: $170 \times 1000 = 170000 / 3.14 = 54140$, $54140 / 25 = 2166$ rpm is the result that we found (Spindle Speed) Feed rate of the lathe is concerned with the U-Drill that you will use and changes between 0.05 and 0.10. The user sets it according to cut of cutting insert.

Feed Calculation For Central Machine :

2166 spindle speed, that we found as a result of above mentioned calculation, should be multiplied by cutting insert feed (mm/r) between 0.05 and 0.10 feed choisses. Example 1 : $2166 \times 0.05 = 108$

Example 2 : $2116 \times 0.10 = 217$ The results 108 and 217 are the feed mm/m calculation for central machine.

Note: Cooling water pressure of lathe must be minimum 6 bar for our D4 u-drills and u-drills longer than D4.

Calculating Spindle Speed and Feed Rate For Milling Process

Vc.	S	D	F	Z	fz	FORMULAS
Cutting Speed (Please read from the back-side of cutting insert box)	Spindle Revolution rpm	Milling Tool Diameter	Feed Rate	Number of Effective Tooth	Feed Per Tooth (Please Read From The Back Side of Cutting Insert Box)	Calculation of Revolution : $S = (Vc \times 1000) / (3.14 \times D)$ Feed Rate Calculation : $F = S \times Z \times fz$

For Example : We will make milling with milling tool whose diamention is D 50 mm, whose theeth number is Z=5. The spindle revolution was written as Vc=200m/mn at the back side of cutting insert box. Let's calculate the revolution that should be entered to the milling machine : Vc=200 m/mn D=50 mm

S = Firstly Cutting Speed is multiplied with 1000, the result should be divided by 3.14 , the last result should be divided by diameter of milling tool.

$S = 200 \times 1000 = 200000 \rightarrow 200000 / 3.14 = 63663 \rightarrow 63663 / 50 = 1273$ rev S=1273 rev / mn

After finding spindle revolution, let's find feed rate : milling tool with Z=5 teeth and we read fz=0,12 from the back side of cutting insert box.

F = Tooth number should be multiplied with revolution, the result should be multiplied with feed per tooth.

$F = 1273 \times 5 = 6365 \rightarrow 6365 \times 0,12 = 763$ F = 763 mm / mn

Revolution that should be entered to the milling machine = S 1273 Feed Rate that should be entered to the milling machine = F 763 average value.

P.S : The values Vc and fz has to be written at the back side of the cutting insert. If these values were not written on the cutting insert box, please find them from cutting insert catalogue. If the material that you will work is steel, please read Vc and fz values that were written on the part P, if it is stainless steel please read from the part M, if it is cast iron please read from the part K.

Recommended Tightening Torque

- Read below information before tightening the tool.
- Check screw set's the screw size and together with mounting arbor inner dimension of screws.
- When tightening head to an arbor, follow the related tightening torque in the table.

Screw	Torque (N.m)
M6	8
M8	23
M10	46
M12	80
M16	90

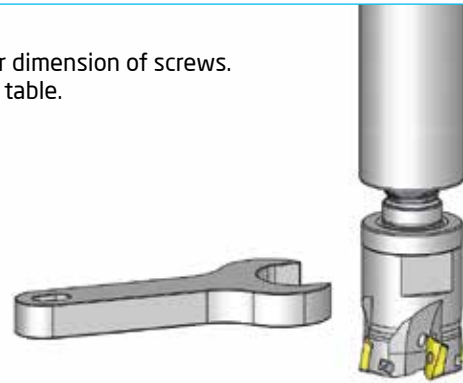

Internal Boring Bars Application Guide, Related to Body Material

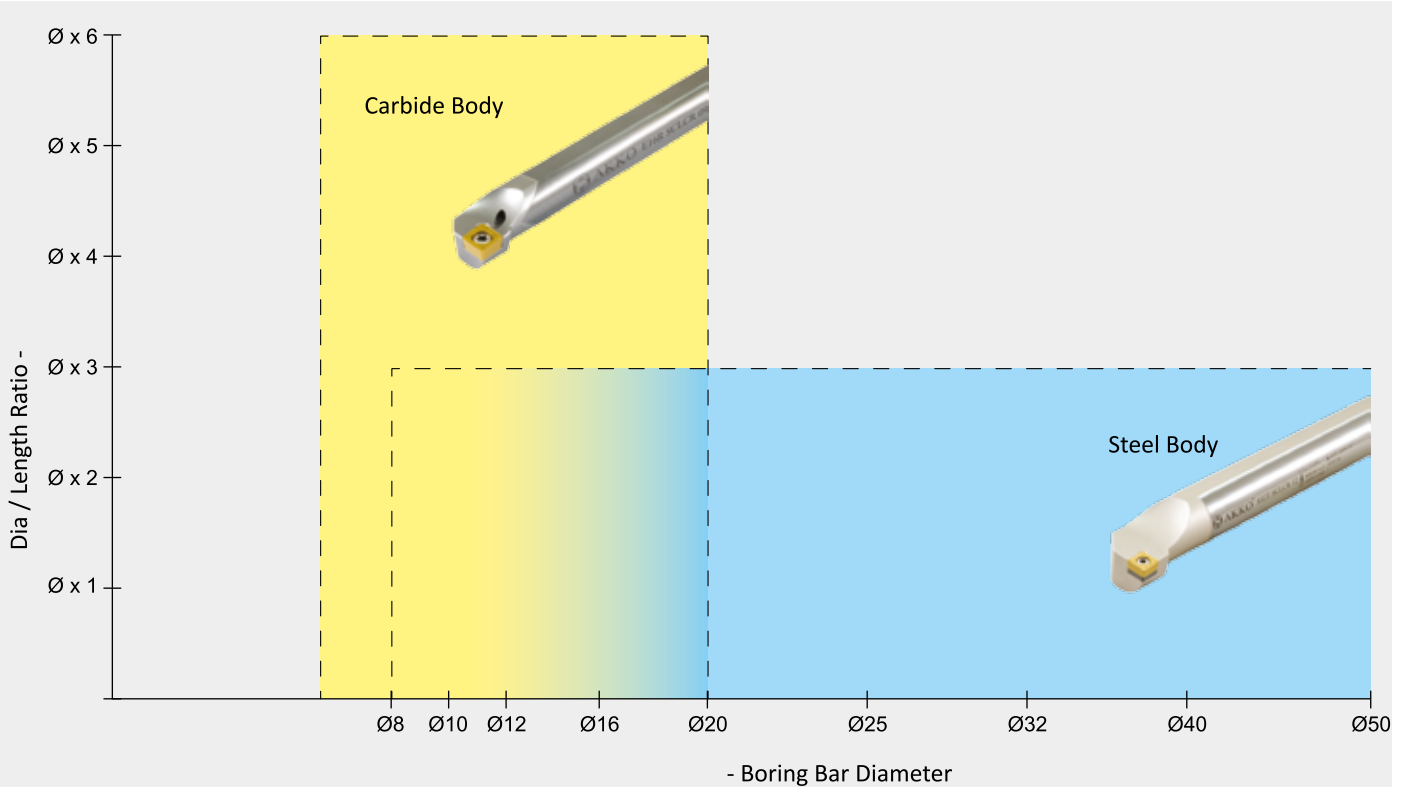

Application Guide For T-Slot Milling







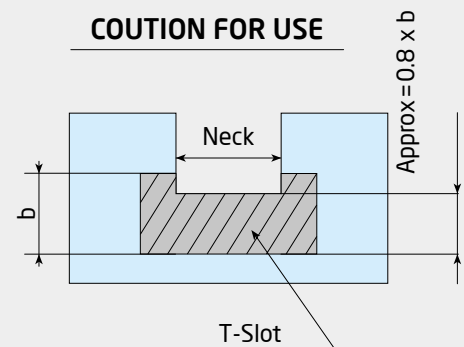



When T slot machining steel, the workpiece must be machined as shown in the drawing to ensure smooth chip evacuation.

Example: Before slotting with the T - slot milling cutter - code ATSM90-CC06-D32X10-W25-L100-Z04, The area of the neck of the tools to be worked and must be machined by End-Mill. In this case, it is very wrong to machining the slot completely. Bottom area ($0.8 \times b = 0.8 \times 10$) should be left 8 mm without machining. This area's operation must be machined by the T - slot milling cutter which is also necessary for the healthier work of the tool holder.

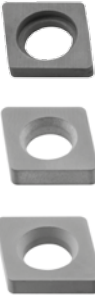
Slots to be machined must be free from chips for smooth machining.

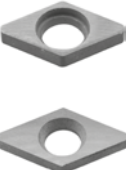

SPARE PARTS / ERSATZTEILE
SHIMS













PRODUCT PICTURE	CODE	PRODUCT DETAIL		PRICE / PREIS
	AATN-2-0001	For S-SYSTEM	TCMT 16 SHIM	5,40 €
	AATN-2-0002	For T-M SYSTEM For C-SYSTEM	TNMG 16 SHIM TNMG 16 SHIM	5,40 €
	AATN-3-0025	For P-SYSTEM	TNMG 16 SHIM	5,40 €
	AATN-3-0015	For T-M-P SYSTEM	TNMG 22 SHIM	5,60 €
	AATN-2-0020	For THREADING 16 SHIM		5,60 €
	AATN-2-0004	For THREADING 22 SHIM		7,10 €
	ATS-16E	For THREADING 16, EXTERNAL RIGHT - INTERNAL LEFT SHIM		8,00 €
	ATS-16I	For THREADING 16, EXTERNAL LEFT - INTERNAL RIGHT SHIM		8,00 €
	ATS-22E	For THREADING 22, EXTERNAL RIGHT - INTERNAL LEFT SHIM		11,00 €
	ATS-22I	For THREADING 22, EXTERNAL LEFT - INTERNAL RIGHT SHIM		11,00 €
	ATS-27E	For THREADING 27, EXTERNAL RIGHT - INTERNAL LEFT SHIM		20,40 €
	ATS-27I	For THREADING 27, EXTERNAL LEFT - INTERNAL RIGHT SHIM		20,40 €
	AACN-2-0001	For S-SYSTEM	CCMT 09 SHIM	5,40 €
		For T-SYSTEM	CNMG 09 SHIM	
	AACN-2-0002	For P-SYSTEM	CNMG 09 SHIM	5,40 €
	AACN-2-0003	For S-SYSTEM	CCMT 12 SHIM	5,60 €
	AACN-3-0001	For T-M-P SYSTEM	CNMG 12 SHIM	5,60 €
		For C-SYSTEM	CNGN 12 SHIM	
	AACN-3-0002	For T-P SYSTEM	CNMG 16 SHIM	7,70 €
	AACN-3-0003	For T-P SYSTEM	CNMG 19 SHIM	12,80 €
AACN-3-0008	For T-P SYSTEM	CNMG 25 SHIM	20,40 €	
	AAWN-2-0003	For T-M-P SYSTEM	WNMG 08 THICK SHIM	7,70 €
	AAWN-3-0001	For T-M-P SYSTEM	WNMG 08 SHIM	5,60 €
	AAWN-SW317	For T-M-P SYSTEM	WNMG 06 SHIM	5,40 €
	AKS-16L	For C-SYSTEM	KNUX-L 16 SHIM	5,60 €
	AKS-16R	For C-SYSTEM	KNUX-R 16 SHIM	5,60 €
	AASD-3-0001	For S-SYSTEM MILLING	SDMT 12 SHIM	7,70 €
	AASE-3-0001	For S-SYSTEM MILLING	SEMT 13 SHIM	7,70 €
	AASN-2-0001	For S-SYSTEM	SCMT 09 SHIM	5,40 €
	AASN-2-0002	For P-SYSTEM	SNMG 09 SHIM	5,40 €
	AASN-2-0004	For S-SYSTEM	SCMT 12 SHIM	5,60 €
	AASN-3-0004	For T-P SYSTEM	SNMG 12 SHIM	5,60 €
		For C-SYSTEM	SNGN 12 SHIM	
	AASN-3-0023	For T-P SYSTEM	SNMG 15 SHIM	7,70 €
	AASN-3-0005	For T-P SYSTEM	SNMG 19 SHIM	12,80 €
	AASN-3-0020	For T-P SYSTEM	SNMG 25 SHIM	20,40 €
	AASN-20020	For PSDNN CARTRIDGE	SNMG 12 SHIM	10,20 €
		AADN-2-0001	For S-SYSTEM	DCMT 11 SHIM
For T-SYSTEM			DNMG 11 SHIM	
AADN-SD317		For P-SYSTEM	DNMG 11 SHIM	5,40 €
AADN-3-0001		For T-M-P SYSTEM	DNMG 15 SHIM	5,60 €
	For C-SYSTEM	DNGN 15 SHIM		
AADN-2-0003	For T-SYSTEM	DNMG 15 THICK SHIM	7,70 €	
	AAVN-2-0002	For S-SYSTEM	VBMT 16, VCMT 16 SHIM	5,60 €
		For T-SYSTEM	VNMG 16 SHIM	
	AARC-3-0001	For C-SYSTEM	RCGX 06 SHIM	13,20 €
	AARC-3-0002	For C-SYSTEM	RCGX 09 SHIM	13,20 €
	AARC-3-0003	For C-SYSTEM	RCGX 12 SHIM	13,20 €

SPARE PARTS / ERSATZTEILE

CLAMPS

PRODUCT PICTURE	CODE	PRODUCT DETAIL		PRICE / PREIS
	ATK-01	For T-SYSTEM	DNMG 11, WNMG 06, TNMG 16, CNMG 09 CLAMP	6,60 €
	ATK-02	For T-SYSTEM	CNMG 12, WNMG 08, TNMG 22, DNMG 15, SNMG 12 CLAMP	6,60 €
	ATK-03	For T-SYSTEM	VNMG 16 CLAMP	6,60 €
	ATK-04	For T-SYSTEM	CNMG 16, SNMG 15 CLAMP	6,60 €
	AMK-01	For M-SYSTEM	WNMG 06 CLAMP	6,60 €
	AMK-02	For M-SYSTEM	INTERNAL Ø20 TNMG 16 Ø25 MT-NR/L 16 CLAMP	6,60 €
	AMK-03	For M-SYSTEM	DNMG 11, CNMG 12 CLAMP	6,60 €
	AMK-04	For M-SYSTEM	DNMG 15, TNMG 16-22 CLAMP	6,60 €
	AMK-05	For M-SYSTEM	WNMG 08 CLAMP	6,60 €
	AMK-07	For M-SYSTEM	S20R MCLNR/L CLAMP	6,60 €
	ACK-01-R	For C-SYSTEM	KNUX-R CLAMP	6,60 €
	ACK-02-L	For C-SYSTEM	KNUX-L CLAMP	6,60 €
	ACK-03	For C-SYSTEM	154.91 EXTERNAL and INTERNAL Ø25-Ø32 CLAMP	6,60 €
	ACK-04	For P-C-SYSTEM	CTFPR CARTRIDGE CLAMP	6,60 €
	ACK-05	For P-C-SYSTEM	ADDITIONAL LITTLE CLAMP for MILLING and THREADING TOOLS	6,60 €
	ACK-06	For C-SYSTEM	154.91 INTERNAL Ø16-Ø20 CLAMP	6,60 €
	ACK-07	For C-SYSTEM	SPARE PART SET of CNGN, SNGN, DNGN (CLAMP+CLAMP SCREW+RING)	12,10 €
	ACK-08	For C-SYSTEM	SPARE PART SET of TNGN, (CLAMP+CLAMP SCREW+RING)	12,10 €
	ACK-09	For P-SYSTEM	ADDITIONAL BIG CLAMP for CNMG 16-19, SNMG 15-19	6,60 €

SPARE PARTS / ERSATZTEILE
CLAMPS

PRODUCT PICTURE	CODE	PRODUCT DETAIL		PRICE / PREIS
	AKK-10	For C-SYSTEM MILLING	SPKN 12 ve Ø50-Ø63 TPKN 16 CLAMP (M8x8)	6,60 €
	AKK-11	For C-SYSTEM MILLING	Ø80-Ø100 TPKN 16-TPKN 22, OFKR 07, HNMX 09 CLAMP (M8x10)	6,60 €
	AKK-12	For C-SYSTEM	CTSPR CATRIDGE CLAMP	6,60 €
	AKK-15	For S-SYSTEM MILLING	RD.. 10-12 CLAMP	6,60 €
	AKK-19	For S-SYSTEM MILLING	WD0805D CLAMP	6,60 €
	AKK-23	For C-SYSTEM	SPARE PART SET of DNGN 11, (CLAMP+CLAMP SCREW+RING)	12,10 €
	AKK-24	For S-SYSTEM MILLING	XD0806D CLAMP	6,60 €
	AKK-26	For C-SYSTEM MILLING	XNMU 0806..CLAMP	6,60 €
	AKK-27	For C-SYSTEM	RCGX 06 CLAMP	13,20 €
	AKK-28	For C-SYSTEM	RCGX 09 CLAMP	13,20 €
	AKK-29	For C-SYSTEM	RCGX 12 CLAMP	13,20 €
	AKK-04	For GROOVING TOOLHOLDERS	ADKT-H22 - S312 - (0.5-2) CLAMP	13,20 €

SPARE PARTS / ERSATZTEILE

CLAMP SCREWS				
PRODUCT PICTURE	CODE	PRODUCT DETAIL		PRICE / PREIS
	AKV-01-M5X22	For T-SYSTEM	DNMG 11, WNMG 06, TNMG 16 CLAMP SCREW (M5X20)	1,80 €
	AKV-02-M6X22	For T-SYSTEM	CNMG 12, WNMG 08, TNMG 22, DNMG 15, SNMG 12-15 VNMG 16 CLAMP SCREW (M6X20)	1,80 €
		For M-SYSTEM	TNMG 16-22, DNMG 15 CLAMP SCREW (M6X20)	
	AKV-03-M6X22	For M-SYSTEM	WNMG 08 CLAMP SCREW (M6X20)	1,80 €
	AKV-04-M5X17	For M-SYSTEM	S20R MT-NR/L 16, S20R-S25S MWLNR/L 06, S25S MDUNR/L11- EXTERNAL MWLNR 06 (M5X20)	1,80 €
	AKV-05-M6X25	For T-SYSTEM	CNMG 16 CLAMP SCREW (M6X25)	1,80 €
	AKV-06-M6X20	For C-SYSTEM	KNUX 16 CLAMP SCREW (M6X20)	2,20 €
	AKV-07-M6X22	For C-SYSTEM	ADKT-154.91, AIKT-154.91-R/L-32 CLAMP SCREW (M6X20)	1,80 €
	AKV-10-M6X14	For C-SYSTEM	AIKT-154.91-R/L-16, AIKT-154.91-R/L-20, AIKT-154.91-R/L-25 CLAMP SCREW (M6X15)	1,80 €
	AKV-11-M8X29	For C-SYSTEM	TNGN, CNGN, DNGN, SNGN CLAMP SCREW (M8X33)	2,20 €
	AAV-05-M6X15	For P-SYSTEM	CNMG 16-19, SNMG 15-19 ADDITIONAL BIG CLAMP SCREW (M6X15)	1,80 €
	AKV-12-M5X12	For C-SYSTEM	CTSPR CLAMP SCREW (M5X9)	1,80 €
	AKV-13-M8X1X16	For C-SYSTEM MILLING	SPKN 12 ve Ø63 TPKN 16 CLAMP SCREW (M8X1X16)	2,20 €
	AKV-14-M8X1X18	For C-SYSTEM MILLING	Ø80-Ø100 TPKN 16 ve Ø63-Ø315 TPKN 22 CLAMP SCREW (M8X1X18)	2,20 €
	AKV-15-M8X1X20	For C-SYSTEM MILLING	OFKR 07, HNMX 09 CLAMP SCREW (M8X1X20)	2,20 €
	AKV-16-M6X16	For C-SYSTEM	CTFPR 13CS 16 CLAMP SCREW (M6X16)	2,20 €
	AKV-17-M5X15	For M-SYSTEM	S16P MWLNR/L CLAMP SCREW (M5X18)	1,80 €
	AKV-19-M7X25	For T-SYSTEM	CNMG 16 CLAMP SCREW (M7X25)	2,20 €
	AKV-20-M6X19	For M-SYSTEM	S25S MDUNR/L 15 CLAMP SCREW (M6X19)	1,80 €
	AKV-21-M6X18	For C-SYSTEM	AIKT-154.91-R/L-25 CLAMP SCREW (M6X18)	1,80 €
	AKV-22-M8X1X14	For C-SYSTEM MILLING	Ø50 TPKN 16 CLAMP SCREW (M8X1X14)	2,20 €
	AKV-26-M6X0.75X20	For C-SYSTEM MILLING	XNMU 0806.. CLAMP SCREW	2,20 €
	AKV-27-M6X20	For M-SYSTEM	S25S MWLNR/L 08 CLAMP SCREW	1,80 €

SPARE PARTS / ERSATZTEILE
SHIM SCREWS

PRODUCT PICTURE	CODE	PRODUCT DETAIL		PRICE / PREIS
	AAV-01-M3X10	For T-SYSTEM	WNMG 06, KNUX 16 SHIM SCREW	1,10 €
	AAV-02-M5X12	For T-SYSTEM	CNMG 12, WNMG 08, TNMG 22, DNMG 15, SNMG 12	1,10 €
		For C-SYSTEM	CNGN 12, SNGN 12, DNGN 15 SHIM SCREW	
	AAV-03-M5X12	For T-SYSTEM	TNMG 16 SHIM SCREW	1,10 €
		For C-SYSTEM	TNGN 16 SHIM SCREW	
	AAV-04-M5X12	For T-SYSTEM	VNMG 16, DNMG 11, CNMG 09 SHIM SCREW	1,10 €
	AAV-05-M6X15	For T-SYSTEM	CNMG 16 SHIM SCREW	1,80 €
	AAV-06-M3.5X11	For S-SYSTEM	CCMT 09, DCMT 11, VBMT 16, VCMT 16	3,30 €
			TCMT 16, For THREADING 16 SHIM SCREW (M3.5 SHIM SCREW)	
	AAV-07-M4.5X13	For S-SYSTEM	CCMT 12, SCMT 12, For THREADING 22	3,30 €
			SHIM SCREW (M4.5 SHIM SCREW)	
	AAV-08-M3.5X8	For S-SYSTEM	(M3.5x8 SHIM SCREW)	3,30 €
	AAV-09-M5X9	For T-SYSTEM	S25S TCLNR/L 09, S25S TDUNR/L 11, S25S TDQNR/L 11 SHIM SCREW	1,10 €
	AAV-10-M4.5X8	For S-SYSTEM	(M4.5x8 SHIM SCREW)	3,30 €
	AAV-11-U5-40X4.5	For S-SYSTEM	For THREADING TOOLHOLDERS 16 ER/L, 16 IR/L SHIM SCREW	2,20 €
	AAV-12-U8-32X5.5	For S-SYSTEM	For THREADING TOOLHOLDERS 22 ER/L, 22 IR/L SHIM SCREW	2,20 €
AAV-13-M5X8	For T-SYSTEM	S25S TSKNR/L 12, S25S TCLNR/L 12, S25S TWLNR/L 08 SHIM SCREW	1,10 €	
AAV-14-M5X20	For ATUM	ADCR CHAMFERING RING TOOLS MOUNTING SCREW	1,10 €	
AAV-15-M5X5.7	For S-SYSTEM	For THREADING TOOLHOLDERS 27 ER/L, 27 IR/L SHIM SCREW	2,20 €	
AAV-16-M3.5X8	For S-SYSTEM	SEMT 13 SHIM SCREW	3,30 €	

PINS

PRODUCT PICTURE	CODE	PRODUCT DETAIL		PRICE / PREIS
	APM-01	For M-SYSTEM	INTERNAL Ø25-Ø32-Ø40 and EXTERNAL TNMG 16 PIN	2,20 €
	APM-02	For M-SYSTEM	TNMG 22, WNMG 08 PIN	2,20 €
	APM-03	For M-SYSTEM	S20R MTFNR/L 16, S20R MT-NR/L 16, S20R MTUNR/L 16, S20R MTQNR/L 16, S20R MDUNR/L 11PIN	2,20 €
	APM-04	For M-SYSTEM	S32T MCLNR/L 12, DNMG 15, S25S MWLNR/L 08 PIN	2,20 €
	APM-05	For M-SYSTEM	MSYNR 11.5CS 12 For CARTRIDGE SNMG 12 PIN	4,40 €
	APM-06	For C-SYSTEM	154.91 PIN	2,20 €
	APM-07	For M-SYSTEM	S20R ET-NR 16 PIN	6,60 €
	APM-08	For M-SYSTEM	S25S MWLNR/L 06, EXTERNAL PIN	2,20 €
	APM-09	For M-SYSTEM	S16P MWLNR/L 06 PIN	2,20 €
	APM-10	For M-SYSTEM	S20R MWLNR/L 06 PIN	2,20 €
	APM-11	For M-SYSTEM	S20R MTQNR/L 16 PIN	2,20 €
	APM-12	For M-SYSTEM	S20R MCLNR/L 12, S25S MCLNR/L 12-Z PIN	2,20 €
	APM-13	For M-SYSTEM	S25S MCLNR/L 12 PIN	2,20 €
	APM-14	For M-SYSTEM	S25S MTFNR/L 16, S25S MT-NR/L 16, S25S MTUNR/L 16, S25S MTQNR/L 16 PIN	2,20 €
	APM-15	For M-SYSTEM	MSYNR 16CS 12 For CARTRIDGE SNMG 12 PIN	4,40 €

SPARE PARTS / ERSATZTEILE

RING

PRODUCT PICTURE	CODE	PRODUCT DETAIL		PRICE / PREIS
	ACS-01	For C-SYSTEM	TNGN, CNGN, DNGN, SNGN, RING	1,10 €

STAMP

PRODUCT PICTURE	CODE	PRODUCT DETAIL		PRICE / PREIS
	ABPL-01	For T-SYSTEM	DNMG 11-15, WNMG 06-08, TNMG 16-22, VNMG 16, CNMG 12, SNMG 12 STAMP	0,20 €
		For M-SYSTEM	INTERNAL Ø25-Ø32-Ø40 and EXTERNAL TNMG 16-22, DNMG 15, WNMG 08 STAMP	
	ABPL-02	For C-SYSTEM	KNUX 16 STAMP	0,20 €
	For T-SYSTEM	CNMG 16 STAMP		

CLAMP SPRING

PRODUCT PICTURE	CODE	PRODUCT DETAIL		PRICE / PREIS
	AKY-01	For T-SYSTEM	CNMG 12, WNMG 08, TNMG 22, DNMG 15, SNMG 12, VNMG 16 CLAMP SPRING	1,10 €
	AKY-02	For C-SYSTEM	KNUX 16 CLAMP SPRING	1,10 €











LEVERS

PRODUCT PICTURE	CODE	PRODUCT DETAIL		PRICE / PREIS
	APL-01	For P-SYSTEM	CNMG 09, DNMG 11, SNMG 09, TNMG 16, WNMG 06 LEVER	7,70 €
	APL-02	For P-SYSTEM	CNMG 12, SNMG 12, TNMG 22, WNMG 08 LEVER	7,70 €
	APL-03	For P-SYSTEM	DNMG 15 LEVER	7,70 €
	APL-04	For P-SYSTEM	CNMG 16, SNMG 15 LEVER	7,70 €
	APL-05	For P-SYSTEM	CNMG 19, SNMG 19 LEVER	13,20 €
	APL-06	For P-SYSTEM	CNMG 25, SNMG 25 LEVER	19,80 €
	APL-07	For P-SYSTEM	S16P PCLNR/L 09, S16P PTUNR/L 16 LEVER	7,70 €
	APL-08	For P-SYSTEM	S16P PTUNR/L 16 LEVER	7,70 €

LEVER SCREWS

PRODUCT PICTURE	CODE	PRODUCT DETAIL		PRICE / PREIS
	ALV-01-M6X14	For P-SYSTEM	INTERNAL Ø20 DNMG 11 Ø20 TNMG 16 LEVER SCREW (M6X14)	2,60 €
	ALV-02-M6X17	For P-SYSTEM	DNMG 11, TNMG 16, WNMG 06 LEVER SCREW (M6X17)	2,60 €
	ALV-03-M8X19	For P-SYSTEM	CNMG 12, SNMG 12, TNMG 22, WNMG 08, DNMG 15 LEVER SCREW (M8X19)	2,60 €
	ALV-04-M8X22	For P-SYSTEM	CNMG 16, SNMG 15 LEVER SCREW (M8X22)	2,60 €
	ALV-05-M10X27	For P-SYSTEM	CNMG 19, SNMG 19 LEVER SCREW (M10X27)	3,10 €
	ALV-06-M12X36	For P-SYSTEM	CNMG 25, SNMG 25 LEVER SCREW (M12X36)	5,70 €
	ALV-07-M6X13	For P-SYSTEM	S16P PCLNR/L 09, S16P PCTUR/L 16 LEVER SCREW (M6X13)	2,60 €
	ALV-08-M8X17	For P-SYSTEM	S25S PCLNR/L 12, S25S PDUNR/L 15, S25S PSKNR/L 12 LEVER SCREW	2,60 €

SPARE PARTS / ERSATZTEILE
TORX SCREWS

PRODUCT PICTURE	CODE	PRODUCT DETAIL		PRICE / PREIS
	4006-M1.6X3.2	For S-SYSTEM	TORK SCREW	4,40 €
	3006-M1.8X4	For S-SYSTEM	TORK SCREW	5,50 €
	3006-M2X4	For S-SYSTEM	TORK SCREW	3,60 €
	4006-M2X5	For S-SYSTEM	TORK SCREW	2,20 €
	3007-M2.2X5	For S-SYSTEM	TORK SCREW	3,60 €
	4006-M2.2X5	For S-SYSTEM	TORK SCREW	2,20 €
	1008-M2.5X5	For S-SYSTEM	TORK SCREW	1,10 €
	1008-M2.5X7	For S-SYSTEM	TORK SCREW	1,10 €
	1108-M2.5x6	For S-SYSTEM	TORK SCREW	6,60 €
	3008-M2.5X5	For S-SYSTEM	TORK SCREW	3,60 €
	3008-M2.5X6	For S-SYSTEM	TORK SCREW	3,60 €
	4007-M2.5X4.5	For S-SYSTEM	TORK SCREW	2,20 €
	4008-M2.5X4	For S-SYSTEM	TORK SCREW	2,20 €
	4008-M2.5X4.5	For S-SYSTEM	TORK SCREW	2,20 €
	4008-M2.5X6	For S-SYSTEM	TORK SCREW	2,20 €
	4108-M2.5x6.5	For S-SYSTEM	TORK SCREW	2,20 €
	4108-M2.5x8	For S-SYSTEM	TORK SCREW	2,20 €
	1008-M3X6	For S-SYSTEM	TORK SCREW	1,10 €
	1008-M3X8	For S-SYSTEM	TORK SCREW	1,10 €
	3008-M3X6	For S-SYSTEM	TORK SCREW	3,60 €
	3008-M3X7	For S-SYSTEM	TORK SCREW	3,60 €
	3008-M3X8	For S-SYSTEM	TORK SCREW	3,60 €
	3108-M3X8	For S-SYSTEM	TORK SCREW	3,60 €
	4008-M3X8	For S-SYSTEM	TORK SCREW	2,20 €
	4010-M3X6	For S-SYSTEM	TORK SCREW	2,20 €
	4010-M3X8	For S-SYSTEM	TORK SCREW	2,20 €
	1015-M3.5X9	For S-SYSTEM	TORK SCREW	1,10 €
	1015-M3.5X11	For S-SYSTEM	TORK SCREW	1,10 €
	1015-M3.5X14	For S-SYSTEM	TORK SCREW	1,10 €
	1015-M3.5X16	For S-SYSTEM	TORK SCREW	1,10 €
	1315-M3.5X11	For S-SYSTEM	TORK SCREW	1,10 €
	1410-M3.5X9	For S-SYSTEM	TORK SCREW	1,10 €
	1510-M3.5X7	For S-SYSTEM	TORK SCREW	1,10 €
	1510-M3.5X9	For S-SYSTEM	TORK SCREW	1,10 €
	1615-M3.5X10	For S-SYSTEM	TORK SCREW	1,10 €
	1615-M3.5X11	For S-SYSTEM	TORK SCREW	1,10 €
	1615-M3.5X15	For S-SYSTEM	TORK SCREW	1,10 €
	3010-M3.5X7	For S-SYSTEM	TORK SCREW	3,60 €
	3010-M3.5X9	For S-SYSTEM	TORK SCREW	3,60 €
	3015-M3.5X9	For S-SYSTEM	TORK SCREW	3,60 €
	4015-M3.5X8	For S-SYSTEM	TORK SCREW	2,20 €
	4015-M3.5X9	For S-SYSTEM	TORK SCREW	2,20 €
	4015-M3.5X10	For S-SYSTEM	TORK SCREW	2,20 €
	4015-M3.5X11	For S-SYSTEM	TORK SCREW	2,20 €
	4015-M3.5X12	For S-SYSTEM	TORK SCREW	2,20 €
	4015-M3.5X14	For S-SYSTEM	TORK SCREW	2,20 €
	1015-M4X9	For S-SYSTEM	TORK SCREW	3,30 €
	1515-M4X9	For S-SYSTEM	TORK SCREW	1,10 €
	1115-M4x10	For S-SYSTEM	TORK SCREW	6,60 €
	1015-M4X11	For S-SYSTEM	TORK SCREW	3,30 €
	1315-M4X11	For S-SYSTEM	TORK SCREW	1,10 €
	1415-M4X11	For S-SYSTEM	TORK SCREW	1,10 €
	1515-M4X11	For S-SYSTEM	TORK SCREW	1,10 €
	1615-M4X11	For S-SYSTEM	TORK SCREW	1,10 €
	3015-M4X9	For S-SYSTEM	TORK SCREW	3,60 €
	3015-M4X11	For S-SYSTEM	TORK SCREW	3,60 €
	4015-M4X9	For S-SYSTEM	TORK SCREW	2,20 €
	4015-M4X11	For S-SYSTEM	TORK SCREW	2,20 €
	4015-M4X12	For S-SYSTEM	TORK SCREW	2,20 €
	4115-M4X12	For S-SYSTEM	TORK SCREW	2,20 €

SPARE PARTS / ERSATZTEILE

TORX SCREWS

PRODUCT PICTURE	CODE	PRODUCT DETAIL		PRICE / PREIS
	4515-M4X11	For S-SYSTEM	TORK SCREW	2,20 €
	4615-M4X11	For S-SYSTEM	TORK SCREW	2,20 €
	1015-M4.5X12	For S-SYSTEM	TORK SCREW	1,10 €
	1020-M4.5X16	For S-SYSTEM	TORK SCREW	1,10 €
	1120-M4.5X12	For S-SYSTEM	TORK SCREW	3,30 €
	1515-M4.5X11	For S-SYSTEM	TORK SCREW	1,10 €
	4015-M4.5X11	For S-SYSTEM	TORK SCREW	2,20 €
	4020-M4.5X10	For S-SYSTEM	TORK SCREW	2,20 €
	4020-M4.5X12	For S-SYSTEM	TORK SCREW	2,20 €
	1020-M5X11	For S-SYSTEM	TORK SCREW	1,10 €
	1120-M5X13	For S-SYSTEM	TORK SCREW	3,60 €
	1020-M5X14	For S-SYSTEM	TORK SCREW	1,10 €
	1520-M5X11	For S-SYSTEM	TORK SCREW	2,20 €
	1615-M5x14	For S-SYSTEM	TORK SCREW	3,30 €
	1620-M5X18	For S-SYSTEM	TORK SCREW	3,60 €
	1620-M5X22	For S-SYSTEM	TORK SCREW	3,60 €
	4420-M5X14	For S-SYSTEM	TORK SCREW	2,20 €
	1020-M6X16	For S-SYSTEM	TORK SCREW	1,50 €
	1420-M6X16	For S-SYSTEM	TORK SCREW	1,50 €
	1520-M6X16	For S-SYSTEM	TORK SCREW	1,50 €
1710-U5-40X12.2	For S-SYSTEM	TORK SCREW	3,60 €	
1720-U8-32X15	For S-SYSTEM	TORK SCREW	3,60 €	
1707-U4-48X8.2	For S-SYSTEM	TORK SCREW	5,50 €	

SHIM SPRING

PRODUCT PICTURE	CODE	PRODUCT DETAIL		PRICE / PREIS
	AAY-01	For P-SYSTEM	DNMG 11, TNMG 16, WNMG 06, CNMG 09, SNMG 09 SHIM SPRING	1,50 €
	AAY-02	For P-SYSTEM	CNMG 12, SNMG 12, TNMG 22, WNMG 08, DNMG 15 SHIM SPRING	1,50 €
	AAY-03	For P-SYSTEM	CNMG 16, SNMG 15 SHIM SPRING	1,50 €
	AAY-04	For P-SYSTEM	CNMG 19, SNMG 19 SHIM SPRING	1,50 €
	AAY-05	For P-SYSTEM	CNMG 25, SNMG 25 SHIM SPRING	2,90 €

PROFIL MILLING SCREWS

PRODUCT PICTURE	CODE	PRODUCT DETAIL		PRICE / PREIS
	1208-M3x7	PROFIL MILLING SCREW-P3208 INSERT SCREW		6,60 €
	1215-M4X0.5X9	PROFIL MILLING SCREW-P3210-ROHX 12 INSERT SCREW		6,60 €
	1220-M5X0.5X9	PROFIL MILLING SCREW-P3212 INSERT SCREW		6,60 €
	1220-M5X0.5X12	PROFIL MILLING SCREW-P3216-ROHX 16 INSERT SCREW		6,60 €
	1220-M5X0.5X15	PROFIL MILLING SCREW-P3220-ROHX 20 INSERT SCREW		6,60 €
	1220-M6X0.75X20	PROFIL MILLING SCREW-P3225 INSERT SCREW		8,80 €
	1204-M8X0.75X26	PROFIL MILLING SCREW-P3232 INSERT SCREW		11,00 €
	1210-M3.5X9.6	PROFIL MILLING SCREW-BNM 12 INSERT SCREW		11,00 €
	1215-M4X13.5	PROFIL MILLING SCREW-BNM 16 INSERT SCREW		11,00 €

SPARE PARTS / ERSATZTEILE
EXCENTRIC SCREW

PRODUCT PICTURE	CODE	PRODUCT DETAIL	PRICE / PREIS
	AEV-01-M6x16	CARTRIDGE EXCENTRIC SCREW	6,60 €

MOUNTING and ADJUSTING SCREWS

PRODUCT PICTURE	CODE	PRODUCT DETAIL	PRICE / PREIS
	2406-M8x30	A16 MOUNTING SCREW (SMALL HEAD)	1,80 €
	2506-M8x30	A16 MOUNTING SCREW	1,80 €
	2407-M10x30	A22 MOUNTING SCREW	1,80 €
	2408-M10x30	A22 MOUNTING SCREW (SMALL HEAD)	1,80 €
	2508-M10x30	A22 MOUNTING SCREW	1,80 €
	2408-M12x35	A27 MOUNTING SCREW	1,80 €
	2410-M12x35	A27 MOUNTING SCREW (SMALL HEAD)	1,80 €
	2510-M12x35	A27 MOUNTING SCREW	1,80 €
	2514-M16x35	A32 MOUNTING SCREW	1,80 €
	2504-M5x16	CARTRIDGE MOUNTING SCREW	1,80 €
	2505-M6x16	CARTRIDGE MOUNTING SCREW	1,80 €
	2505-M6x40	CARTRIDGE MOUNTING SCREW	1,80 €
	2506-M8x20	CARTRIDGE MOUNTING SCREW	1,80 €
	AKV-23-M4x10	CARTRIDGE MOUNTING SCREW	1,80 €
	2600-M4x9.5	CARTRIDGE AXIAL ADJUST SCREW	1,80 €
	2600-M5x13	CARTRIDGE AXIAL ADJUST SCREW	1,80 €
	2600-M6x18	CARTRIDGE AXIAL ADJUST SCREW	1,80 €
	2702-M4X4	CARTRIDGE RADIAL ADJUST SCREW	1,10 €
	2725-M5x6	CARTRIDGE RADIAL ADJUST SCREW	1,10 €
	2725-M5x10	CARTRIDGE RADIAL ADJUST SCREW	1,10 €

ALLEN KEYS

PRODUCT PICTURE	CODE	PRODUCT DETAIL	PRICE / PREIS
	AAL-01-2 mm	ALLEN KEY	1,10 €
	AAL-02-2.5 mm	ALLEN KEY	1,10 €
	AAL-03-3 mm	ALLEN KEY	1,10 €
	AAL-05-4 mm	ALLEN KEY	1,30 €
	AAL-07-5 mm	ALLEN KEY	1,80 €
	AAL-08-6 mm	ALLEN KEY	2,75 €
	AAL-09-1.5 mm	ALLEN KEY	1,10 €
	AAL-11-8 mm	ALLEN KEY	4,40 €
	AAL-12-10 mm	ALLEN KEY	6,60 €

TORX KEYS

PRODUCT PICTURE	CODE	PRODUCT DETAIL	PRICE / PREIS
	80-T6	TORX KEY	3,30 €
	80-T7	TORX KEY	3,30 €
	80-T8	TORX KEY	3,30 €
	80-T10	TORX KEY	3,30 €
	80-T15	TORX KEY	3,30 €
	80-T20	TORX KEY	3,30 €
	81-T15	T-TYPE TORX KEY	3,30 €
	81-T20	T-TYPE TORX KEY	3,30 €

SPARE PARTS / ERSATZTEILE

ROUGH BORING HEADS

PRODUCT PICTURE	CODE	PRODUCT DETAIL	PRICE / PREIS
	ABKS-D16	ABKS-D16 CARTRIDGE FIXING CLAMP	6,60 €
	ABKS-D20	ABKS-D20 CARTRIDGE FIXING CLAMP	6,60 €
	ABKS-D25	ABKS-D25 CARTRIDGE FIXING CLAMP	6,60 €
	ABKS-D32	ABKS-D32 CARTRIDGE FIXING CLAMP	6,60 €
	ABKS-D40	ABKS-D40 CARTRIDGE FIXING CLAMP	6,60 €
	ABKS-D50	ABKS-D50 CARTRIDGE FIXING CLAMP	11,00 €
	ABKS-D63	ABKS-D63 CARTRIDGE FIXING CLAMP	11,00 €
	ABKS-D80	ABKS-D80 CARTRIDGE FIXING CLAMP	11,00 €
	2525-M3X14	2525-M3X14 CARTRIDGE MOUNTING SCREW	1,80 €
	2503-M4X15	2503-M4X15 CARTRIDGE MOUNTING SCREW	1,80 €
	2503-M4X20	2503-M4X20 CARTRIDGE MOUNTING SCREW	1,80 €
	2504-M5X25	2504-M5X25 CARTRIDGE MOUNTING SCREW	1,80 €
	2505-M6X30	2505-M6X30 CARTRIDGE MOUNTING SCREW	1,80 €
	2506-M8X35	2506-M8X35 CARTRIDGE MOUNTING SCREW	1,80 €
	2508-M10X40	2508-M10X40 CARTRIDGE MOUNTING SCREW	1,80 €
	2510-M12X40	2510-M12X40 CARTRIDGE MOUNTING SCREW	1,80 €
	2715-M3X4	2715-M3X4 CARTRIDGE MOUNTING SCREW	1,10 €
	2715-M3X5	2715-M3X5 CARTRIDGE RADIAL ADJUST SCREW	1,10 €
	2715-M3X8	2715-M3X8 CARTRIDGE RADIAL ADJUST SCREW	1,10 €
	2702-M4X12	2702-M4X12 CARTRIDGE RADIAL ADJUST SCREW	1,10 €
2725-M5X12	2725-M5X12 CARTRIDGE RADIAL ADJUST SCREW	1,10 €	
2725-M5X14	2725-M5X14 CARTRIDGE RADIAL ADJUST SCREW	1,10 €	
2703-M6X16	2703-M6X16 CARTRIDGE RADIAL ADJUST SCREW	1,10 €	
2704-M8X25	2704-M8X25 CARTRIDGE RADIAL ADJUST SCREW	1,10 €	

GROOVING TOOLS SCREWS

PRODUCT PICTURE	CODE	PRODUCT DETAIL	PRICE / PREIS
	AKV-02-M6x20	GROOVING TOOL SCREW	1,80 €
	AKV-29-M6x28	GROOVING TOOL SCREW	3,30 €
	2503-M4x10	GROOVING TOOL SCREW	1,80 €
	2503-M4x16	GROOVING TOOL SCREW	1,80 €
	2504-M5x12	GROOVING TOOL SCREW	1,80 €
	2504-M5x16	GROOVING TOOL SCREW	1,80 €
	2505-M6x16	GROOVING TOOL SCREW	1,80 €
	2505-M6x20	GROOVING TOOL SCREW	1,80 €
	2004-M8x20	GROOVING TOOL SCREW	2,20 €
	2004-M8x1x20	GROOVING TOOL SCREW	2,20 €
	1904-M8x1x20	GROOVING TOOL SCREW	2,20 €

BLOCKS For PARTING and DEEP GROOVING BLADE CLAMPS

PRODUCT PICTURE	CODE	PRODUCT DETAIL	PRICE / PREIS
	ABK-01	For BLADE ALBU-20-26 CLAMP	22,00 €
	ABK-02	For BLADE ALBU-25-26 CLAMP	22,00 €
	ABK-03	For BLADE ALBU-20-32 CLAMP	24,20 €
	ABK-04	For BLADE ALBU-25-32, ALBU-32-32 CLAMP	24,20 €

BLADE KEY

PRODUCT PICTURE	CODE	PRODUCT DETAIL	PRICE / PREIS
	ALA-01	AKL BLADE KEY	13,20 €



α = 5 Kat Dayanıklılık

α = 5 Times Long Life

Alfa Kaplamanın Avantajları

Alpha Coating Advantages

- **Yüksek aşınma direnci**
High resistance to abrasion
- **Yüksek yüzey sertliği**
750-800 Vickers
High surface hardness
750-800 Vickers
- **Temperlemeye karşı yüksek direnç**
High resistance to tempering
- **Yüksek yorulma mukavemeti**
High fatigue strength
- **Yüksek çizik ve çentik direnci**
High scratch and impact resistance
- **Paslanmaz olmayan çelikler için daha yüksek korozyon direnci**
Resistant to corrosion of non-stainless steel

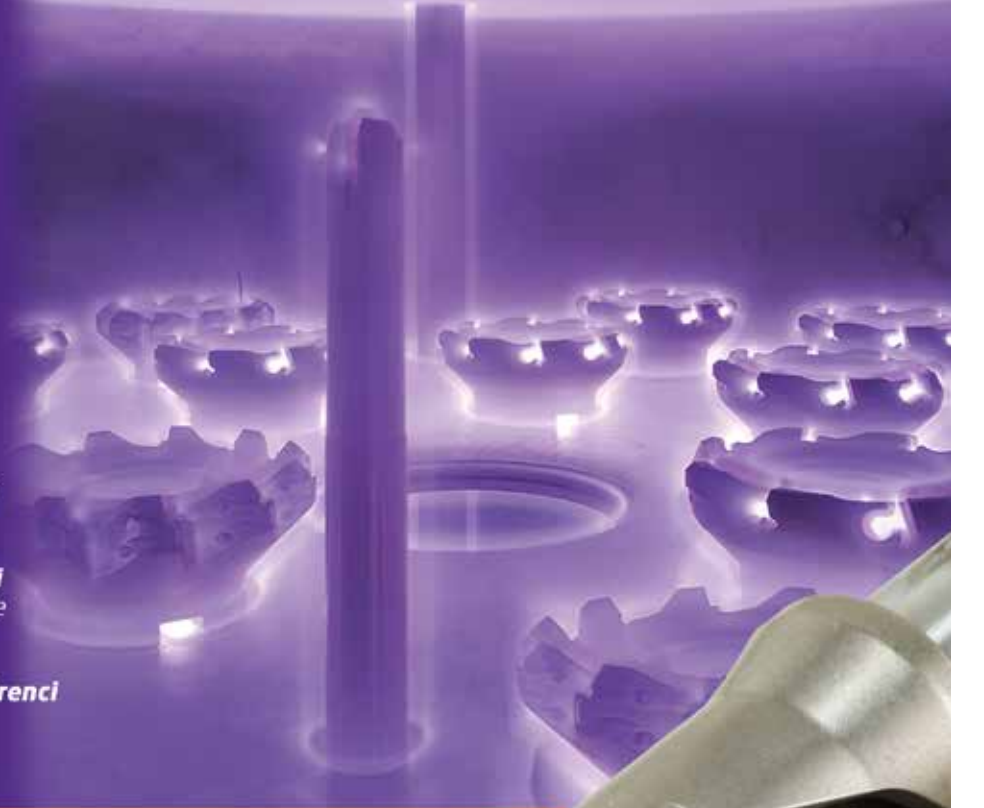

takımınız neden
daha uzun ömürlü
olmasın?...

longer tool life...



α Çevre Dostudur. α is friend of environment.

İnsan sağlığı açısından zararlı değildir. Is not harmful to human health.

Gaz ve diğer atıkları çevreyi kirlilemez. Gas and other wastes will not pollute the environment.

konusulan
the spoken *kalite...*
quality...



konusulan
the spoken kalite...
quality...



konusulan
the spoken kalite...
quality...



NOT / NOTE :

A series of horizontal dashed lines for writing.



Konya Organize Sanayi Bölgesi
Işıktepe Sk. No:6 P.K. 42250
Selçuklu / KONYA / TÜRKİYE

Tel : +90 332 239 17 57 (pbx)
Fax: +90 332 239 17 52
GPS: 37.973262 N / 32.604158 E

www.akkо.com.tr
akkо@akkо.com.tr
export@akkо.com.tr

